



**BMW  
MOTORRAD**

# **ORIGINAL BMW MOTORRAD ACCESSORIES**



**MAKE LIFE A RIDE**

---



# ORIGINAL BMW MOTORRAD ACCESSORIES

<b>40 YEARS OF GS ACCESSORIES</b>	<b>4</b>
<b>CURRENT MODELS</b>	<b>8</b>
HERITAGE	8
SPORT	34
URBAN MOBILITY	58
TOUR	92
ROADSTER	142
ADVENTURE	190
<b>MODEL-INDEPENDENT ACCESSORIES</b>	<b>304</b>
<b>PREVIOUS MODELS</b>	<b>316</b>
C MODEL RANGE	318
G MODEL RANGE	330
R MODEL RANGE, WATER-COOLED	338
R MODEL RANGE, AIR-COOLED	372
R MODEL RANGE, R NINE T	400
F MODEL RANGE	414
K MODEL RANGE	440
S MODEL RANGE	460





# 40 YEARS OF GS

## 40 YEARS OF ACCESSORIES

When the first G/S (written with a slash back then) hit the roads in 1980, the range of extra accessories was, let's say, fairly modest. A rear axle ratio 3.56, gas pressure shock absorber with extra tank, first aid kit, supertool kit and motocase (right) – and that was it. Today, you can hardly imagine the GS without the amazing range of useful accessories. They belong together, just like the GS and the word 'adventure'.

Whether you're heading off on a long-distance trip, riding off-road, or just going out for a quick spin after work, there's now an extensive range of accessories available – with solutions for every need and every situation. A passionate team of motorcyclists and 40 years of development and production experience make this possible. Best of all, these premium quality accessories are not only available for the latest GS models, there's also a wide selection on offer for predecessor models.

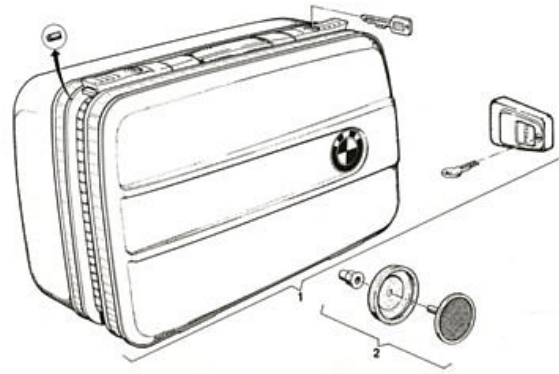



MILLIONS  
OF MILES ON  
THE CLOCK.  
NO TERRAIN  
UNCONQUERED.  
40 YEARS OF  
EXPERIENCE.



**IT'S WHAT'S MADE  
OUR GS ACCESSORIES  
THE PREMIUM  
QUALITY THEY ARE  
TODAY**

For decades, discerning globetrotters have been swearing by the sophisticated solutions for their GS – ranging from performance-enhancing parts and comprehensive storage solutions, to products for better ergonomics and posture. Made exclusively from original Original BMW Motorrad accessories, GS Trophy Bikes are a prime example of this high quality and reliability. In the end, it's this distinctive BMW quality, which exceeds the standards and requirements needed, that convinces motorcyclists every time they're on the road. After all, GS accessories are made to withstand extreme conditions. So if you consider how everything began 40 years ago, there's not much left to say, except: Here's to the next 40 years.



Top picture: BMW R80 G/S: the exclusive pleasure...  
Bottom picture: ...of enjoying your leisure time in your own individual way: BMW R80 G/S.



# HERITAGE

---

**R NINE T DERIVATIVES**

R nine T (model code: 0J01, 0J03), R nine T Pure,  
R nine T Scrambler, R nine T Racer, R nine T Urban G/S

**BE IMPATIENT  
TO GET OUT  
AND GET ON IT.**





# ACCESSORIES FOR BMW R NINE T DERIVATIVES



## HP PARTS

### HP SPORT SILENCER

- Available for:**
- R nineT
  - R nineT Pure
  - R nineT Scrambler
  - R nineT Racer
  - R nineT Urban G/S

A top-class feature: made entirely of titanium, with a carbon end cap and a laser-etched HP logo. The HP sport silencer turns every ride into a thrilling experience. Choose from two positions (standard and raised) and in two colour variants (titanium and black).

Please note the specifications for different countries.  
To be fitted and/or enabled in a specialist workshop, ideally at your authorised BMW Motorrad dealership.

1 HP sport silencer



2 HP sport silencer, black



### HP CARBON BOLT-ON PARTS

**Available for:**

- R nineT
- R nineT Pure
- R nineT Scrambler
- R nineT Racer
- R nineT Urban G/S

Superlative performance is a given with these HP parts. They're elegant, exclusive and durable – each one a masterpiece in its own right. And if perfection's what you're after, you've hit the jackpot here because they're made of carbon, the ultimate lightweight material. An unbeatable combination of stylish looks and technical expertise.

To be fitted and/or enabled in a specialist workshop, ideally at your authorised BMW Motorrad dealership.

- 1 Only available for the BMW R nineT
- 2 Not available for the BMW R nineT & R nineT Urban G/S
- 3 Not available for the BMW R nineT Scrambler
- 8 Not available for the BMW R nineT Scrambler & R nineT Urban G/S  
Only for one-up; the rear bag, seat hump cover and passenger comfort seat cannot be fitted at the same time.

**Padding for seat hump cover (not shown)**  
Not available for the BMW R nineT Scrambler & R nineT Urban G/S

1 HP carbon front wheel cover



2 HP carbon front wheel cover



3 HP carbon belt cover



4 HP carbon cylinder head covers



5 HP carbon cover intake snorkel



6 HP carbon trim for throttle body



7 HP carbon ignition switch/steering lock cover



8 HP carbon seat hump cover



9 Padding for custom seat hump cover





HP PASSENGER FOOTRESTS

Available for:

- R nineT
- R nineT Pure
- R nineT Scrambler
- R nineT Racer
- R nineT Urban G/S

The HP passenger footrests are milled from an anodised aluminium alloy and give the bike an even sportier appearance. Their design makes them very light, but also extremely dimensionally stable so that they provide secure support for the foot at all times.

To be fitted and/or enabled in a specialist workshop, ideally at your authorised BMW Motorrad dealership.

1 HP passenger footrests



2 HP passenger footrest, black



ATTACHMENT SET FOR PASSENGER FRAME  
(NOT SHOWN)

Available for:

- R nineT Racer



STORAGE

TANK BAG / TANK BAG, LEATHER EDITION

Available for:

- R nineT
- R nineT Pure
- R nineT Scrambler
- R nineT Racer
- R nineT Urban G/S

The tank bag made of classic elegant black canvas and waterproof main compartment holds 11 litres. Available in two material/colour combinations.

The tank strap underlines the retro look of the motorcycle and is used to attach the tank bag or small tank bag.

The leather edition tank strap in retro look with anti-slip coating is used to attach the tank bag or small tank bag.

1&2

For information on speed and load limitations, please refer to the instruction booklet.

1 Tank bag, 11l



2 Tank bag, leather edition, 11l



3 Tank belt



4 Tank strap, leather edition





**SMALL TANK BAG/SMALL TANK BAG, LEATHER EDITION**

**Available for:**

- R nineT
- R nineT Pure
- R nineT Scrambler
- R nineT Racer
- R nineT Urban G/S

Small, stylish bag made of black canvas in classic design with 1.5-litre stowage space for various small parts. Available in two material/colour combinations.

Only available in conjunction with tank belt/tank belt leather edition.  
For information on speed and load limitations, please refer to the instruction booklet.

1 Small tank bag, 1.5l



2 Small tank bag, leather edition, 1.5l



**REAR BAG/REAR BAG, LEATHER EDITION**

**Available for:**

- R nineT
- R nineT Pure
- R nineT Scrambler
- R nineT Racer
- R nineT Urban G/S

The waterproof rear bag made of black canvas has style and offers plenty of room for luggage with its 40-litre volume. Two side patch pockets, colour-contrasting straps and brushed metal buckles are a perfect match for the classic design of the Heritage models. Available in two material/colour combinations.

Not available in combination with the luggage carrier, Scrambler single seat, comfort pillion passenger seat, side bag(s) or seat hump cover. For information on individual restrictions regarding travel speed and payload, please refer to the installation/operating instructions.

1 Rear bag, 40l



2 Rear bag, leather edition, 40l



**SIDE BAGS/SIDE BAGS, LEATHER EDITION**

**Available for:**

- R nineT
- R nineT Pure
- R nineT Scrambler
- R nineT Racer
- R nineT Urban G/S

The waterproof side bags in retro style look extremely casual and with their 14-litre (right) or 9-litre (left) capacity offer plenty of storage space for luggage. Under the water-repellent outer fabric made of black canvas, the bag contents stay dry in a waterproof, removable inside pocket with a roll closure. Available in two material/colour combinations.

Not available in conjunction with the rear bag.  
For information on speed and load limitations, please refer to the instruction booklet.

**1 & 3** Only available in conjunction with a low positioned silencer.  
Not available for the BMW R nineT Scrambler.

1 Left side bag, 9l



2 Right side bag, 14l



3 Left side bag, leather edition, 9l



4 Right side bag, leather edition, 14l



**LUGGAGE RACK**

**Available for:**

- R nineT
- R nineT Pure
- R nineT Scrambler
- R nineT Urban G/S

The classic stainless steel luggage rack is the ideal choice for solo riders who, instead of a passenger, want to take more luggage with them.

For solo riding only. Only available in conjunction with the single seat for luggage rack.  
Not available in conjunction with the rear bag.  
To be fitted and/or enabled in a specialist workshop, ideally at your authorised BMW Motorrad dealership.  
The illustrated single seat is not included in the scope of delivery.

Original BMW Motorrad equipment is available from your authorised BMW Motorrad dealership.





# DESIGN

## OPTION 719 CLASSIC MILLED PARTS

**Available for:**

- R nineT
- R nineT Pure
- R nineT Scrambler
- R nineT Racer
- R nineT Urban G/S

The exclusive Option 719 Classic milled parts set design accents with high-quality components in a silver look. The milled Spezial parts made of anodised aluminium show a lot of love for detail and create an exclusive value. Option 719 branding also emphasises the quality appeal of the bike. All milled parts are perfectly matched to each other and harmonise optimally with the vehicle design. In a complex manufacturing process, components such as hand levers and footrests are milled from solid metal. The cylinder head covers, the front engine housing cover and the mirrors are made from a forging blank. All parts are manufactured according to strict BMW quality guidelines. They therefore meet the highest standards and are characterised by a perfect fit.

To be fitted and/or enabled in a specialist workshop, ideally at your authorised BMW Motorrad dealership.

1 Option 719 Classic oil filler plug



2 Option 719 Classic covers for expansion tank



3 Option 719 Classic passenger footrests



4 Option 719 Classic rider footrest system  
Not shown for racer



5 Option 719 Classic adjustable hand lever



6 Option 719 Class belt cover



7 Option 719 Classic seat bracket



8 Option 719 Classic cylinder head covers



## OPTION 719 CLUB SPORT MILLED PARTS

**Available for:**

- R nineT
- R nineT Pure
- R nineT Scrambler
- R nineT Racer
- R nineT Urban G/S

The Option 719 Club Sport milled parts with their interplay of black and gold anodising give your motorcycle a dark character with a sophisticated appearance. The individual parts are elaborately manufactured from aluminium forged blanks. They impress with design-defining milling contours worked out with great attention to detail. The Option 719 insignia, also milled, underlines the exclusivity and contributes to the overall aesthetics. The anodised coating not only gives the milled parts their characteristic colour but also serves as surface protection. All milled parts are manufactured to the highest BMW motorcycle standards in top quality.

To be fitted and/or enabled in a specialist workshop, ideally at your authorised BMW Motorrad dealership.

1 Option 719 Club Sport oil filler plug



2 Option 719 Club Sport expansion tank covers



3 Option 719 Club Sport rear footrests



4 Option 719 Club Sport rider footrest system  
Not shown for racer



5 Option 719 Club Sport adjustable hand lever



6 Option 719 Club Sport belt cover



7 Option 719 Club Sport seat bracket



8 Option 719 Club Sport cylinder head covers



Original BMW Motorrad equipment is available from your authorised BMW Motorrad dealership.



OPTION 719 STORM MILLED PARTS

Available for:

- R nineT
- R nineT Pure
- R nineT Scrambler
- R nineT Racer
- R nineT Urban G/S

The exclusive Option 719 Storm milled parts add design highlights with high-quality components in a silver-grey rough look. The milled Spezial parts made of anodised aluminium show a lot of love for detail and create an exclusive value.

Option 719 branding also emphasises the quality appeal of the bike. All milled parts are perfectly matched to each other and harmonise optimally with the vehicle design. In a complex manufacturing process, components such as the hand levers are milled from solid metal. The cylinder head covers and the front engine housing cover are made from a forging blank. All parts are manufactured according to strict BMW quality guidelines. They therefore meet the highest standards and are characterised by a perfect fit.

To be fitted and/or enabled in a specialist workshop, ideally at your authorised BMW Motorrad dealership.

1 Option 719 Storm oil filler plug



2 Option 719 Storm covers for expansion tank



3 Option 719 Storm rear footrests



4 Option 719 Storm rider footrest system  
Not shown for racer



5 Option 719 Storm adjustable hand lever



6 Option 719 Storm belt cover



7 Option 719 Storm seat bracket



8 Option 719 Storm cylinder head covers



BMW MOTORRAD MACHINED PARTS

Available for:

- R nineT
- R nineT Pure
- R nineT Scrambler
- R nineT Racer
- R nineT Urban G/S

Each unique, lovingly crafted BMW Motorrad Machined Part is designed to make the BMW R nineT even more stunning. The designs are the result of close collaboration with Roland Sands, the Californian designer, trendsetter and customization expert. All BMW Motorrad Machined Parts also feature the "by Roland Sands Design" signature logo. The high-quality surfaces of these aluminium parts boast bold contrasts in Glossy Black and are produced in a series of complex processing steps, some of which are performed manually. All BMW Motorrad Machined Parts can be combined with the full range of Original BMW Motorcycle Equipment, allowing you to transform the BMW R nineT into your own ultra-personalized ride.

To be fitted and/or enabled in a specialist workshop, ideally at your authorised BMW Motorrad dealership.

- 1 Not available for the BMW R nineT Racer
- 2 Not available for the BMW R nineT Urban G / S

1 Machined handlebar clamp



2 Machined headlight cover



3 Machined belt cover



4 Machined oil filler neck cover



5 Machined handlebar end cover



6 Machined rear axle cover



7 Machined angular gear bearing cover



8 Machined swing arm bearing cover



9 Machined front brake fluid tank cover



10 Machined clutch fluid container cover



11 Machined cylinder head covers





MILLED FOOTREST SYSTEM



Available for:

- R nineT
- R nineT Pure
- R nineT Scrambler
- R nineT Urban G/S

The CNC-milled footrest system enhances the dynamic look of the motorcycle. The ribbed tread surface provides a secure base for the rider's feet, ensuring optimum control of the bike. A wide range of adjustment options offer riders everything they need when it comes to ergonomics and track-style riding.

To be fitted and/or enabled in a specialist workshop, ideally at your authorised BMW Motorrad dealership.

MILLED HANDBRAKE LEVER / CLUTCH LEVER



Available for:

- R nineT
- R nineT Pure
- R nineT Scrambler
- R nineT Racer
- R nineT Urban G/S

The ergonomically optimised hand levers made of black anodised aluminium are adjustable and underline the individuality of the bike.

To be fitted and/or enabled in a specialist workshop, ideally at your authorised BMW Motorrad dealership.

CHROME-PLATED EXHAUST MANIFOLD



Available for:

- R nineT
- R nineT Pure
- R nineT Scrambler
- R nineT Racer
- R nineT Urban G/S

The chrome-plated exhaust manifold gives the standard silencer or the HP sport silencer a special touch.

To be fitted and/or enabled in a specialist workshop, ideally at your authorised BMW Motorrad dealership.

R NINET SILENCER



Available for:

- R nineT
- R nineT Pure
- R nineT Scrambler
- R nineT Racer
- R nineT Urban G/S

The R nineT's double-flow rear silencer can also be used to customise the appearance of other Heritage models.

To be fitted and/or enabled in a specialist workshop, ideally at your authorised BMW Motorrad dealership.

SCRAMBLER SILENCER



Available for:

- R nineT
- R nineT Pure
- R nineT Scrambler
- R nineT Racer
- R nineT Urban G/S

The Scrambler's double-flow standard silencer can also be used to visually upgrade other Heritage models.

Note differences in national-market versions. Not available in conjunction with the passenger frame. Only available in conjunction with the Scrambler silencer bracket (without passenger frame). To be fitted and/or enabled in a specialist workshop, ideally at your authorised BMW Motorrad dealership.

SILENCER BRACKET



Available for:

- R nineT
- R nineT Pure
- R nineT Scrambler
- R nineT Racer
- R nineT Urban G/S

The holder is for attaching the Scrambler silencer with the passenger frame removed.

REV COUNTER INCL. ON-BOARD COMPUTER



Available for:

- R nineT
- R nineT Pure
- R nineT Scrambler
- R nineT Racer

The rev counter with gear indicator and on-board computer perfectly complements the standard speedometer and provides a lot of useful additional information.

To be fitted and/or enabled in a specialist workshop, ideally at your authorised BMW Motorrad dealership.

INSTRUMENT CLUSTER HOUSING, MATT, CHROME-PLATED



Available for:

- R nineT
- R nineT Pure
- R nineT Scrambler
- R nineT Racer
- R nineT Urban G / S

The matt chrome housing for the instrument cluster adds an attractive highlight in the cockpit area.

To be fitted and/or enabled in a specialist workshop, ideally at your authorised BMW Motorrad dealership.

ALUMINIUM WINDSCREEN HAND-BRUSHED



Available for:

- R nineT
- R nineT Pure
- R nineT Scrambler

The high-quality aluminium windscreen, hand-brushed impressively emphasises the bike's classic Roadster design with its retro look.

Please note the specifications for different countries.

SCRAMBLER WINDSCREEN ALPINE WHITE



Available for:

- R nineT
- R nineT Pure
- R nineT Scrambler

The windscreen in the design of a classic race number plate has style and offers protection from oncoming wind.

Please note the specifications for different countries.

ALUMINIUM RADIATOR GRILLE, HAND-BRUSHED



Available for:

- R nineT
- R nineT Pure
- R nineT Scrambler
- R nineT Racer
- R nineT Urban G/S

The hand-brushed aluminium radiator cowls ensure a harmonious and high-quality appearance in the side view while fully maintaining the cooling capacity.

To be fitted and/or enabled in a specialist workshop, ideally at your authorised BMW Motorrad dealership.

ALUMINIUM SEAT HUMP COVER



Available for:

- R nineT
- R nineT Pure
- R nineT Racer

The aluminium seat hump cover is fitted in place of the passenger seat, and includes a small, spray-water protected storage compartment. The high-quality backrest pad ensures enhanced rider comfort and finishes the look visually.

Available as aluminium seat hump cover and hand-brushed aluminium seat hump cover.

Only for one-up.



**CYLINDER HEAD COVERS**

**Available for:**  
 • R nineT  
 • R nineT Pure  
 • R nineT Scrambler  
 • R nineT Racer  
 • R nineT Urban G/S

Different colours provide even more ways to personalize your BMW.  
 Whichever you choose, these variants in Black, Silver and Chrome will give your motorcycle that extra-special something.  
 To be fitted and/or enabled in a specialist workshop, and ideally at your authorised BMW Motorrad dealership.

**1 Cylinder head cover, 2V style**



**2 Cylinder head cover, silver**



**3 Cylinder head cover, black**



**4 Chrome-plated cylinder head covers**



**HAND-BRUSHED ALUMINIUM TANK, WITH VISIBLE WELD SEAM**



**Available for:**  
 • R nineT  
 • R nineT Pure  
 • R nineT Scrambler  
 • R nineT Racer  
 • R nineT Urban G/S

Thanks to its unique surface structure, the hand-brushed aluminium tank is particularly elegant and exclusive.

To be fitted and/or enabled in a specialist workshop, ideally at your authorised BMW Motorrad dealership.

**ALUMINIUM TANK, HAND-BRUSHED, WITH GROUND-DOWN WELD SEAM**



**Available for:**  
 • R nineT  
 • R nineT Pure  
 • R nineT Scrambler  
 • R nineT Racer  
 • R nineT Urban G / S

Thanks to its unique surface structure, the hand-brushed aluminium tank is particularly elegant and exclusive.

To be fitted and/or enabled in a specialist workshop, ideally at your authorised BMW Motorrad dealership.

**R NINE T SPOKE WHEEL**

**Available for:**  
 • R nineT  
 • R nineT Pure  
 • R nineT Racer

Timeless beauty: The high-quality spoke wheel of the BMW R nineT also helps to customise other model variants and perfect the classic Heritage look. The centrally spoked 5.5x17" (rear) or 3.5x17" (front) steel wheel must be combined with a tubular tyre.

To be fitted and/or enabled in a specialist workshop, ideally at your authorised BMW Motorrad dealership.

**1 Front**



**2 Rear**



**CROSS-SPOKED WHEELS**

**Available for:**  
 • R nineT Scrambler  
 • R nineT Urban G / S

The black anodised cross-spoked wheel is fully off-road-capable and perfects the classic Scrambler look.

Not available in conjunction with lowered suspension as an optional extra (OE 0499). To be fitted and/or enabled in a specialist workshop, ideally at your authorised BMW Motorrad dealership.

**1 Front**



**2 Rear**



**HANDLEBAR END COVER**



**Available for:**  
 • R nineT  
 • R nineT Pure  
 • R nineT Scrambler  
 • R nineT Racer  
 • R nineT Urban G/S

The covers for the handlebar ends of the BMW R nineT in silver are a visual highlight and emphasise the individual character of the motorcycle.

To be fitted and/or enabled in a specialist workshop, ideally at your authorised BMW Motorrad dealership.

**RACE NUMBER PLATES, ALPINE WHITE**



**Available for:**  
 • R nineT  
 • R nineT Pure  
 • R nineT Scrambler  
 • R nineT Racer  
 • R nineT Urban G/S

The race number plates in Alpine white are placed under the seat and can be glued on individually for the ultimate Café Racer look.

To be fitted and/or enabled in a specialist workshop, ideally at your authorised BMW Motorrad dealership.



**CLASSIC EMBLEM**

**Available for:**

- R nineT
- R nineT Pure
- R nineT Scrambler
- R nineT Urban G/S

The Classic emblem is reminiscent of the good old days and perfects the Heritage look.

To be fitted and/or enabled in a specialist workshop, ideally at your authorised BMW Motorrad dealership.



**LED TURN INDICATORS**

**Available for:**

- R nineT
- R nineT Pure
- R nineT Scrambler
- R nineT Racer
- R nineT Urban G/S

A shining example: the beautifully designed LED indicators with white turn indicator glass convince with their slim design and modern lighting technology. They respond much faster than incandescent lamps and are virtually wear-free. This provides a clear safety advantage in road traffic.

Note the differences in national-market versions. To be fitted and/or enabled in a specialist workshop, ideally at your authorised BMW Motorrad dealership.



**KNEE PADS**

**Available for:**

- R nineT
- R nineT Pure
- R nineT Scrambler
- R nineT Racer
- R nineT Urban G/S

The ergonomically shaped knee pads made of black rubber protect the tank against scratches on both sides.

To be fitted and/or enabled in a specialist workshop, ideally at your authorised BMW Motorrad dealership.



**DOUBLE INSTRUMENT CLUSTER HOLDER (NOT SHOWN)**

**Available for:**

- R nineT Pure
- R nineT Scrambler

The black or matt, chrome-plated holder for the twin instrument cluster allows the installation of a rotational-speed sensor.

To be fitted and/or enabled in a specialist workshop, ideally at your authorised BMW Motorrad dealership.

**MAIN FRAME SCREW COVER**

**Available for:**

- R nineT
- R nineT Pure
- R nineT Scrambler
- R nineT Racer
- R nineT Urban G/S

The cover of the main frame screw connection is the elegant solution when the passenger frame is removed. To this end, the open main frame screw is covered with an aluminium double sleeve.

To be fitted and/or enabled in a specialist workshop, ideally at your authorised BMW Motorrad dealership.



**TINTED WINDSCREEN (NOT SHOWN)**

**Available for:**

- R nineT Racer

The tinted windscreen emphasises the sporty look of the motorcycle. The special coating also permanently prevents scratches. The dimensions and shape are identical to the standard windscreen.

Please note the specifications for different countries.

**HAND-BRUSHED ALUMINIUM TRIANGULAR FRAME COVER (NOT SHOWN)**

**Available for:**

- R nineT
- R nineT Pure
- R nineT Scrambler
- R nineT Racer
- R nineT Urban G/S

The hand-brushed aluminium triangular frame cover conceals the plastic intake silencer thus enhancing the bike's look.

**GRANITE GREY IGNITION SWITCH/STEERING LOCK COVER (NOT SHOWN)**

**Available for:**

- R nineT
- R nineT Pure
- R nineT Scrambler
- R nineT Racer
- R nineT Urban G/S

The cover for the ignition switch/steering lock in Granite grey adds a colour highlight.

**CUSTOM MIRROR, CHROME-PLATED**

**Available for:**

- R nineT Pure

To be fitted and/or enabled in a specialist workshop, ideally at your authorised BMW Motorrad dealership.



Original BMW Motorrad equipment is available from your authorised BMW Motorrad dealership.



# ERGONOMICS & COMFORT

## URBAN SEAT IN ESPRESSO BLACK, LOW

NEW

### Available for:

- R nineT
- R nineT Pure
- R nineT Scrambler
- R nineT Urban G/S

The Scrambler seat in Espresso black offers maximum seating comfort. In addition, the high-quality seat with attractive cross stitching and leather appearance gives the Heritage models an individual look.



## URBAN RIDER SEAT IN ESPRESSO BLACK

NEW

### Available for:

- R nineT
- R nineT Pure
- R nineT Scrambler
- R nineT Urban G/S

The classic Scrambler single seat in Espresso black is the stylish solution for everyone who prefers to ride solo.



The single seats are all waterproof and finished to the highest quality. The focus of the design is to provide an authentic look and feel, which is why clothing such as dark jeans may stain the seat. Stains of this kind and other discolourations are considered a desirable patina, and do not constitute defects. Only available in conjunction with rear end trim for Scrambler single seat bench.

## URBAN SEAT IN ESPRESSO BLACK

NEW

### Available for:

- R nineT
- R nineT Pure
- R nineT Scrambler
- R nineT Urban G/S



## SCRAMBLER SINGLE SEAT BENCH, SADDLE BROWN



### Available for:

- R nineT
- R nineT Pure
- R nineT Scrambler
- R nineT Urban G/S

The classic Scrambler single seat in Saddle brown is the stylish solution for everyone who prefers to ride solo.

The single seats are all waterproof and finished to the highest quality. The focus of the design is to provide an authentic look and feel, which is why clothing such as dark jeans may stain the seat. Stains of this kind and other discolourations are considered a desirable patina, and do not constitute defects. Only in conjunction with rear end trim for Scrambler single seat bench.

## SCRAMBLER SEAT, HIGH, SADDLE BROWN



### Available for:

- R nineT Scrambler

This 30mm higher version of the Scrambler seat is particularly suitable for tall riders.

The single seats are all waterproof and finished to the highest quality. The focus of the design is to provide an authentic look and feel, which is why clothing such as dark jeans may stain the seat. Stains of this kind and other discolourations are considered a desirable patina, and do not constitute defects.

## SCRAMBLER SINGLE SEAT REAR SECTION



### Available for:

- R nineT
- R nineT Pure
- R nineT Scrambler
- R nineT Urban G/S

The rear section for the Scrambler single seat stylishly complements the look of the bike with a shorter seat for one-up riding. The black rear section is made from plastic and fits perfectly on the Scrambler single seat.

## PASSENGER COMFORT SEAT, BLACK



### Available for:

- R nineT
- R nineT Pure
- R nineT Scrambler
- R nineT Racer
- R nineT Urban G/S

The wider comfort rear seat with enhanced padding offers the passenger a noticeable increase in seating comfort.



SINGLE SEAT FOR LUGGAGE RACK IN RED OR SADDLE BROWN

Available for:

- R nineT
- R nineT Pure
- R nineT Scrambler
- R nineT Urban G/S

The sporty single seat is a shorter seat for the luggage rack option. Perfect for anyone who likes to enjoy the riding wind alone.

The single seats are all waterproof and finished to the highest quality. The focus of the design is to provide an authentic look and feel, which is why clothing such as dark jeans may stain the seat. Stains of this kind and other discolourations are considered a desirable patina, and do not constitute defects.

1 Red



2 Brown



R NINET RIDER SEAT, BLACK



Available for:

- R nineT
- R nineT Pure
- R nineT Scrambler
- R nineT Urban G/S

The BMW R nineT rider seat in classic black impresses with its attractive design. The high-quality leather-look seat surface and the attractive decorative double stitching in white emphasise the classic look.

R NINET PASSENGER SEAT, BLACK



Available for:

- R nineT
- R nineT Pure
- R nineT Scrambler
- R nineT Racer
- R nineT Urban G/S

The R nineT passenger seat in black ensures a high level of comfort on long journeys with a passenger. It also underlines the dynamic look of the motorcycle.

CUSTOM RIDER'S SEAT, BLACK

Available for:

- R nineT
- R nineT Pure
- R nineT Scrambler
- R nineT Racer
- R nineT Urban G/S

The Custom rider seat in classic black with its discreet cross stitching and details in an Alcantara look sets individual accents. Its exclusive design, the high-quality seat surface, the white double decorative stitching and the embroidered BMW R nineT inscription in gold further enhance the look of the motorcycle.

Not available in conjunction with high-positioned Sports silencer (long crossover pipe).



LOW URBAN G / S SEAT, RED

Available for:

- R nineT
- R nineT Pure
- R nineT Scrambler
- R nineT Urban G/S

The lower Urban G/S seat in red makes it easier to get on and off and improves ground accessibility. The reduced seat height provides a safe feeling for the rider as it makes it easier to manoeuvre and control the bike. The adapted padding ensures that seating comfort is maintained even over long distances.



FORK BRIDGE WITH CLIP-ON HANDLEBARS



Available for:

- R nineT

The fork bridge with fixed clip-on handlebars allows for a clearly front-wheel-oriented seating position for a Café Racer riding style.

To be fitted and/or enabled in a specialist workshop, ideally at your authorised BMW Motorrad dealership.

ADJUSTABLE CLIP-ON HANDLEBARS



Available for:

- R nineT

Clip-ons let you really lean into the front wheel and give your BMW an even more dynamic look.

To be fitted and/or enabled in a specialist workshop, ideally at your authorised BMW Motorrad dealership.



**FORK BRIDGE  
(NOT SHOWN)**

**Available for:**  
• R nineT Pure

The fork bridge with fixed clip-on handlebars allows for a front-wheel-oriented seating position for sporty riding. The scope of delivery includes the complete mounting kit including brake and clutch line, tank pad and steering angle limiter. An individual TÜV inspection is not necessary, the vehicle warranty remains fully valid.

To be fitted and/or enabled in a specialist workshop, ideally at your authorised BMW Motorrad dealership.

**FORK BRIDGE WITH CLIP-ON  
HANDLEBARS AND ROTATIONAL-  
SPEED SENSOR, TOP**

**Available for:**  
• R nineT Pure

The fork bridge with fixed clip-on handlebars and rotational-speed sensor allows for a clearly front-wheel-oriented seating position for a Café Racer riding style.

To be fitted and/or enabled in a specialist workshop, ideally at your authorised BMW Motorrad dealership.



**HEATED GRIPS AND SWITCHES  
(NOT SHOWN)**

**Available for:**  
• R nineT  
• R nineT Pure  
• R nineT Scrambler  
• R nineT Racer  
• R nineT Urban G/S

To be fitted and/or enabled in a specialist workshop, ideally at your authorised BMW Motorrad dealership.

**STEERING LOCK LIMITER  
(NOT SHOWN)**

**Available for:**  
• R nineT Pure

The steering lock limiter prevents the clip-on handlebars from coming into contact with the fuel tank at the maximum steering angle.

To be fitted and/or enabled in a specialist workshop, ideally at your authorised BMW Motorrad dealership.



# NAVIGATION & COMMUNICATION

**BMW MOTORRAD NAVIGATOR VI**

**Available for:**

- R nineT
- R nineT Pure
- R nineT Scrambler
- R nineT Racer
- R nineT Urban G/S

The multifunctional BMW Motorrad Navigator VI without pre-installed maps makes route planning child's play. The system with 4 GB flash memory and five-inch touch screen always gives the right directions, and the waterproof display is easy to read even in direct sunlight owing to the circular polarisation filter. The high-resolution screen provides all the essential information and ensures that you can see the big picture required in every situation. Numerous additional functions make planning and touring an exciting experience. Plan your routes can be created according to your personal preferences and enjoy driving on winding and quiet side roads. The rider can also preset route guidance to avoid certain roads, e.g. A-roads. In unknown terrain, the "round trip" option is a good choice as it reliably guides the rider at the end of the tour back to the starting point. The Bluetooth connection to the BMW Motorrad communication system and the optional Smartphone Link app enable multimedia on the go: navigation announcements, telephone calls and music streaming as well as the retrieval of weather forecasts or traffic jam information are no problem. Navigation preparation adds further functions such as "My Motorcycle", and the multi-controller on the handlebars offers an alternative control option. The desired map material can simply be installed on the Navigator using an SD card.

Please note the specifications for different countries.



**BMW MOTORRAD SMARTPHONE CRADLE**

**Available for:**

- R nineT
- R nineT Pure
- R nineT Scrambler
- R nineT Racer
- R nineT Urban G/S

BMW Motorrad's robust smartphone cradle provides a safe and protected place for your smartphone. This means that useful functions such as navigation information and online information can also be used while you are on the move. Thanks to the handy charging function, your smartphone is also always ready for action on extended bike tours.

Only in combination with bracket for BMW Motorrad navigation devices.





# SAFETY

## ALUMINIUM CYLINDER-HEAD COVER PLATE



**Available for:**

- R nineT
- R nineT Pure
- R nineT Scrambler
- R nineT Racer
- R nineT Urban G/S

The cylinder head cover guard, made of anodised aluminium, protects the cylinder head against damage and makes the look of the motorcycle more striking.

To be fitted and/or enabled in a specialist workshop, ideally at your authorised BMW Motorrad dealership.

## PLASTIC CYLINDER-HEAD COVER PLATE



**Available for:**

- R nineT
- R nineT Pure
- R nineT Scrambler
- R nineT Racer
- R nineT Urban G/S

The glass-fibre reinforced plastic cylinder head cover guard protects the cylinder head from damage and emphasises the design of the boxer engine.

To be fitted and/or enabled in a specialist workshop, ideally at your authorised BMW Motorrad dealership.

## ALUMINIUM ENGINE GUARD

**Available for:**

- R nineT Scrambler
- R nineT Urban G/S

The robust aluminium engine guard effectively protects the lower area against stone chips and damage, for example, when bottoming out. Nothing stands in the way of an off-road excursion. Street riders will also appreciate the discreet off-road look.

To be fitted and/or enabled in a specialist workshop, ideally at your authorised BMW Motorrad dealership.



## HIGH-END STEERING DAMPER SET

**Available for:**

- R nineT
- R nineT Pure
- R nineT Scrambler
- R nineT Racer
- R nineT Urban G/S

Maximum control and safety not only on fast tracks: the HP steering damper with gold-coloured surface is a genuine high-end product. It responds sensitively and, with 12 clicks, offers a wide adjustment range to suit different track conditions and individual operating conditions.



## HAND PROTECTORS



**Available for:**

- R nineT
- R nineT Pure
- R nineT Scrambler
- R nineT Urban G/S

The robust hand protector gives the motorcycle a sporty look and reliably protects the hands from wind, weather, branches and flying stones.

To be fitted and/or enabled in a specialist workshop, ideally at your authorised BMW Motorrad dealership.

## PROTECTIVE GRILLE FOR HEADLIGHT



**Available for:**

- R nineT
- R nineT Pure
- R nineT Scrambler

The perfect addition whenever the rider goes off-road: The protective grille for the headlight prevents damage from stone chips or branches when riding off public roads. The grille made of black painted sheet steel is intended exclusively for off-road use.

Please note the specifications for different countries.

## SAFETY SCREW FOR OIL FILLER CAP

**Available for:**

- R nineT
- R nineT Pure
- R nineT Scrambler
- R nineT Racer
- R nineT Urban G/S

The safety screw for the oil filler cap protects against theft and foreign substances in the oil. It also gives an individual look.



## ENGINE PROTECTION BAR (NOT SHOWN)

**Available for:**

- R nineT
- R nineT Pure
- R nineT Scrambler
- R nineT Urban G/S

The two-piece engine protection bar, made of electrically polished stainless steel, reliably protects the cylinder area against damage without restricting the rider's freedom to lean the bike. The robust tube construction to prevent major fall damage can be perfectly combined with the plastic cylinder head cover guard.

## ANTI-THEFT ALARM SYSTEM RETROFIT SET (NOT SHOWN)

NEW

**Available for:**

- R nineT
- R nineT Pure
- R nineT Scrambler
- R nineT Racer
- R nineT Urban G/S

If the Anti-theft Alarm System is moved or struck violently, the system responds with a clearly audible signal and a hazard warning indicator lamp.



# SPORT

S 1000 RR  
Model codes 0E21, 0E23

36 R1250 RS

46

**LEAN INTO EVERY  
CURVE. AND COME OUT  
WITH EVEN MORE  
SPEED.**





# ACCESSORIES FOR BMW S 1000 RR



## M PERFORMANCE PARTS

### M RIDER FOOTRESTS AND M PASSENGER FOOTRESTS

The M rider footrest system provides optimum ergonomics and sportiness thanks to its dynamic look and many adjustment options.

The M passenger footrests (not shown) are milled from an anodised aluminium alloy and give the bike an even sportier appearance.



### FOLDING M CLUTCH LEVER/BRAKE LEVER

The CNC-milled M clutch lever and handbrake lever made of corrosion-resistant anodised aluminium emphasise the motorbike's sportiness in a particularly impressive manner. They are perfectly matched to the bike design and folds upwards reversibly, which reduces the risk of bending or breaking in the event of a fall.

1 Folding M handbrake lever



2 Folding M clutch lever



### M CLUTCH LEVER PROTECTOR/BRAKE LEVER PROTECTOR

Essential on the race track, the M clutch lever protector and M handbrake lever protector are also a clear statement of uncompromising sportiness on the road. The curved bows made of aluminium and plastic protect the clutch lever and brake lever on the handlebars from being unintentionally actuated due to contact with another vehicle.

1 M handbrake lever protector



2 M clutch lever protector



### M ENGINE PROTECTORS

The M engine protector from BMW Motorrad is made of aluminium and equipped with a replaceable plastic slip pad. It protects the engine from direct grinding on the asphalt in extreme cornering situations and thus reliably prevents the engine components from being ground to the core as well as the engine from being damaged as a result.

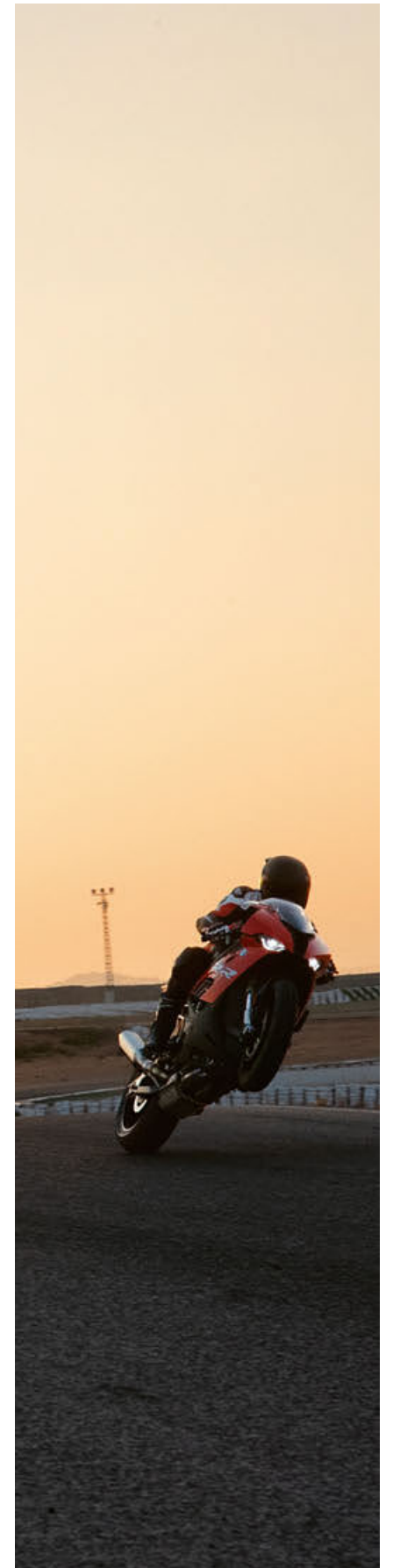
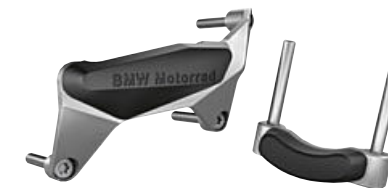



M AXLE PROTECTORS



The M axle protectors from BMW Motorrad protect the fork and swinging arm of the rear axle from scratches if the bike falls or tips over. The robust drop-protection pads are made of highly abrasion-resistant plastic and can take a lot if necessary. In the typical M look, they match the bike's design perfectly.



M CARBON BOLT-ON PARTS

M carbon parts are lightweight and give the bike an even sportier racing look.

1 M carbon front wheel cover



2 M carbon rear wheel cover



3 M carbon top fairing side panel



4 M carbon tank trim



5 M carbon airbox cover



6 M carbon chain guard



7 M carbon pinion cover



USEFUL GEAR FOR THE RACETRACK

When riders prepare their bikes for the race track, mirrors are needed just as little as licence plate holders. The body openings resulting from their removal are perfectly sealed by the high-quality covers in the M cover kit from BMW Motorrad.

Thus the front fairing is mounted optimally again.

The M data logger from BMW Motorrad was specially developed for optimising performance on the race track. It stores in detail all the important riding data

from speed to lean angle on 32 data channels. The data can be transferred to the PC and analysed using the corresponding software.

Expected availability: from Q3/2020.

1 M cover kit



2 M data logger



USEFUL GEAR (ON AND OFF THE TRACK)

The M remote adjuster for the handbrake was developed for the race track and allows easy remote adjustment of the braking pressure while riding.

firm foam, it gives the rider optimum grip in the chase for the all-important tenths of a second.

The M seat was specially designed for the race track and enables fatigue-free riding thanks to maximum feedback. With its particularly non-slip upper material and

To be fitted and/or enabled in a specialist workshop, ideally at your authorised BMW Motorrad dealership.

- 1 Seat height 824 mm, inner leg curve 1,827 mm
- 2 Seat height 849 mm, inner leg curve 1,867 mm
- 3 Seat height 814 mm, inner leg curve 1,809 mm

1 M seat



2 M seat, high



3 M seat, low



4 M remote brake lever adjuster



**M OIL FILLER NECK**



The M oil filler neck milled from black anodised aluminium has a white lasered M logo and highlights the sporty design with its look. The sealing cap has three bore holes which ensure an anti-twist protection for the race track.

**M CARBON WHEELS**

The ultimate high-tech feature. The M carbon rear wheels give the motorbike maximum riding dynamics and handling comfort on the road. The ultra-light carbon rims are each more than 2.5 kg lighter than the standard wheels, have significantly lower gyroscopic forces and make it easier and quicker to quick-turn the bike from one side to the other.

**1 M carbon wheel, front**



**2 M carbon wheel, rear**



**M ASSEMBLY STAND MOUNTING**

The M assembly stand mounting enables use of the rear sport assembly stand. The high-quality swinging arm adapters are simply mounted on the rear of the swinging arm and can also remain on the motorcycle while riding. With their M look, they fit perfectly into the sporty design of the bike.



**M FORGED WHEELS**

The forged aluminium wheels are black anodised and available in the wheel size 120/70 ZR 17 at the front and 200/55 ZR 17 at the rear. With 5 mm brake discs, they offer maximum braking performance and ensure a noticeable improvement in riding performance due to their low oscillating mass - on the racetrack as well as in road traffic.

**1 M forged wheel, front**



**2 M forged wheel, rear**



**M FORK CLAMP FOR CLIP-ON HANDLEBARS (NOT SHOWN)**

The high-quality M fork clamps from BMW Motorrad make it possible to mount clip-on handlebars. The clamps are milled from a high-strength aluminium alloy and therefore especially lightweight while remaining absolutely dimensionally stable. An anodised finish ensures optimal corrosion protection in wind and weather.

**M LITHIUM ION BATTERY (NOT SHOWN)**

High battery power and low weight – the high-quality M battery featuring the latest lithium-ion technology weighs only 1,288 g, a full 2,000 g lighter than the standard battery. The perfect starting aid for ambitious Superbike riders who want to invest in every single gram on their motorcycle.

STORAGE

**TANK BAG, 10 L**



The 10-litre tank bag from BMW Motorrad with belt attachment integrates perfectly into the bike's racing design. It does not slip and thanks to its volume that can be expanded from 6 to 10 litres, it has sufficient storage space in its waterproof, removable liner for the most important travel items.

**TANK BAG, 1.5 L**



The BMW Motorrad 1.5-litre tank bag can be attached to fit on the tank cover with Tenax quick-release fasteners and integrates perfectly into the bike's racing design. It does not slip and offers 1.5 litres of storage space in its waterproof, removable liner for the most important travel items.

**BAG FOR PASSENGER SEAT, 10 L**



The 10-litre BMW Motorrad passenger seat bag is perfectly adapted to the bike's racing design. It can be fitted precisely on the passenger seat without special brackets, remains dimensionally stable and the volume can be extended from 7 to 10 litres for more luggage - well protected in the waterproof liner.

Not with a seat hump. Use only with passenger seat.

**REAR BAG, 20 L**



The 20-litre BMW Motorrad rear bag is perfectly adapted to the bike's racing design. It can be fitted precisely on the passenger seat without special brackets and remains dimensionally stable. The luggage remains well protected in the waterproof removable liner even in wind and weather.

Not with a seat hump. Use only with passenger seat.

**SADDLEBAG, 21 L**



The saddlebags from BMW Motorrad fit perfectly into the sporty design of the bike. They can carry quite a bit of luggage in their waterproof liner. If required, the black bags including spacers can be removed quickly and easily thanks to the Quick-Lock fasteners.

Not with a seat hump. Use only with passenger seat.



# DESIGN

**TANK PAD** NEW

The self-adhesive tank pad absolutely reliably protects the fuel tank from scratches on the paintwork and impressively emphasises the bike's racing look with its dynamic form. It is heat, moisture and water resistant and has a strong, UV-resistant protective layer.



**RR STICKER SET** NEW

The decorative sticker set of the S 1000 RR is perfectly tailored to the motorcycle and adds to the unique look. The colours white, yellow, black and silver grey for trim panel and rims match perfectly with the base coat in Racing red.



**SPORTS SILENCER**

A top-class feature for top quality sound. The sport silencer is made of high-quality materials and is characterised by a throaty sound and an attractive sporty appearance. The sport silencer is manufactured entirely from titanium. This slip-on silencer developed with Akrapovič is also equipped with a carbon end cap. In addition to the visual and acoustic appeal, the use of exclusive materials results in a weight advantage over the standard silencer. Power and torque are the same as the standard configuration. The side face of the sport silencer has a lasered Akrapovič inscription.



# ERGONOMICS & COMFORT

**TINTED WINDSCREEN**

The tinted windscreen emphasises the sporty look of the motorcycle. The scratch-resistant coating ensures long-term unimpeded visibility.



**HIGH WINDSCREEN**

The BMW Motorrad high windscreen has the typical racing dome shape and is approx. 53 mm higher than the standard windscreen. It provides the rider with significantly better wind protection when riding in a horizontal position and, by reducing air resistance, also enables a noticeable increase in top speed.



**HIGH WINDSCREEN, TINTED**

The dome shaped, tinted high windscreen from BMW Motorrad increases wind protection and top speed in equal measure.



**PASSENGER SEAT**

The standard black passenger seat offers pleasant seating and fatigue-free comfort for the passenger even on longer tours.



**PRO RIDING MODES RETROFIT SET (NOT SHOWN)**

Pro riding modes make the bike fully race-ready with three additional RACE Pro modes and many racing extras. In addition to the individually configurable modes, they include three additional Core Ride Screens and extras such as Launch Control, Pit Lane Limiter, Hill Start Control Pro, Dynamic Brake Control and DTC Shift with Slide Control.

**HEATED GRIPS AND SWITCHES (NOT SHOWN)**

No more cold hands: this is ensured by the electric heated grips with multi-stage control. They increase comfort and at the same time bring more safety, because with warm hands and more feeling in their fingers, the rider simply has better control of the motorcycle - on cold days as well as when riding in the rain.

To be fitted and/or enabled in a specialist workshop, ideally at your authorised BMW Motorrad dealership.



**ACTIVATION CODE FOR  
SHIFT ASSISTANT PRO  
(NOT SHOWN)**

The shift assistant Pro allows shifting up and down in almost all load ranges and engine speed ranges without clutch control. The assistant thus ensures noticeably reduced shifting times, a relief of the clutch hand and thus more comfort, dynamics and riding pleasure.

# SAFETY

**PROTECTIVE GLASS FOR  
6.5-INCH TFT DISPLAY**



The protective glass reliably protects the 6.5 inch TFT display from damage. The tempered glass has an anti-glare and anti-reflective surface, so that it is still easy to read the TFT display. With BMW Motorrad inscription.

**RADIATOR GRILLE**

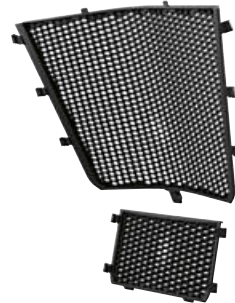

The BMW Motorrad radiator grille reliably protects the radiator on the race track from tyre abrasion and damage due to stone chips. The two-piece polyamide grille fits the upper water cooler and the lower oil cooler exactly and its design matches the aerodynamics of the motorcycle perfectly.

**TYRE PRESSURE CONTROL RETROFIT  
SET (NOT SHOWN)**

Tyre Pressure Control (TPC) with all functions can be retrofitted by installing the control unit. TPC provides reliable information about the current tyre pressure and warns the rider about pressure loss at an early stage. The corresponding notifications and instructions are provided by the on-board computer in the cockpit.

To be fitted and/or enabled in a specialist workshop, ideally at your authorised BMW Motorrad dealership.

**CRUISE CONTROL  
RETROFITTING  
(NOT SHOWN)**

The electronic cruise control can be activated from 30km/h and keeps the driving speed constant. This makes it possible to enjoy longer motorway stretches in a relaxed style. The function is deactivated on braking, and the selected speed is automatically adopted after activating the resume button.

**ANTI-THEFT ALARM SYSTEM  
RETROFIT SET  
(NOT SHOWN)**

The anti-theft alarm system reacts to changes in position and vibrations with an acoustic signal and flashing warning lights system. Thanks to the warning, passers-by quickly become aware. The Anti-theft Alarm System is activated automatically when the ignition is switched off; an additional remote control is not required.

Note the differences in national-market versions.  
To be fitted and/or enabled in a specialist workshop,  
ideally at your authorised BMW Motorrad dealership.





# ACCESSORIES FOR BMW R 1250 RS



## HP PARTS

### HP SPORT SILENCER



Made entirely out of titanium and stainless steel and to an exceptional level of craftsmanship, this slip-on silencer delivers a powerful rumble. It's also remarkably lightweight.

To be fitted and/or enabled in a specialist workshop, ideally at your authorised BMW Motorrad dealership. Mounting instructions are available from your authorised BMW Motorrad dealership.

### HP HAND LEVER, ADJUSTABLE



The CNC-milled HP hand levers made of anodised aluminium combine functionality and aesthetics. The grip width can be adjusted in five steps (brake lever) or three steps (clutch lever) using a setting screw and thus adapted to individual requirements. The look with HP logo also emphasises the bike's sportiness.

### HP COVERS FOR EXPANSION TANKS



The HP cover for expansion tanks made of anodised aluminium also adds to the bike's sporty character. The high-quality milled cover with HP branding emphasises the high-performance claim and also provides for an attractive customisation of the bike.

### HP RIDER FOOTRESTS, ADJUSTABLE



The HP rider footrests are adjustable in three positions and offer a high level of comfort in addition to ergonomic qualities. The high-quality milled parts made of anodised aluminium can be adapted to a sporty riding style or different rider statures and thus ensure even better control, for example in an inclined position.

### HP FOOT LEVER, ADJUSTABLE



The milled HP foot levers made of anodised aluminium are adjustable and come in sporty black/blue/silver. Adjusted to match, the foot levers can also be operated better and more sensitively when riding on large inclines. The exclusive look with HP logo also emphasises the bike's performance-based character.

### HP ENGINE HOUSING COVER, FRONT



The HP engine housing cover made of anodised aluminium also adds to the bike's sporty character. The high-quality milled cover and HP branding emphasise the high-performance standard and also guarantee an attractive customisation of the bike.

### HP CYLINDER HEAD COVERS



The HP cylinder head covers made of anodised aluminium give the boxer engine an attractive appearance. The high-quality milled covers and HP branding highlight the motorcycle's sporty character. The HP oil filler plug perfectly matches the cylinder head covers.

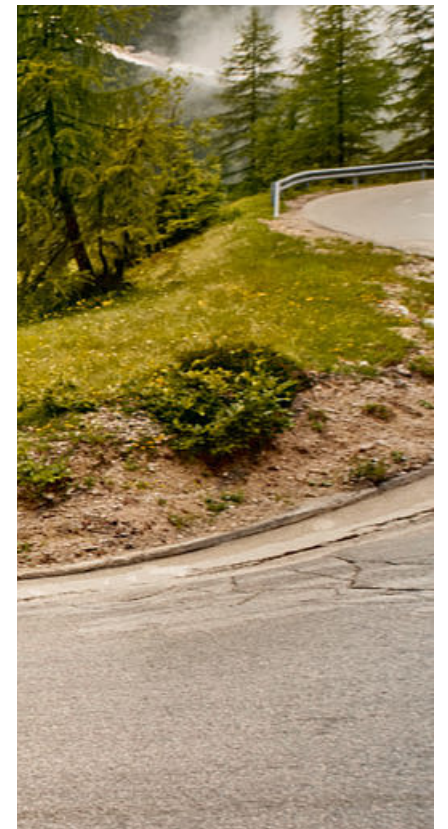



# STORAGE

## TOURING CASES

With a volume of 32 litres, the high-quality hard shell touring case for installation on the left offers ample space for luggage or the motorcycle helmet. The splashproof case with painted lid can be locked and is the perfect travel companion for short or longer tours.

With a volume of 31 litres, the high-quality hard shell touring case for installation on the right offers ample space for luggage. The splashproof case with painted lid can be locked and is the perfect travel companion for short or longer tours.

For information on speed and load restrictions, please refer to the instruction booklet.

1 Touring case in Asphalt grey metallic matt



2 Touring case in Black storm metallic



3 Touring case Granite grey metallic matt



6 Touring case in Light white



## LINERS FOR TOURING CASES

These practical, water-resistant liners make full use of the capacity of the touring cases. Luggage can be accessed easily with one hand, and the bag can even be worn over the shoulder thanks to a detachable strap.



## CASE RACKS

The touring case can be easily and securely attached to the sturdy black powder-coated steel case rack.



## SMALL TOPCASE (30 L) WITH BACKREST PAD

The waterproof topcase has a capacity of 30l and a maximum load of 5 kg – perfect for a helmet, for example. The lid has a smooth painted finish and a soft-close mechanism.

Only in conjunction with luggage carrier, topcase carrier and matching outer shell. For information on speed and load limitations, please refer to the instruction booklet. For more detailed information, contact your authorised BMW Motorrad dealership or go online at [bmw-motorrad.com](http://bmw-motorrad.com).

1 Asphalt grey metallic matt



2 Black Storm metallic



3 Light white



4 Backrest pad for small topcase



## LINER FOR TOPCASE



Makes loading and unloading a topcase even easier. The liner comes with a practical carry handle and can be folded flat when not in use.

## LUGGAGE GRID



The sturdy, stylish luggage carrier is ideal for reliably securing the topcase or other large items of luggage. It acts as a full grip for the passenger and is also ideal for use as a pushing aid when manoeuvring.

## TANK BAG SMALL, 5-9L



The small tank bag made of durable PU-coated polyester fabric is the ideal companion for short trips. The waterproof main compartment with liner, the exterior pocket, the volume that can be expanded from 5 to 9 litres, the carry handle and the removable shoulder strap are functional features that meet all your everyday needs.

## BAG FOR PASSENGER SEAT, 16 L

With a volume of 16 litres, this durable bag for the passenger seat offers enough storage space for the daily ride to work or for day trips. The three-sided zip fastener allows quick access, while the functional carrying handle facilitates transport.





# DESIGN

## OPTION 719 CLASSIC WHEEL

The high-quality Option 719 Classic wheel comes in an attractive bicolour look with elaborate contrast milling. The special workmanship of the cast wheel surface gives the machine an exclusive, high-quality character.

### 1 Option 719 Classic rear wheel



### 2 Option 719 Classic front wheel



## OPTION 719 SPORT WHEEL

The high-quality Option 719 Sport wheel comes in an attractive bicolour look with elaborate contrast milling. The special workmanship of the cast wheel surface gives the machine an exclusive, high-quality character.

### 1 Option 719 Sport rear wheel



### 2 Option 719 Sport front wheel



## REAR-WHEEL COVER

The milled aluminium rear-wheel cover emphasises the dynamic design of the bike. The black anodised covers with BMW Motorrad inscription and a diameter of 62 mm enhance the motorcycle visually and technically.



## OPTION 719 CLASSIC COVERS FOR EXPANSION TANKS



The Option 719 Classic covers for expansion tanks set an elegant, design highlight with their silver-coloured appearance. The milled cover made of anodised aluminium bears the inscription "Option 719". Together with the other special parts of Option 719 an exclusive customisation effect is created.

## OPTION 719 CLASSIC RIDER FOOTRESTS, ADJUSTABLE



The Classic aluminium rider footrests are adjustable in three positions and offer a high level of comfort in addition to ergonomic qualities. The high-quality milled parts of the exclusive Option 719 can be adapted to a sporty riding style or different rider statures and thus ensure even better control, for example in an inclined position.

## OPTION 719 CLASSIC ENGINE HOUSING COVER, FRONT



The Option 719 Classic engine housing cover sets an elegant, design highlight with its silver-coloured look. The high-quality milled cover made of anodised aluminium bears the Option 719 inscription. Together with the other special parts of Option 719 an exclusive customisation effect is created.

To be fitted and/or enabled in a specialist workshop, ideally at your authorised BMW Motorrad dealership.

## OPTION 719 CLASSIC FOOT LEVER, ADJUSTABLE



The exclusive Option 719 Classic milled aluminium foot levers are adjustable and emphasise the classic, high-quality character of the motorcycle. Adjusted to match, the foot levers can also be operated more sensitively when riding on large inclines. The high-quality milled parts with Option 719 branding add value to the bike.

## OPTION 719 CLASSIC HAND LEVER, ADJUSTABLE



The Classic hand levers of the exclusive Option 719 are milled from an anodised aluminium alloy. The grip width can be adjusted in five steps (brake lever) or three steps (clutch lever) using a setting screw and thus adapted to individual requirements. The high-quality Billet Pack parts with Option 719 branding add value to the bike.

To be fitted and/or enabled in a specialist workshop, ideally at your authorised BMW Motorrad dealership.

## OPTION 719 CLASSIC CYLINDER HEAD COVERS



The Classic cylinder head covers of the exclusive Option 719 add design highlights with their silver-coloured look. The high-quality milled covers made of anodised aluminium bring the boxer engine into the spotlight. The exclusive special parts bear the inscription "Option 719" and emphasise the high-quality character of the bike.

To be fitted and/or enabled in a specialist workshop, ideally at your authorised BMW Motorrad dealership.



OPTION 719 CLASSIC OIL FILLER PLUG



The safety screw for the oil filler neck is locked using a special Allen key, preventing theft of the cover. At the same time, unauthorised access and contamination of the oil by foreign substances is prevented. The high-quality aluminium lock has a BMW Boxer inscription.

LED INDICATORS



A shining example: The elegant LED flashing turn indicators with white turn indicator glass impress with their slim design and modern lighting technology. They respond much faster than incandescent lamps and are virtually wear-free. This provides a clear safety advantage in road traffic.

Please note the specifications for different countries. To be fitted and/or enabled in a specialist workshop, ideally at your authorised BMW Motorrad dealership.

CHROME-PLATED EXHAUST MANIFOLD

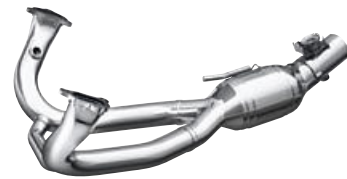

The chrome-plated exhaust manifold further enhances the motorcycle's appearance. This elegant manifold can be combined with the standard silencer or the HP sport silencer.



# ERGONOMICS & COMFORT

RIDER AND PASSENGER SEATS

The rider's seat in classic black has a seat height of 790mm and an inner leg curve of 1,780mm. 30mm lower than the standard version, this black rider's seat makes climbing on and off easier and keeps the ground within easy reach. The rider seat in black is 30mm higher and offers particularly tall riders noticeably better seating comfort. Thanks to a broader seat area and additional padding, the Comfort passenger seat provides noticeably greater seating comfort.

1 High rider seat, black



2 Low rider seat, black



3 Rider seat, black



4 Comfort passenger seat, black



5 Passenger seat, black



SPORT RIDER SEAT, BLACK

The Sport rider seat in black is higher and narrower than the standard seat and supports a sporty riding style thanks to its active seat position. With a seat height of 840mm and an inner leg curve of 1,875mm, it is particularly suitable for tall riders.





**CENTRE STAND**



The stable centre stand ensures a safe stand for the motorcycle even on slopes and offers advantages, for example, when refuelling, mounting cases and topcases or checking tyre pressure. The motorcycle also takes up less space when parked upright.

**TINTED WINDSCREEN**



The tinted windscreen emphasises the sporty character of the bike. The scratch-resistant coating ensures long-term unimpeded visibility. Same design and size as the standard windscreen.

**ENDURO FOOTREST**



The Enduro footrest has a wider and longer tread area and therefore offers more support and non-slip footing. This enables better vehicle control when riding off-road in a standing position without restricting the operability of the gear lever.

To be fitted and/or enabled in a specialist workshop, ideally at your authorised BMW Motorrad dealership.

**PRO GEAR-SHIFT ASSIST**

The shift assistant Pro allows shifting up and down in almost all load ranges and engine speed ranges without actuating the clutch or throttle. The assistant thus ensures noticeably reduced shifting times, a relief of the clutch hand and thus greater comfort and dynamics.



**RETROFIT SET FOR HEATED GRIPS FOR VEHICLES WITH / WITHOUT CRUISE CONTROL (NOT SHOWN)**

No more cold hands: This is ensured by the electric heating grips with multi-stage control. This increases comfort and provides more safety, because with warm hands and more feeling in the fingers, the vehicle can simply be controlled better. The heated grip is conveniently operated via a combination switch on the handlebars.

To be fitted and/or enabled in a specialist workshop, ideally at your authorised BMW Motorrad dealership.

**PRO RIDING MODES RETROFIT SET (NOT SHOWN)**

The Pro riding modes can be retrofitted using an enabling code. Riders of older motorcycles therefore do not have to do without modern safety features. Depending on the year of manufacture, retrofitting is possible with the Pro, Pro with DTC or Pro with ABS Pro, DTC and HSC modes.

To be fitted and/or enabled in a specialist workshop, ideally at your authorised BMW Motorrad dealership.

**CRUISE CONTROL RETROFIT SET (NOT SHOWN)**

The electronic cruise control can be activated from 30 km/h and keeps the riding speed constant. This makes it possible to enjoy longer motorway stretches in a relaxed style. The function is deactivated on braking, and the selected speed is automatically adopted after activating the resume button.

To be fitted and/or enabled in a specialist workshop, ideally at your authorised BMW Motorrad dealership.

**HILL START CONTROL RETROFIT SET (NOT SHOWN)**

Park or pull away on up or down gradients, even with a passenger and heaps of luggage on board. Also available as optional equipment.

To be fitted and/or enabled in a specialist workshop, ideally at your authorised BMW Motorrad dealership. For more detailed information, contact your authorised BMW Motorrad dealership or go online at [bmw-motorrad.com](http://bmw-motorrad.com)

# NAVIGATION & COMMUNICATION

**BMW MOTORRAD NAVIGATOR VI**

With the multifunctional Navigator VI, route planning becomes child's play. The system with 16 GB flash memory and a five-inch touch screen always shows the right way. Thanks to the circular polarisation filter (CPOL), the waterproof display is easy to read even in direct sunlight. The high-resolution screen in a casing similar to a smartphone provides all the essential information and ensures that you can see the big picture required in every situation. Numerous additional functions make planning and touring an exciting experience. Plan your routes can be created according to your personal preferences and enjoy driving on winding and quiet side roads. In unknown terrain, the "round trip" option is a good choice as it reliably guides the rider at the end of the tour back to the starting

point. The Bluetooth connection to the BMW Motorrad communication system and the optional Smartphone Link app enable multimedia on the go: navigation announcements, telephone calls and music streaming as well as the retrieval of weather forecasts or traffic jam information are no problem. Navigation preparation adds further functions such as "My Motorcycle", and the multi-controller on the handlebars offers an alternative control option. Choose the pre-installed map data, and you will always be up to date thanks to lifelong, free map updates.

Note the differences in national-market versions. Only available in conjunction with OE navigation preparation.

**1 BMW Motorrad Navigator VI**



**2 Navigation preparation retrofit set (not shown)**



## SAFETY

## LED AUXILIARY HEADLIGHTS



The powerful LED auxiliary headlights ensure the required vision in poor visibility conditions.

To be fitted and/or enabled in a specialist workshop, ideally at your authorised BMW Motorrad dealership. The auxiliary headlights are approved for use as fog lights, and may only be used in poor weather conditions. Country-specific road traffic regulations apply.

## ENGINE PROTECTION BAR



The robust engine protection bar, made of polished stainless steel, reliably protects the cylinder area against damage without restricting the rider's freedom to lean the machine. The robust tube construction will even take hard knocks and prevent major fall damage on asphalt.

## CYLINDER HEAD COVER GUARD



The stainless steel cylinder-head cover guard provides excellent protection for the cylinder head cover, preventing scratches and damage caused by flying stones. It has been perfectly matched to the vehicle, is equipped with a large rubber bumper and optimally emphasises the design and contours of the boxer engine.

## SAFETY SCREW FOR OIL FILLER CAP



The safety screw for the oil filler neck is locked using a special Allen key, preventing theft of the cover. At the same time, unauthorised access and contamination of the oil by foreign substances is prevented. The high-quality aluminium lock has a BMW Boxer inscription.

## PROTECTIVE GLASS FOR 6.5-INCH TFT DISPLAY



The protective glass reliably protects the 6.5-inch TFT display from dirt, flying stones and damage. The tempered glass has an anti-glare and anti-reflective surface, so that it is still easy to read the TFT display in off-road use. With BMW Motorrad inscription.

## DAYTIME RUNNING LIGHT RETROFIT SET (NOT SHOWN)

## ABS PRO RETROFIT SET (NOT SHOWN)

To be fitted and/or enabled in a specialist workshop, ideally at your authorised BMW Motorrad dealership.

## RETROFIT SET FOR ANTI-THEFT ALARM (NOT SHOWN)

NEW

Strong protection from theft: If the motorcycle is moved or struck violently, the anti-theft alarm system responds with a clearly audible signal and a flashing warning light. The acoustic and optical warning will draw the attention of passers-by quickly. The alarm system is activated automatically when the ignition is switched off.

Note the differences in national-market versions. To be fitted and/or enabled in a specialist workshop, ideally at your authorised BMW Motorrad dealership.

## TYRE PRESSURE CONTROL RETROFIT SET (NOT SHOWN)

Tyre Pressure Control (TPC) with all functions can be retrofitted by installing the control unit. TPC provides reliable information about the current tyre pressure and warns the rider about pressure loss at an early stage. The corresponding notifications and instructions are provided by the on-board computer in the cockpit.

To be fitted and/or enabled in a specialist workshop, ideally at your authorised BMW Motorrad dealership.

## MAINTENANCE &amp; TECHNOLOGY

## POWER SOCKET

Electronic devices can be connected to the vehicle electrical system via the 12V power socket. One example of this is the BMW USB charger, which can be used to charge and operate mobile phones and MP3 players with an appropriate interface while riding.

To be fitted and/or enabled in a specialist workshop, ideally at your authorised BMW Motorrad dealership.



Original BMW Motorrad equipment is available from your authorised BMW Motorrad dealership.



# URBAN MOBILITY

C 400 X	60	C 650 SPORT	80
C 400 GT	66	C EVOLUTION	88
C 650 GT	72		
Model codes 0C05, 0C15			

**WAKE UP TO LIFE EVERY  
MORNING WITH YOUR  
ENGINE RUNNING.**  
BE IMPATIENT TO GET  
OUT AND GET ON IT.





# ACCESSORIES FOR BMW C 400 X



## STORAGE

### SMALL TOPCASE, 30L

This waterproof plastic topcase with the BMW badge offers enough space for a helmet with its volume of 30 litres. The lid, which is available in Granite Grey Matt Metallic and Racing Red, and the soft-close hinges, which allow the lid to be lowered gently, underline the high-quality impression.

Only available in conjunction with luggage grid and topcase rack. For information on speed and load restrictions, please refer to the instruction booklet. For more detailed information, contact your authorised BMW Motorrad dealership or go online at [bmw-motorrad.com](http://bmw-motorrad.com).

1 Small topcase, 30l, Granite grey metallic matt



2 Small topcase, 30l, Racing red



### BACKREST PAD FOR SMALL TOPCASE



Thanks to the comfortable backrest pad for the small topcase, the passenger can enjoy improved comfort both on short trips and on long tours.

### LIGHT TOPCASE, 29L



With a volume of 29 litres, the light topcase offers enough space for a helmet and convinces in everyday life as well as on short tours. The black plastic topcase is lockable, has a large reflector on the rear side and a BMW badge on the lid. The maximum load is 3 kg.

Only available in conjunction with luggage grid. For information on speed and load restrictions, please refer to the instruction booklet.

### LINER FOR LIGHT TOPCASE (29L) AND TOPCASE (30L)



The matching tailored liner for the topcase gets the luggage organised and facilitates loading and unloading. The carry handle and shoulder strap make the bag easy to access and transport. The practical details include the outside pocket and the three-sided zipper.

### LUGGAGE CARRIER



The sturdy, stylish luggage grid is ideal for reliably securing the topcase or other large items of luggage. In addition, it serves as a convenient handle for the passenger and is also ideal for using as a pushing aid when manoeuvring.





## ERGONOMICS &amp; COMFORT

## HIGH WINDSCREEN



The scratch-resistant BMW Motorrad high windscreen is higher than the standard windscreen and offers maximum wind and weather protection for rider and passenger. Its aerodynamically optimised shape reduces air turbulence and riding noise to a minimum, even at high speeds. Optimum wind protection for long journeys.

## LOW SEAT



Thanks to its low height of just 760 mm, mounting the motorcycle with the low seat is rendered child's play. And even after an entire day on the road, it is still easy to dismount the bike thanks to the low seat. The improved ground accessibility ensures additional riding comfort.

**Low seat**

Seat height: 760 mm; step length: 1,730 mm

## SCOOTER CANOPY

Always stay nice and clean. And dry. The waterproof BMW Motorrad Scooter leg cover reliably protects the legs and lower body from water, wind and dirt while riding. Thanks to the patented anti-flutter system, the protective hood also closely fits the Scooter and leg at high speeds. Thus it is fun accelerating even when it rains.

HEATED GRIPS AND SWITCHES  
(NOT SHOWN)

Keep your hands warm with heated grips that come with two settings.

For more detailed information, contact your authorised BMW Motorrad dealership or go online at [bmw-motorrad.com](http://bmw-motorrad.com). To be fitted and/or enabled in a specialist workshop, ideally at your authorised BMW Motorrad dealership.

## NAVIGATION &amp; COMMUNICATION

## BMW MOTORRAD NAVIGATOR VI

With the multifunctional Navigator VI, route planning becomes child's play. The system with 16 GB flash memory and a five-inch touch screen always shows the right way, and the waterproof display is easy to read even in direct sunlight. The high-resolution screen provides all the essential information and ensures that you can see the big picture required in every situation. Numerous additional functions make planning and touring an exciting experience. Plan your routes can be created according to your personal preferences and enjoy driving on winding and quiet side roads. In unknown terrain, the "round trip" option is a good choice as it reliably guides the rider at the end of the tour back to the starting point. The Bluetooth connection to the BMW Motorrad communication system and the optional Smartphone Link app enable multimedia on the go: navigation announcements, telephone calls and music streaming as well as the retrieval of weather forecasts or traffic jam information are no problem. Operation is via the stable Mount Cradle; the four buttons can also be accurately controlled while wearing gloves. Choose the pre-installed map data, and you will always be up to date thanks to lifelong, free map updates.



Please note the specifications for different countries. Only available in conjunction with OE navigation preparation or for vehicles without navigation preparation only with 4-button Mount Cradle and holder.

## BMW MOTORRAD SMARTPHONE CRADLE

BMW Motorrad's robust smartphone cradle provides a safe and protected place for your smartphone. This means that useful functions such as navigation information and online information can also be used while you are on the move. Thanks to the handy charging function, your smartphone is also always ready for action on extended bike tours.

Only in combination with bracket for BMW Motorrad navigation devices.



## BRACKET FOR BMW MOTORRAD NAVIGATION DEVICES

The functional bracket for the navigation systems and the smartphone cradle from BMW Motorrad is securely attached to the handlebar clamp. This ensures that it can be positioned in the rider's direct field of vision. In addition, the bracket complements perfectly the cockpit area.





## SAFETY

### LED AUXILIARY HEADLIGHTS



The powerful LED additional headlights extend the illumination to ensure the required vision in poor visibility conditions. Thus they perfectly complement the main headlight. LED technology ensures virtually wear-free operation.

To be fitted and/or enabled in a specialist workshop, ideally at your authorised BMW Motorrad dealership. The additional headlights are approved for use as fog lights, and may only be used in poor weather conditions. Country-specific road traffic regulations apply. Only available in conjunction with front fairing protection bar.

### FRONT FAIRING PROTECTION BAR



The high-quality BMW Motorrad fairing protection bar effectively prevents paintwork damage during daily riding without compromising the lean angle. It is made of sturdy stainless steel, electropolished for corrosion protection, and weighs just 3.4 kg. The Scooter is therefore well protected and looks even more robust.

To be fitted and/or enabled in a specialist workshop, ideally at your authorised BMW Motorrad dealership.

### ANTI-THEFT ALARM RETROFIT SET (NOT SHOWN)

Strong protection from theft: If the motorcycle is moved or struck violently, the anti-theft alarm system responds with a clearly audible signal and a flashing warning light. The acoustic and optical warning will draw the attention of passers-by quickly. The alarm system is activated automatically when the ignition is switched off.

Note the differences in national-market versions. To be fitted and/or enabled in a specialist workshop, ideally at your authorised BMW Motorrad dealership.

### PROTECTIVE GLASS FOR 6.5-INCH TFT DISPLAY NEW

The protective glass reliably protects the 6.5-inch TFT display from dirt, flying stones and damage. The tempered glass has an anti-glare and anti-reflective surface, so that it is still easy to read the TFT display. With BMW Motorrad inscription.



## MAINTENANCE & TECHNOLOGY

### VEHICLE COVER

Snug and waterproof yet breathable, this cover protects your maxi-scooter from rain, dirt and more. Made of tear-resistant, UV-resistant material.



Original BMW Motorrad equipment is available from your authorised BMW Motorrad dealership.



# ACCESSORIES FOR BMW C 400 GT



## STORAGE

### SMALL TOPCASE, 30 L

This waterproof plastic topcase with the BMW badge offers enough space for a helmet with its volume of 30 litres. The lid, which is available in Granite grey metallic matt and Racing red, and the soft-close hinges, which allow the lid to be lowered gently, underline the high-quality impression.

Only available in conjunction with the luggage grid and topcase rack. For information on speed and load restrictions, please refer to the instruction booklet. For more detailed information, contact your authorised BMW Motorrad dealership or go online at [bmw-motorrad.com](http://bmw-motorrad.com).

1 Small topcase, 30l, Granite grey metallic matt



2 Small topcase, 30l, Racing red



### BACKREST PAD FOR SMALL TOPCASE



Thanks to the comfortable backrest pad for the small topcase, the passenger can enjoy improved comfort both on short trips and on long tours.

### LIGHT TOPCASE, 29 L



With a volume of 29 litres, the light topcase offers enough space for a helmet and convinces in everyday life as well as on short tours. The black plastic topcase is lockable, has a large reflector on the rear side and a BMW badge on the lid. The maximum load is 3 kg.

Only available in conjunction with luggage grid. For information on speed and load restrictions, please refer to the instruction booklet.

### LINER FOR LIGHT TOPCASE (29 L) AND TOPCASE (30 L)



The matching tailored liner for the topcase gets the luggage organised and facilitates loading and unloading. The carry handle and shoulder strap make the bag easy to access and transport. The practical details include the outside pocket and the three-sided zipper.

### LUGGAGE CARRIER



The sturdy, stylish luggage grid is ideal for reliably securing the topcase or other large items of luggage. In addition, it serves as a convenient handle for the passenger and is also ideal for using as a pushing aid when manoeuvring.

For more detailed information, contact your authorised BMW Motorrad dealership or go online at [bmw-motorrad.com](http://bmw-motorrad.com). To be fitted and/or enabled in a specialist workshop, ideally at your authorised BMW Motorrad dealership.

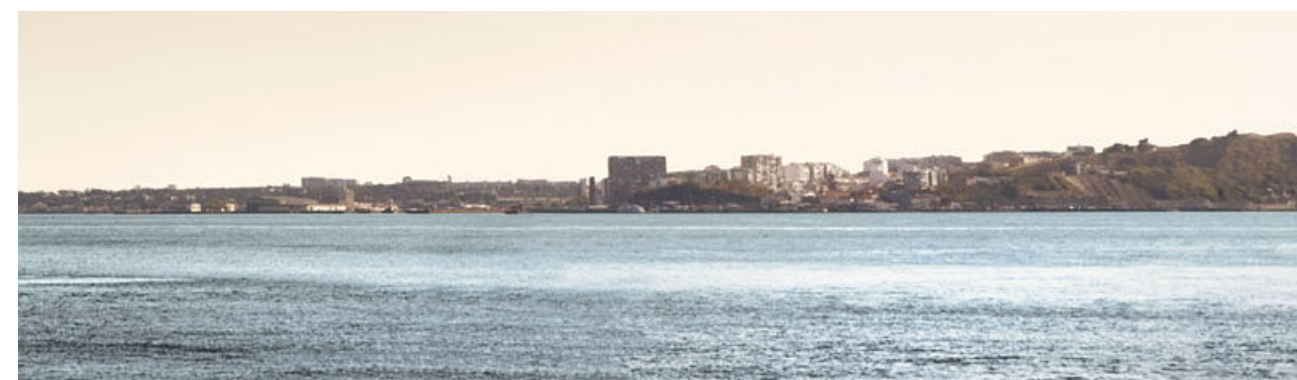

Original BMW Motorrad equipment is available from your authorised BMW Motorrad dealership.



## ERGONOMICS & COMFORT

### HIGH WINDSCREEN



The scratch-resistant BMW Motorrad high windscreen is higher than the standard windscreen and offers maximum wind and weather protection for rider and passenger. Its aerodynamically optimised shape reduces air turbulence and riding noise to a minimum, even at high speeds. Optimum wind protection for long journeys.

### LOW SEAT

NEW



15 mm lower than the standard version, this low seat makes climbing on off easier and keeps the ground within easy reach. Many riders feel safer thanks to the reduced seat height, because they can manoeuvre and control their motorcycle more easily. The high-quality surface material in black corresponds to the standard equipment.

#### Low seat

Seat height: 760 mm; step length: 1,730 mm

### SCOOTER CANOPY



Always stay nice and clean. And dry. The waterproof BMW Motorrad Scooter leg cover reliably protects the legs and lower body from water, wind and dirt while riding. Thanks to the patented anti-flutter system, the protective hood also closely fits the Scooter and leg at high speeds. Thus it is fun accelerating even when it rains.



### HEATED GRIPS AND SWITCHES (NOT SHOWN)

Keep your hands warm with heated grips that come with two settings.

For more detailed information, contact your authorised BMW Motorrad dealership or go online at [bmw-motorrad.com](http://bmw-motorrad.com). To be fitted and/or enabled in a specialist workshop, ideally at your authorised BMW Motorrad dealership.

## NAVIGATION & COMMUNICATION

### BMW MOTORRAD NAVIGATOR VI

With the multifunctional Navigator VI, route planning becomes child's play. The system with 16 GB flash memory and a five-inch touch screen always shows the right way, and the waterproof display is easy to read even in direct sunlight. The high-resolution screen provides all the essential information and ensures that you can see the big picture required in every situation. Numerous additional functions make planning and touring an exciting experience. Plan your routes can be created according to your personal preferences and enjoy driving on winding and quiet side roads. In unknown terrain, the "round trip" option is a good choice as it reliably guides the rider at the end of the tour back to the starting point. The Bluetooth connection to the BMW Motorrad communication system and the optional Smartphone Link app enable multimedia on the go: navigation announcements, telephone calls and music streaming as well as the retrieval of weather forecasts or traffic jam information are no problem. Operation is via the stable Mount Cradle; the four buttons can also be accurately controlled while wearing gloves. Choose the pre-installed map data, and you will always be up to date thanks to lifelong, free map updates.



BMW Motorrad navigation devices and the BMW Motorrad smartphone cradle can only be mounted using the BMW Motorrad navigation device bracket. For more detailed information, contact your authorised BMW Motorrad dealership or go online at [bmw-motorrad.com](http://bmw-motorrad.com). Only in combination with bracket for navigation systems. Note the differences in national-market versions.

### BMW MOTORRAD SMARTPHONE CRADLE



BMW Motorrad's robust smartphone cradle provides a safe and protected place for your smartphone. This means that useful functions such as navigation information and online information can also be used while you are on the move. Thanks to the handy charging function, your smartphone is also always ready for action on extended bike tours.

Only in combination with bracket for BMW Motorrad navigation devices.

### BRACKET FOR BMW MOTORRAD NAVIGATION DEVICES



The functional bracket for the navigation systems and the smartphone cradle from BMW Motorrad is securely attached to the handlebar clamp. This ensures that it can be positioned in the rider's direct field of vision. In addition, the bracket complements perfectly the cockpit area.

Original BMW Motorrad equipment is available from your authorised BMW Motorrad dealership.



## SAFETY

### ANTI-THEFT ALARM RETROFIT SET (NOT SHOWN)

Strong protection from theft: If the motorcycle is moved or struck violently, the anti-theft alarm system responds with a clearly audible signal and a flashing warning light. The acoustic and optical warning will draw the attention of passers-by quickly. The alarm system is activated automatically when the ignition is switched off.

Note the differences in national-market versions.  
To be fitted and/or enabled in a specialist workshop,  
ideally at your authorised BMW Motorrad dealership.

### PROTECTIVE GLASS FOR 6.5-INCH TFT DISPLAY NEW

The protective glass reliably protects the 6.5-inch TFT display from dirt, flying stones and damage. The tempered glass has an anti-glare and anti-reflective surface, so that it is still easy to read the TFT display. With BMW Motorrad inscription.



## MAINTENANCE & TECHNOLOGY

### COVER



Snug and waterproof yet breathable, this cover protects your maxi-scooter from rain, dirt and more. Made of tear-resistant, UV-resistant material.





# ACCESSORIES FOR BMW C 650 GT



## STORAGE

### TOPCASE, 35 L



The waterproof topcase is available with lid trims in the same colour as the Maxi-Scooter itself. The optional backrest pad offers additional comfort for the passenger.

Available in colours: Black storm metallic, Frozen bronze metallic and Light white.

Only available in conjunction with the luggage grid. Not available in combination with backrest for passenger. For information on speed and load limitations, please refer to the instruction booklet.

### LUGGAGE CARRIER



The sturdy, stylish luggage grid is ideal for securing the topcase or other large items of luggage. With padding and artificial leather in black, the backrest for the passenger can be used in conjunction with the luggage grid (without topcase).

To be fitted and/or enabled in a specialist workshop, ideally at your authorised BMW Motorrad dealership.

### BACKREST PAD FOR TOPCASE, 35 L



The comfortable backrest pad for the 35l topcase offers the passenger more comfort both on short trips and on long tours.

### PARTITION NET FOR LUGGAGE COMPARTMENT



Divides the storage compartment below the seat into two sections when required, e.g. for transporting small items. It can be installed and removed quickly, and is easy to tuck away when not in use.

To be fitted and/or enabled in a specialist workshop, ideally at your authorised BMW Motorrad dealership.

### CENTRE TUNNEL BAG



Fits the Maxi-Scooter perfectly, and offers a 12l capacity, waterproof main compartment. It has a detachable shoulder strap and a top pocket for small items. Can be attached and removed quickly and easily.

Original BMW Motorrad equipment is available from your authorised BMW Motorrad dealership.





# DESIGN

## CHROME PARTS

The chrome-plated footrest inserts and handlebar weights add a classy, personal touch to the scooter.

Use of handlebar weight is restricted when the Scooter lock is fitted (Scooter lock fastener takes the place of the left handlebar weight).

To be fitted and/or enabled in a specialist workshop, ideally at your authorised BMW Motorrad dealership.

### 1 Chrome-plated footrest insert



### 2 Chrome-plated footrest insert, rear



### 3 Chrome-plated handlebar weight



# ERGONOMICS & COMFORT

## HEATED SEAT AND HEATED GRIPS



For a comfortable ride even in cooler weather: there are separate controls for the seat heating for both the driver and passenger.

To be fitted and/or enabled in a specialist workshop, ideally at your authorised BMW Motorrad dealership.

## LOW SEAT



15 mm lower than the standard version, this low seat makes climbing on off easier and keeps the ground within easy reach.

### Low seat

Seat height: 785 mm,  
step length: 1,855 mm

## EXCLUSIVE SEAT



The two-tone colour scheme in black/grey, textured surface and decorative stitching in Quartz grey make the heated Exclusive seat a real highlight.

### Exclusive seat

Seat height: 805 mm,  
step length: 1,910 mm

To be fitted and/or enabled in a specialist workshop, ideally at your authorised BMW Motorrad dealership. Seat heating function retrofittable on vehicles that do not have order number 518 "seat heating"; new multifunction switch and adapter cable required.

## SCOOTER CANOPY



Always stay nice and clean. And dry. The waterproof BMW Motorrad Scooter leg cover reliably protects the legs and lower body from water, wind and dirt while riding. Thanks to the patented anti-flutter system, the protective hood also closely fits the Scooter and leg at high speeds. Thus it is fun accelerating even when it rains.

Recommended maximum speed 130 km/h.  
To be fitted and/or enabled in a specialist workshop, ideally at your authorised BMW Motorrad dealership.

## WIND DEFLECTORS



The black wind deflectors are firmly attached to the trim panel and effectively protect the hands from wind and weather.



**COVER**

Snug and waterproof yet breathable, this cover protects your maxi-scooter from rain, dirt and more. Made of tear-resistant, UV-resistant material.

**BACKREST FOR PASSENGER**

With padding and artificial leather in black, the backrest delivers greater comfort for the passenger, and can be used in conjunction with the luggage grid (without topcase).

To be fitted and/or enabled in a specialist workshop, ideally at your authorised BMW Motorrad dealership. It is not possible to combine the topcase and the passenger back rest.



# NAVIGATION & COMMUNICATION

**BMW MOTORRAD NAVIGATION SYSTEMS**

The multifunctional BMW Motorrad Navigator VI without pre-installed maps makes route planning child's play. The system with 4 GB flash memory and five-inch touch screen always gives the right directions, and the waterproof display is easy to read even in direct sunlight owing to the circular polarisation filter. The high-resolution screen provides all the essential information and ensures that you can see the big picture required in every situation. Numerous additional functions make planning and touring an exciting experience. Plan your routes can be created according to your personal preferences and enjoy driving on winding and quiet side roads. The rider can also preset route guidance to avoid certain roads, e.g. A-roads. In unknown terrain, the "round trip" option is a good choice as it reliably guides the rider at the end of the tour back to the starting point. The Bluetooth connection to the BMW Motorrad communication system and the optional

Smartphone Link app enable multimedia on the go: navigation announcements, telephone calls and music streaming as well as the retrieval of weather forecasts or traffic jam information are no problem. Navigation preparation adds further functions such as "My Motorcycle", and the multi-controller on the handlebars offers an alternative control option. The desired map material can simply be installed on the Navigator using an SD card.

BMW Motorrad navigation devices and the BMW Motorrad smartphone cradle can only be mounted using the BMW Motorrad navigation device bracket. For more detailed information, contact your authorised BMW Motorrad dealership or go online at [bmw-motorrad.com](http://bmw-motorrad.com).

**1 BMW Motorrad Navigator VI****2 Bracket for BMW Motorrad navigation devices****BMW MOTORRAD SMARTPHONE CRADLE**

BMW Motorrad's robust smartphone cradle provides a safe and protected place for your smartphone. This means that useful functions such as navigation information and online information can also be used while you are on the move. Thanks to the handy charging function, your smartphone is also always ready for action on extended bike tours.

Only in combination with bracket for BMW Motorrad navigation devices.





# SAFETY

## SCOOTER LOCK



The Scooter lock is a quick and effective solution for theft protection. With the sheathed chain made of ultra-hard steel, the handlebar end of the Maxi-Scooter can be fixed to the swinging arm or a fixed object in no time at all. When not in use, the lock can be stowed under the seat in the storage bag provided.

Can be combined with chrome-plated handlebar weight, with restrictions (Scooter lock fastener takes the place of the left handlebar weight). To be fitted and/or enabled in a specialist workshop, ideally at your authorised BMW Motorrad dealership.

## CRASH PADS



The drop-protection pads made of robust plastic protect the Scooter from damage in the case of a fall. The abrasion-resistant pads are screwed to the trim panel at the front and the footboards at the rear, and offer effective protection if the bike should fall over or in the event of a fall at low speed.

For more detailed information, contact your authorised BMW Motorrad dealership or go online at [bmw-motorrad.com](http://bmw-motorrad.com). To be fitted and/or enabled in a specialist workshop, ideally at your authorised BMW Motorrad dealership. Model shown: BMW C 650 GT, 2015.

## ASPHERICAL MIRROR



The aspherical mirror glass with its curved surface enlarges the field of view and almost completely eliminates the blind spot.

To be fitted and/or enabled in a specialist workshop, ideally at your authorised BMW Motorrad dealership.

## ANTI-THEFT ALARM SYSTEM (NOT SHOWN)

Strong protection from theft: If the motorcycle is moved or struck violently, the anti-theft alarm system responds with a clearly audible signal and a flashing warning light. The acoustic and optical warning will draw the attention of passers-by quickly. The alarm system is activated automatically when the ignition is switched off.

To be fitted and/or enabled in a specialist workshop, ideally at your authorised BMW Motorrad dealership. Also available as an equipment option.

## TYRE PRESSURE CONTROL RETROFIT SET (NOT SHOWN)

Tyre Pressure Control (TPC) with all functions can be retrofitted by installing the control unit. TPC provides reliable information about the current tyre pressure and warns the rider about pressure loss at an early stage. The corresponding notifications and instructions are provided by the on-board computer in the cockpit.

To be fitted and/or enabled in a specialist workshop, ideally at your authorised BMW Motorrad dealership.





# ACCESSORIES FOR BMW C 650 SPORT



## STORAGE

### TOPCASE, 35 L

This topcase is mounted on the luggage carrier and offers enough space for a helmet with its volume of 35 litres. The waterproof luggage box is available with lid trims in the same body colour as the Maxi-Scooter itself. The reflector on the lid is standard, the liner, backrest pad and vehicle lock are among the handy options.

To be fitted and/or enabled in a specialist workshop, ideally at your authorised BMW Motorrad dealership.

**1 Topcase, 35 l with topcase lid trim, Blackstrom metallic**



**2 Topcase lid trim, Austin yellow metallic**



**3 Topcase lid trim, Light white**



**4 Topcase lid trim, Valencia orange metallic matt**



### BACKREST PAD FOR TOPCASE, 35 L



The comfortable backrest pad for the 35 l topcase offers the passenger more comfort both on short trips and on long tours.

### LUGGAGE GRID



The sturdy, stylish luggage carrier is ideal for reliably securing the topcase or other large items of luggage. An optional backrest can also be fitted to provide additional comfort for the passenger.

To be fitted and/or enabled in a specialist workshop, ideally at your authorised BMW Motorrad dealership.

### PARTITION NET FOR LUGGAGE COMPARTMENT



Divides the storage compartment below the seat into two sections when required, e.g. for transporting small items. It can be installed and removed quickly, and is easy to tuck away when not in use.

### CENTRE TUNNEL BAG



The practical centre-tunnel bag with waterproof main compartment provides 12 litres of storage space and can be attached to the scooter quickly and easily.

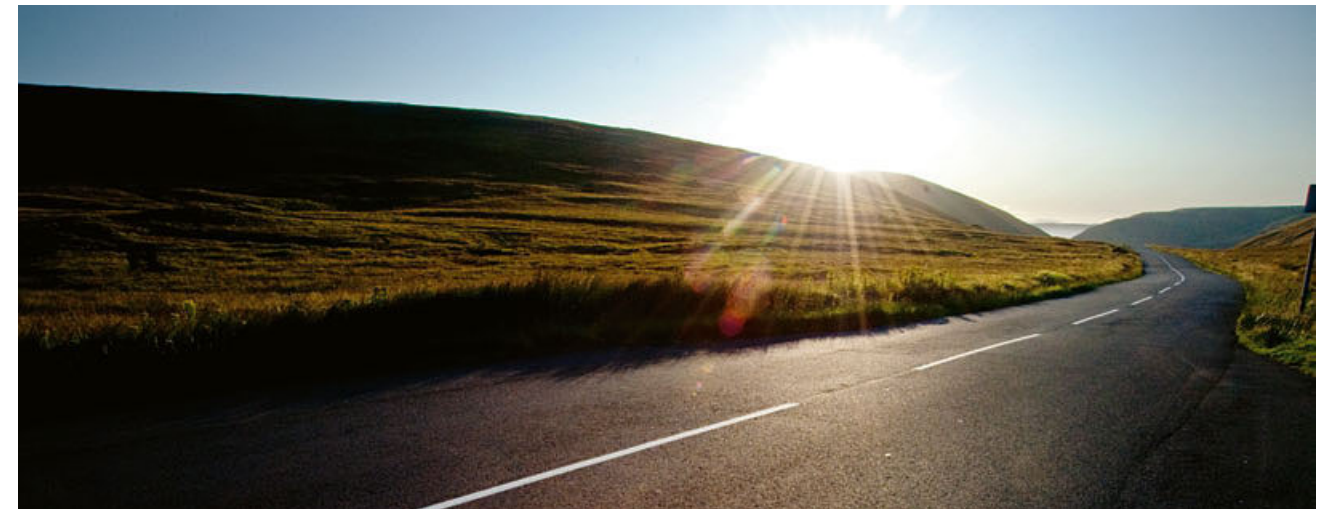

Original BMW Motorrad equipment is available from your authorised BMW Motorrad dealership.



# DESIGN

## CHROME PARTS

The chrome-plated footrest inserts and handlebar weights add a classy, personal touch to the scooter.

The chrome-plated rear footrests, footrest inserts and handlebar weights add a sophisticated styling accent and underline the individual look of the Maxi-Scooter.

### Chrome-plated rear footrest (not shown)

To be fitted and/or enabled in a specialist workshop, ideally at your authorised BMW Motorrad dealership.

### 1 Chrome-plated footrest insert



### 2 Chrome-plated handlebar weight



# ERGONOMICS & COMFORT

## HEATED SEAT AND HEATED GRIPS

There are separate controls for the seat heating for both the driver and passenger to ensure a comfortable ride even in cooler weather.

### Heated seat (not shown)

Seat height: 800 mm,  
step length: 1,855 mm

To be fitted and/or enabled in a specialist workshop, ideally at your authorised BMW Motorrad dealership.



## BACKREST FOR PASSENGER

With the padded backrest the passenger enjoys more comfort on short trips as well as on longer tours.

To be fitted and/or enabled in a specialist workshop, ideally at your authorised BMW Motorrad dealership. It is not possible to combine the topcase and the passenger back rest.



## LOW SEAT



20 mm lower than the standard version, this low rider seat makes climbing on and handling easier. Not compatible with seat heating retrofit.

### Low seat

Seat height: 780 mm,  
step length: 1,810 mm

## SPORT SEAT



The two-tone colour scheme in black/grey, textured surface and decorative double stitching in blue make the high-quality heated Sport seat a real highlight.

### Sport seat

Seat height: 800 mm,  
step length: 1,855 mm

To be fitted and/or enabled in a specialist workshop, ideally at your authorised BMW Motorrad dealership. Seat heating function retrofittable on vehicles that do not have option code 518 "seat heating"; new multifunction switch and adapter cable required.



**TINTED WINDSCREEN**

The tinted windscreen gives the Maxi-Scooter a personal touch. The special coating also permanently prevents scratches. The dimensions and shape are identical to the standard windscreen.

To be fitted and/or enabled in a specialist workshop, ideally at your authorised BMW Motorrad dealership.



**SPORT WINDSCREEN, TINTED**

The tinted Sport windscreen gives the maxi-scooter a personal touch and sporty nuance. The special coating also permanently prevents scratches.

To be fitted and/or enabled in a specialist workshop, ideally at your authorised BMW Motorrad dealership.



**SPORT WINDSCREEN (NOT SHOWN)**

The sport windscreen in clear-glass look has a scratch-resistant coating on both sides. It offers perceptible wind protection for the rider and a sporty look.

To be fitted and/or enabled in a specialist workshop, ideally at your authorised BMW Motorrad dealership.

**SCOOTER LEG COVER**



This waterproof protective cover is quick to attach and secure, keeping your favourite trousers safe from spray and also offering extra insulation against the cold when needed. Can be protected from unauthorized removal with the optional scooter lock.

To be fitted and/or enabled in a specialist workshop, ideally at your authorised BMW Motorrad dealership.

**RAIN COVER FOR SEAT**



The snug-fitting rain cover for the seat is waterproof and is fastened using an elastic drawstring under the seat. The hood made of PU-coated nylon is tear-resistant and UV-resistant, making it ideal for all weathers. When not in use, it can be folded down to a compact size and stowed in the practical storage bag.

# NAVIGATION & COMMUNICATION

**BMW MOTORRAD NAVIGATION SYSTEMS**

The BMW Motorrad Navigator VI without pre-installed maps makes route planning child's play, and provides a range of additional functions which turn every tour into a real adventure. The five-inch touch screen is waterproof, easy to read even in direct sunlight, and guarantees the necessary overview at all times.

The BMW Motorrad navigation systems holder is mounted on the handlebar clamping block in the rider's direct field of view.

BMW Motorrad navigation devices and the BMW Motorrad smartphone cradle can only be mounted using the BMW Motorrad navigation device bracket. For more detailed information, contact your authorised BMW Motorrad dealership or go online at [bmw-motorrad.com](http://bmw-motorrad.com).

**1 BMW Motorrad Navigator VI**



**2 Bracket for BMW Motorrad navigation devices**



**BMW MOTORRAD SMARTPHONE CRADLE**



BMW Motorrad's robust smartphone cradle provides a safe and protected place for your smartphone. This means that useful functions such as navigation information and online information can also be used while you are on the move. Thanks to the handy charging function, your smartphone is also always ready for action on extended bike tours.

Only in combination with bracket for BMW Motorrad navigation devices.

**MOBILE PHONE ADAPTER FOR STORAGE COMPARTMENT**



The custom-fit insert for the storage compartment offers space for a mobile phone and other small items. If the BMW USB charger is available on board, the smartphone can be charged while riding. The handy insert has a number of compartments. It can be locked, is waterproof and ensures that items are safely stowed.



## SAFETY

### SCOOTER LOCK



This scooter lock is a quick and effective solution for theft protection. With the sheathed chain made of ultra-hard steel, the handlebar end of the Maxi-Scooter can be fixed to the swinging arm or a fixed object in no time at all. When not in use, the lock can be stowed under the seat in the storage bag provided.

To be fitted and/or enabled in a specialist workshop, ideally at your authorised BMW Motorrad dealership.  
Use of the chrome-plated handlebar weight is restricted when the Scooter lock is fitted (Scooter lock fastener takes the place of the left handlebar weight).  
Model shown: BMW C 650 GT, 2015.

### ANTI-THEFT ALARM SYSTEM (NOT SHOWN)

Strong protection from theft: If the motorcycle is moved or struck violently, the anti-theft alarm system responds with a clearly audible signal and a flashing warning light. The acoustic and optical warning will draw the attention of passers-by quickly. The alarm system is activated automatically when the ignition is switched off.

To be fitted and/or enabled in a specialist workshop, ideally at your authorised BMW Motorrad dealership.

### LED INDICATORS



A shining example: The beautifully designed LED indicators with white turn indicator glass convince with their slim design and modern lighting technology. They respond much faster than incandescent lamps and are virtually wear-free. This provides a clear safety advantage in road traffic.

To be fitted and/or enabled in a specialist workshop, ideally at your authorised BMW Motorrad dealership.

### TYRE PRESSURE CONTROL RETROFIT SET (NOT SHOWN)

NEW

Tyre Pressure Control (TPC) with all functions can be retrofitted by installing the control unit. TPC provides reliable information about the current tyre pressure and warns the rider about pressure loss at an early stage. The corresponding notifications and instructions are provided by the on-board computer in the cockpit.

To be fitted and/or enabled in a specialist workshop, ideally at your authorised BMW Motorrad dealership.

## MAINTENANCE & TECHNOLOGY

### COVER

Snug and waterproof yet breathable, this cover protects your maxi-scooter from rain, dirt and more. Made of tear-resistant, UV-resistant material.



Original BMW Motorrad equipment is available from your authorised BMW Motorrad dealership.



# ACCESSORIES FOR BMW C EVOLUTION



## STORAGE

### TOPCASE (35L) WITH BACKREST PAD

This topcase is mounted on the luggage carrier and offers enough space for a helmet with its volume of 35 litres. The waterproof luggage box is available with lid trims in the same body colour as the Maxi-Scooter itself. The reflector on the lid is standard, the liner, backrest pad and vehicle lock are among the handy options.

The comfortable backrest pad for the 35l topcase offers the passenger more comfort both on short trips and long tours.

Only available in conjunction with luggage grid.  
For information on individual speed and load limitations, please refer to the instruction booklet.



## ERGONOMICS & COMFORT

### LUGGAGE GRID



The sturdy, stylish luggage carrier is ideal for reliably securing the topcase or other large items of luggage. An optional backrest can also be fitted to provide additional comfort for the passenger.

### TOURING WINDSCREEN



The touring windscreen has a scratch-resistant coating on both sides and provides an excellent view even after travelling many miles on the road. It is approx. 20 cm higher than the standard windscreen and offers maximum wind and weather protection for rider and passenger – with minimum air turbulence at the same time.

### COMFORT SEAT

The black comfort seat offers the rider a noticeable improvement in seating comfort and even more carefree miles. Its even weight distribution increases the rider's contact area with the motorcycle and thus enables improved vehicle control.

**Comfort seat**  
Seat height: 785 mm,  
step length: 1,770 mm



### HEATED GRIPS AND SWITCHES

Comfort meets safety. The practical heated grip keeps hands pleasantly warm even on cold days, while being even more responsive. The grip heating controlled by the on-board computer continuously detects the outside temperature via sensors and adjusts the heat output.

For more detailed information, contact your authorised BMW Motorrad dealership or go online at [bmw-motorrad.com](http://bmw-motorrad.com).  
To be fitted and/or enabled in a specialist workshop, ideally at your authorised BMW Motorrad dealership.





# NAVIGATION & COMMUNICATION

## BMW MOTORRAD NAVIGATOR VI



The BMW Motorrad Navigator VI without pre-installed maps makes route planning child's play, and provides a range of additional functions which turn every tour into a real adventure. The five-inch touch screen is waterproof, easy to read even in direct sunlight, and guarantees the necessary overview at all times.

BMW Motorrad navigation devices and the BMW Motorrad smartphone cradle can only be mounted using the BMW Motorrad navigation device bracket. For more detailed information, contact your authorised BMW Motorrad dealership or go online at [bmw-motorrad.com](http://bmw-motorrad.com).

## BMW MOTORRAD SMARTPHONE CRADLE



BMW Motorrad's robust smartphone cradle provides a safe and protected place for your smartphone. This means that useful functions such as navigation information and online information can also be used while you are on the move. Thanks to the handy charging function, your smartphone is also always ready for action on extended bike tours.

Only in combination with bracket for BMW Motorrad navigation devices.

# SAFETY

## ASPHERICAL MIRROR

The aspherical mirror glass with its curved surface enlarges the field of view and almost completely eliminates the blind spot.

Model shown: C 650 GT, 2015.

To be fitted and/or enabled in a specialist workshop, ideally at your authorised BMW Motorrad dealership.



## ANTI-THEFT ALARM SYSTEM (NOT SHOWN)

NEW

Strong protection from theft: If the motorcycle is moved or struck violently, the anti-theft alarm system responds with a clearly audible signal and a flashing warning light. The acoustic and optical warning will draw the attention of passers-by quickly. The alarm system is activated automatically when the ignition is switched off.

To be fitted and/or enabled in a specialist workshop, ideally at your authorised BMW Motorrad dealership.

# MAINTENANCE & TECHNOLOGY

## AC QUICK-CHARGE CABLE

Suitable for public charging stations and 16-A AC wallboxes, the AC quick-charge cable reduces charging time by up to 25% and can be stored securely under the seat. Available with 3 ECE standard plugs

Please check your local infrastructure in advance.

### 1 Type 2 AC quick-charge cable



### 2 Type 3 AC quick-charge cable



### 3 Type CEE AC quick-charge cable



Original BMW Motorrad equipment is available from your authorised BMW Motorrad dealership.





# TOUR

<b>R 1250 RT</b>	<b>94</b>	<b>K 1600 B</b>	<b>128</b>
<b>K 1600 GT</b> Model codes 0F01, 0F11	<b>108</b>	<b>K 1600 GA</b>	<b>134</b>
<b>K 1600 GTL</b> Model codes 0F02, 0F12	<b>118</b>		

**YOUR QUEST LIES NOT IN  
SETTLING DOWN BUT IN  
FINDING YOUR OWN  
PATH TO HAPPINESS.**





# ACCESSORIES FOR BMW R 1250 RT



## HP PARTS

### HP SPORT SILENCER



The titanium-clad HP sport silencer delivers an impressively rich sound and is a clear avowal to racing, both visually and acoustically. The high-quality slip-on model offers a weight saving of approx. 0.8kg compared to the standard model thanks to its lightweight design.

### HP COVERS FOR EXPANSION TANKS



The HP cover for expansion tanks made of anodised aluminium also adds to the bike's sporty character. The high-quality milled cover with HP branding emphasises the high-performance claim and also provides for an attractive customisation of the bike.

### HP HAND LEVER, ADJUSTABLE



The CNC-milled HP hand levers made of anodised aluminium combine functionality and aesthetics. The grip width can be adjusted in five steps (brake lever) or three steps (clutch lever) using a setting screw and thus adapted to individual requirements. The look with HP logo also emphasises the bike's sportiness.

### HP ENGINE HOUSING COVER, FRONT



The HP engine housing cover made of anodised aluminium also adds to the bike's sporty character. The high-quality milled cover and HP branding emphasise the high-performance standard and also guarantee an attractive customisation of the bike.

### HP CYLINDER HEAD COVERS



The HP cylinder head covers made of anodised aluminium give the boxer engine an attractive appearance. The high-quality milled covers and HP branding highlight the motorcycle's sporty character. The HP oil filler plug perfectly matches the cylinder head covers.

## STORAGE

### LINERS FOR TOURING CASES



The tough liners make it easier to load and unload the cases, and are also water-resistant. The practical interior has dividers for holding items in place, and the outer pockets are ideal for small items. With carry handles and detachable shoulder strap.

### IMPACT PROTECTION SYSTEM FOR TOURING CASES



Made of sturdy plastic, protects top, bottom and sides of cases.

#### Protective film for top of touring cases (not shown)

To be fitted and/or enabled in a specialist workshop, ideally at your authorised BMW Motorrad dealership.



TOURING TOPCASE

This high-quality touring topcase with backrest pad and full equipment offers 49 litres of storage space. The waterproof luggage box with painted lid has two gas pressure dampers, interior lighting and carpet lining. The lock can be conveniently operated via central locking. The maximum load is 10 kg.

**7&8**  
To be fitted and/or enabled in a specialist workshop, ideally at your authorised BMW Motorrad dealership.

1 Touring topcase, Blue planet, 49 l



2 Touring topcase, Sparkling storm metallic, 49 l



3 Touring topcase, Stardust metallic, 49 l NEW



4 Touring topcase, Carbon black, 49 l



5 Touring topcase, White aluminium, 49 l



6 Light touring topcase, White aluminium, 49 l



7 Backrest pad for topcase, dark brown NEW



8 Backrest pad for touring topcase, brown



LINER FOR TOURING TOPCASE



The matching liner for the touring topcase gets the luggage organised and facilitates loading and unloading. The carry handle and shoulder strap make the bag easy to access and transport. Practical details include two external patch pockets and a wide-opening lid.

STORAGE COMPARTMENT FOR TOPCASE



The practical solution for documents, stationery or even a netbook: the handy document compartment is secured in the topcase lid with four quick-release fasteners, and helps keep things organised while providing quick access to everything that is important for the trip.

ADDITIONAL BRAKE LIGHT FOR TOPCASE



The additional brake light for the touring topcase with modern LED technology in a white clear-glass look blends perfectly with the existing topcase lid embellisher. Because braking activity can be seen better, this promotes passive safety in traffic.

To be fitted and/or enabled in a specialist workshop, ideally at your authorised BMW Motorrad dealership.

SMALL TOPCASE, 28 L

With a volume of 28 litres, the waterproof topcase offers enough space for a helmet and impresses in daily use and on short tours. It is made of a hard-wearing plastic mix in a double-shell design. Its weight is approx. 5.5 kilograms. Backrest pad also available (not shown).

LINER FOR SMALL TOPCASE

The matching liner for the small topcase gets the luggage organised and facilitates loading and unloading. The carry handle and shoulder strap make the bag easy to access and transport. Practical details include the three-sided all-round zipper.

1 Small topcase



2 Backrest pad for small topcase



TANK BAG, 11 L

The small, 11 litre tank bag with belt attachment made of durable polyester fabric is the ideal companion for short trips. The waterproof main compartment with liner, the exterior pocket with bottle holder, the carry handle and the removable shoulder strap are handy qualities that leave almost nothing to be desired.

For information on speed and load restrictions, please refer to the instruction booklet.





# DESIGN

## OPTION 719 CLASSIC WHEEL

The high-quality Option 719 Classic wheel comes in an attractive bicolour look with elaborate contrast milling. The special workmanship of the cast wheel surface gives the machine an exclusive, high-quality character.

## OPTION 719 SPORT WHEEL

The high-quality Option 719 Sport wheel comes in an attractive bicolour look with elaborate contrast milling. The special workmanship of the cast wheel surface gives the machine an exclusive, high-quality character.

### 1 Option 719 Classic front wheel



### 1 Option 719 Sport front wheel



### 2 Option 719 Classic rear wheel



### 2 Option 719 Sport rear wheel



## REAR-WHEEL COVER

The milled aluminium rear-wheel cover emphasises the dynamic design of the bike. The black anodised covers with BMW Motorrad inscription and a diameter of 62 mm enhance the motorcycle visually and technically.



## CHROME PARTS

Choose the look you want: these elegant, high-quality chrome parts can be combined as you wish, giving your BMW R 1250 RT a unique, stylish edge.

To be fitted and/or enabled in a specialist workshop, ideally at your authorised BMW Motorrad dealership.

### 1 Chrome-plated case strip



### 2 Chrome-plated touring topcase lid trim



## OPTION 719 CLASSIC HAND LEVERS, ADJUSTABLE



## OPTION 719 CLASSIC COVERS FOR EXPANSION TANKS



The Classic hand levers of the exclusive Option 719 are milled from an anodised aluminium alloy. The grip width can be adjusted in five steps (brake lever) or three steps (clutch lever) using a setting screw and thus adapted to individual requirements. The high-quality Billet Pack parts with Option 719 branding add value to the bike.

To be fitted and/or enabled in a specialist workshop, ideally at your authorised BMW Motorrad dealership.

The Option 719 Classic covers for expansion tanks set an elegant, design highlight with their silver-coloured appearance. The milled cover made of anodised aluminium bears the inscription "Option 719". Together with the other special parts of Option 719 an exclusive customisation effect is created.



---

OPTION 719 CLASSIC ENGINE HOUSING COVER, FRONT



The Option 719 Classic engine housing cover sets an elegant, design highlight with its silver-coloured look. The high-quality milled cover made of anodised aluminium bears the "Option 719" inscription. Together with the other special parts of Option 719 an exclusive customisation effect is created.

To be fitted and/or enabled in a specialist workshop, ideally at your authorised BMW Motorrad dealership.

---

OPTION 719 CLASSIC CYLINDER HEAD COVERS



The Classic cylinder head covers of the exclusive Option 719 add design highlights with their silver-coloured look. The high-quality milled covers made of anodised aluminium bring the boxer engine into the spotlight. The exclusive special parts bear the inscription "Option 719" and emphasise the high-quality character of the bike.

To be fitted and/or enabled in a specialist workshop, ideally at your authorised BMW Motorrad dealership.

---

OPTION 719 CLASSIC OIL FILLER PLUG



---

CHROME-PLATED EXHAUST MANIFOLD

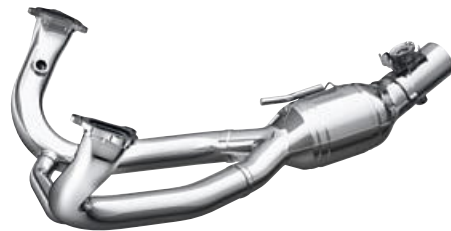

The chrome-plated exhaust manifold further enhances the motorcycle's appearance. This elegant manifold can be combined with the standard silencer or the HP sport silencer

---

CHROME-PLATED REAR SILENCER  
(NOT SHOWN)

The high-quality chrome-plated rear silencer perfectly harmonises with other motorcycle chrome applications.





# ERGONOMICS & COMFORT

## RIDER AND PASSENGER SEATS

The rider seat in black is 20 mm higher and offers particularly tall riders noticeably better seating comfort. 20 mm lower than the standard version, this black rider's seat makes climbing on and off easier and keeps the ground within easy reach. The rider seat in classic black can be adjusted and has the same seat height as the standard seat. Rider seats and passenger seats are also available with seat heating.

**High rider seat with seat heating, black, (not shown)**

**Low rider seat with seat heating, black, (not shown)**

**Rider seat with seat heating, Black, (not shown)**

**1 High rider seat, black**

**2 Low rider seat, black**



**3 Rider seat, black**

**4 Passenger seat, black**



## WINDSCREENS

The higher and wider Comfort windscreen offers maximum wind and weather protection and increased travel comfort for rider and passenger. The scratch-resistant coating ensures long-term unimpeded visibility.

Measuring 681 mm, the short windscreen is shorter than the standard windscreen and gives the bike a sporty look.

**1 Comfort windscreen**

**2 Low windscreen**



## PRO GEAR-SHIFT ASSIST



The shift assistant Pro allows shifting up and down in almost all load ranges and engine speed ranges without actuating the clutch or throttle. The assistant thus ensures noticeably reduced shifting times, a relief of the clutch hand and thus greater comfort and dynamics.

## CENTRE STAND



The stable centre stand ensures a safe stand for the motorcycle even on slopes and offers advantages, for example, when refuelling, mounting cases and topcases or checking tyre pressure. The motorcycle also takes up less space when parked upright.

## CRUISE CONTROL RETROFITTING (NOT SHOWN)

The electronic cruise control can be activated from 30 km/h and keeps the driving speed constant. This makes it possible to enjoy longer motorway stretches in a relaxed style. The function is deactivated on braking, and the selected speed is automatically adopted after activating the Resume button.

To be fitted and/or enabled in a specialist workshop, ideally at your authorised BMW Motorrad dealership.

## PRO RIDING MODES RETROFIT SET (NOT SHOWN)

Pro riding modes with three additional RACE Pro modes and various assistance systems open up the whole world of race track performance to the rider.

To be fitted and/or enabled in a specialist workshop, ideally at your authorised BMW Motorrad dealership.

## HILL START CONTROL RETROFIT SET (NOT SHOWN)

The Hill Start Control (HSC) drive-off assistant can be retrofitted using an enabling code.

To be fitted and/or enabled in a specialist workshop, ideally at your authorised BMW Motorrad dealership. For more detailed information, contact your authorised BMW Motorrad dealership or go online at [bmw-motorrad.com](http://bmw-motorrad.com).

Original BMW Motorrad equipment is available from your authorised BMW Motorrad dealership.

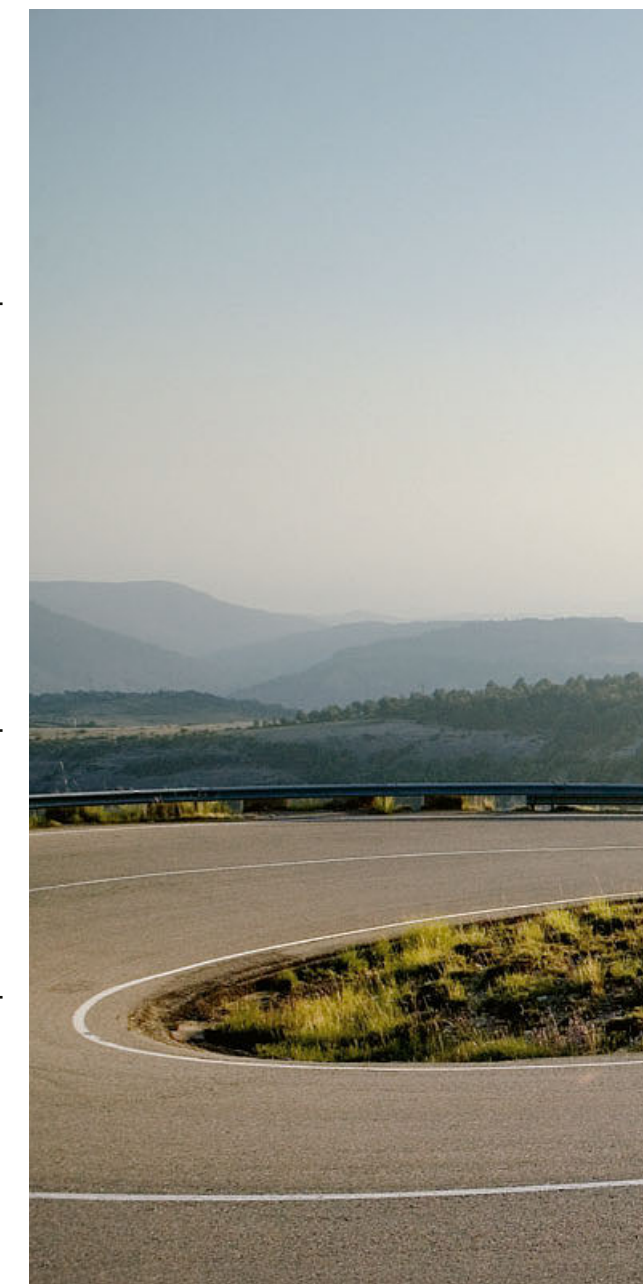



# NAVIGATION & COMMUNICATION

## BMW MOTORRAD NAVIGATOR VI



With the multifunctional Navigator VI, route planning becomes child's play. The system with 16 GB flash memory and a five-inch touch screen always shows the right way. Thanks to the circular polarisation filter (CPOL), the waterproof display is easy to read even in direct sunlight. The high-resolution screen in a casing similar to a smartphone provides all the essential information and ensures that you can see the big picture required in every situation. Numerous additional functions make planning and touring an exciting experience. Plan your routes can be created according to your personal preferences and enjoy driving on winding and quiet side roads. In unknown terrain, the "round trip" option is a good choice as it reliably guides the rider at the end of the tour back to the starting point. The Bluetooth connection to the BMW Motorrad communication system and the optional Smartphone Link app enable multimedia on the go: navigation announcements, telephone calls and music streaming as well as the retrieval of weather forecasts or traffic jam information are no problem. Navigation preparation adds further functions such as "My Motorcycle", and the multi-controller on the handlebars offers an alternative control option. Choose the pre-installed map data, and you will always be up to date thanks to lifelong, free map updates.

Note the differences in national-market versions.  
Only available in conjunction with OE navigation preparation.

## AUDIO SYSTEM RETROFIT SET (NOT SHOWN)

The audio system with radio function has MP3 player, iPod and USB stick interfaces. Operation is via the Multi-Controller on the handlebars or the radio control panel. The station, the current music track or the selected volume are displayed on the info screen.

Please note the specifications for different countries.

## DAB+ RETROFIT SET (NOT SHOWN)

NEW



## LED AUXILIARY HEADLIGHTS



The powerful LED additional headlights deliver the necessary perspective when visibility is poor thanks to extended illumination.

To be fitted and/or enabled in a specialist workshop, ideally at your authorised BMW Motorrad dealership. The additional headlights are approved for use as fog lights, and may only be used in poor weather conditions. Country-specific road traffic regulations apply.

## TYRE PRESSURE CONTROL RETROFIT SET (NOT SHOWN)

Tyre Pressure Control (TPC) with all functions can be retrofitted by installing the control unit. TPC provides reliable information about the current tyre pressure and warns the rider about pressure loss at an early stage. The corresponding notifications and instructions are provided by the on-board computer in the cockpit.

To be fitted and/or enabled in a specialist workshop, ideally at your authorised BMW Motorrad dealership.

## SAFETY SCREW FOR OIL FILLER CAP



The safety screw for the oil filler neck is locked using a special Allen® key, preventing theft of the cover. At the same time, unauthorised access and contamination of the oil by foreign substances is prevented. The high-quality aluminium lock has a BMW Boxer inscription.

## Safety screw plug for oil filler neck, black (not shown, NEW)

## ANTI-THEFT ALARM RETROFIT SET (NOT SHOWN)

NEW

Strong protection from theft: If the motorcycle is moved or struck violently, the anti-theft alarm system responds with a clearly audible signal and a flashing warning light. The acoustic and optical warning will draw the attention of passers-by quickly. The alarm system is activated automatically when the ignition is switched off.

Note the differences in national-market versions.  
To be fitted and/or enabled in a specialist workshop, ideally at your authorised BMW Motorrad dealership.

## CYLINDER HEAD COVER GUARD



The stainless steel cylinder-head cover guard provides excellent protection for the cylinder head cover, preventing scratches and damage caused by flying stones. It has been perfectly matched to the vehicle, is equipped with a large rubber bumper and optimally emphasises the design and contours of the boxer engine.

## DAYTIME RUNNING LIGHT RETROFIT SET (NOT SHOWN)



# MAINTENANCE & TECHNOLOGY

---

## ADDITIONAL POWER SOCKET

Electronic devices can be connected to the vehicle electrical system via the 12V power socket. One example of this is the BMW USB charger, which can be used to charge and operate mobile phones and MP3 players with an appropriate interface while riding.

To be fitted and/or enabled in a specialist workshop, ideally at your authorised BMW Motorrad dealership.





# ACCESSORIES FOR BMW K 1600 GT



## HP PARTS

### HP SPORT SILENCER

The titanium-clad HP sport silencer delivers an impressively rich sound and is a clear avowal to racing, both visually and acoustically. The high-quality, twin-pipe slip-on model leads into three tailpipes on each side and offers a weight saving of approx. 4.3 kg compared to the standard model.



To be fitted and/or enabled in a specialist workshop, ideally at your authorised BMW Motorrad dealership.

## STORAGE

### LINER AND IMPACT PROTECTION FOR TOURING CASES

The matching liner for the touring case gets the luggage organised and facilitates loading and unloading. The carry handle and shoulder strap make the bag easy to access and transport. The practical details include the outside pocket and the three-sided zipper.

The impact protection is made of sturdy plastic and protects the touring case at the front, bottom and sides from scratches and damage.

To be fitted and/or enabled in a specialist workshop, ideally at your authorised BMW Motorrad dealership.

#### 1 Liner for touring cases



#### 2 Impact protection for touring cases



### TOURING TOPCASE

This high-quality touring topcase with backrest pad and full equipment offers a large storage space of 49 litres.

For information on speed and load limitations, please refer to the instruction booklet.

#### 1 Touring topcase, Black storm metallic, 49 l



#### 2 Touring topcase, Blue planet, 49 l



#### 3 Touring topcase, Glacier silver metallic, 49 l



#### 4 Touring topcase, Sparkling storm metallic, 49 l



#### 5 Touring topcase, Stardust metallic, 49 l

NEW



Original BMW Motorrad equipment is available from your authorised BMW Motorrad dealership.



**BACKREST PAD FOR TOURING TOPCASE**

Relaxed on the road even on long stretches: thanks to the comfortable backrest pad in brown or dark brown, the passenger can enjoy improved comfort both on short trips and on long tours. In addition, the pad's colour harmonises with the Option 719 seat and helps the passenger to relax and experience the ride even more intensively.

To be fitted and/or enabled in a specialist workshop, ideally at your authorised BMW Motorrad dealership.

**1 Backrest pad for touring topcase, brown**



**2 Backrest pad for touring topcase, dark brown**



NEW

**LINER FOR TOURING TOPCASE**

The matching liner for the touring topcase gets the luggage organised and facilitates loading and unloading.



**STORAGE COMPARTMENT FOR TOPCASE**



The perfect solution for documents, stationery or even your tablet: this handy compartment has four quick-release fasteners for attaching to the lid of the topcase, and helps keep things tidy while providing ready access to important items.

**ADDITIONAL BRAKE LIGHT FOR TOURING TOPCASE**



The clear-glass LED additional brake light enhances passive safety and blends perfectly into the existing topcase lid cover.

To be fitted and/or enabled in a specialist workshop, ideally at your authorised BMW Motorrad dealership.

**TANK BAG**



The watertight main compartment of the tank bag can be expanded from 10 l to 12 l and features a small transparent window with a cradle for mobile phones. Also includes two exterior pockets and one interior pocket for stowing small items securely. With carry handle and detachable shoulder strap.

For information on speed and load limitations, please refer to the instruction booklet.

**PROTECTIVE FILM FOR TOURING CASE (NOT SHOWN)**

Self-adhesive and transparent, protects top and sides of cases and prevents unsightly scratches.

To be fitted and/or enabled in a specialist workshop, ideally at your authorised BMW Motorrad dealership.

**STORAGE COMPARTMENTS**

Practical storage compartments on the front sides of the motorcycle provide even more comfort.

Not available in conjunction with front footrest. To be fitted and/or enabled in a specialist workshop, ideally at your authorised BMW Motorrad dealership.

**1 Storage compartment, left**



**2 Storage compartment, right**



**DESIGN**

**OPTION 719 CLASSIC FORGED WHEELS**

The high-quality Classic forged wheel of the exclusive Option 719 adds impressive visual highlights with its all-round gloss milling.

To be fitted and/or enabled in a specialist workshop, ideally at your authorised BMW Motorrad dealership.

**1 Option 719 Classic forged wheels, front**



**2 Option 719 Classic forged wheels, rear**



**LED GROUND-LEVEL LIGHTING**

Safe parking after sunset: the LED floor lighting illuminates the area under the bike and makes it easier to find a suitable standing space in the dark. In addition, getting off the bike and operating the main or side stands is even more secure. Even small items such as keys or coins are easier to find.

Note the differences in national-market versions. To be fitted and/or enabled in a specialist workshop, ideally at your authorised BMW Motorrad dealership. Only available in conjunction with OE 417 (central locking system)





**CHROME PARTS**

Choose the look you want: these elegant, high-quality chrome parts can be combined as you wish, giving your BMW K 1600 GT a unique, stylish edge.

To be fitted and/or enabled in a specialist workshop, ideally at your authorised BMW Motorrad dealership.

**1 Windscreen trim, chrome-plated**



**2 Slipstream deflector, chrome-plated**



**3 Case strip, chrome-plated**



**4 Touring topcase lid trim, chrome-plated**



**ERGONOMICS & COMFORT**

**ONE-PIECE SEAT**

The wider one-piece seat with decorative stitching is generously padded and offers excellent comfort for both rider and passenger alike when touring. It is available in three seat heights – 750, 780 and 810 mm – and can be heated.

**Low one-piece seat (not shown)**  
Seat height: 750 mm,  
step length: 1,720 mm

**One-piece seat**  
Seat height: 780 mm,  
step length: 1,770 mm

**High one-piece seat (not shown)**  
Seat height: 810 mm,  
step length: 1,830 mm



**HEIGHT-ADJUSTABLE RIDER SEAT**

The height of the rider's seat can be adjusted in two positions to suit individual requirements. It improves seating comfort for various rider statures and allows for even more carefree kilometres even on long journeys.

**Height-adjustable rider seat, low (not shown)**  
Seat height: 780 mm/800 mm,  
step length: 1,775 mm/1,810 mm

**Height-adjustable rider seat**  
Seat height: 810 mm/830 mm,  
step length: 1,830 mm/1,870 mm





**WINDSCREENS**

The GT windscreen underlines the dynamic appearance of the motorcycle and offers good protection against wind and weather.

The scratch-resistant comfort windscreen is higher than the standard windscreen and offers maximum wind and weather protection for rider and passenger.

The low windscreen gives the bike a sporty look and offers good protection against wind and weather.

To be fitted and/or enabled in a specialist workshop, ideally at your authorised BMW Motorrad dealership.

**1 GT windscreen**



**2 Comfort windscreen**



**3 Low windscreen**



**SHIFT ASSISTANT PRO RETROFIT SET (NOT SHOWN)**

The Shift Assistant Pro makes it easy to shift up and down without actuating the clutch.

To be fitted and/or enabled in a specialist workshop, ideally at your authorised BMW Motorrad dealership.

**HILL START CONTROL RETROFIT SET (NOT SHOWN)**

The Hill Start Control (HSC) drive-off assistant can be retrofitted using an enabling code.

To be fitted and/or enabled in a specialist workshop, ideally at your authorised BMW Motorrad dealership.

**CRUISE CONTROL RETROFIT SET (NOT SHOWN)**

The electronic cruise control can be activated from 30km/h and keeps the riding speed constant. This makes it possible to enjoy longer motorway stretches in a relaxed style. The function is deactivated on braking, and the selected speed is automatically adopted after activating the resume button.

To be fitted and/or enabled in a specialist workshop, ideally at your authorised BMW Motorrad dealership.



# NAVIGATION & COMMUNICATION

**BMW MOTORRAD NAVIGATOR VI**



Not only touring fans will have plenty of choice with the Navigator VI. The system makes route planning child's play and offers numerous additional functions that make every tour an exciting experience. The five inch touch screen is waterproof, easy to read even in direct sunlight and ensures that you can see the big picture required in every situation.

Note the differences in national-market versions.  
 Only available in conjunction with OE navigation preparation.

**AUDIO SYSTEM RETROFIT SET (NOT SHOWN)**

The audio system with radio function has MP3 player, iPod and USB stick interfaces. Operation is via the Multi-Controller on the handlebars or the radio control panel. The station, the current music track or the selected volume are displayed on the info screen.

Please note the specifications for different countries.

Original BMW Motorrad equipment is available from your authorised BMW Motorrad dealership.





## SAFETY

### LED AUXILIARY HEADLIGHTS

The powerful LED additional headlights in a compact aluminium housing ensure better vision and visibility even in fog, rain or snowfall. At the same time, their white, daylight-like light colour ensures differentiated illumination of the roadway. LED technology ensures virtually wear-free operation.

To be fitted and/or enabled in a specialist workshop, ideally at your authorised BMW Motorrad dealership.



### ANTI-THEFT ALARM RETROFIT SET (NOT SHOWN)

NEW

If the Anti-theft Alarm System is moved or struck violently, the system responds with a clearly audible signal and a hazard warning indicator lamp.

Note the differences in national-market versions. To be fitted and/or enabled in a specialist workshop, ideally at your authorised BMW Motorrad dealership.

### TYRE PRESSURE CONTROL RETROFIT SET (NOT SHOWN)

Tyre Pressure Control (TPC) with all functions can be retrofitted by installing the control unit. TPC provides reliable information about the current tyre pressure and warns the rider about pressure loss at an early stage. The corresponding notifications and instructions are provided by the on-board computer in the cockpit.

To be fitted and/or enabled in a specialist workshop, ideally at your authorised BMW Motorrad dealership.

### ENGINE PROTECTION BAR

The tough two-piece engine protection bar is made of stainless steel with a bead-blasted matt finish. It protects the engine cover against serious impacts, while blending in perfectly with the stylish profile of the BMW K 1600 GT.



### FOOT PROTECTION (NOT SHOWN)

## MAINTENANCE & TECHNOLOGY

### POWER SOCKET

Electronic devices can be connected to the vehicle electrical system via the 12V power socket. One example of this is the BMW USB charger, which can be used to charge and operate mobile phones and MP3 players with an appropriate interface while riding.

To be fitted and/or enabled in a specialist workshop, ideally at your authorised BMW Motorrad dealership.





# ACCESSORIES FOR BMW K 1600 GTL



## HP PARTS

### HP SPORT SILENCER

The titanium-clad HP sport silencer delivers an impressively rich sound and is a clear avowal to racing, both visually and acoustically. The high-quality, twin-pipe slip-on model leads into three tailpipes on each side and offers a weight saving of approx. 4.3 kg compared to the standard model.

To be fitted and/or enabled in a specialist workshop, ideally at your authorised BMW Motorrad dealership.



## STORAGE

### STORAGE COMPARTMENTS

Practical storage compartments on the front sides of the motorcycle provide even more comfort.

To be fitted and/or enabled in a specialist workshop, ideally at your authorised BMW Motorrad dealership.

#### 1 Storage compartment, left



#### 2 Storage compartment, right



### LINER FOR TOURING CASES

The matching liner for the touring case gets the luggage organised and facilitates loading and unloading. The carry handle and shoulder strap make the bag easy to access and transport. The practical details include the outside pocket and the three-sided zipper.

### ADDITIONAL BRAKE LIGHT FOR TOURING TOPCASE

The clear-glass LED additional brake light enhances passive safety and blends perfectly into the existing topcase lid cover.

To be fitted and/or enabled in a specialist workshop, ideally at your authorised BMW Motorrad dealership.





**IMPACT PROTECTION SYSTEM FOR TOURING CASES**

The impact protection for the touring case is made of sturdy plastic and offers effective protection against scratches and other damage.

To be fitted and/or enabled in a specialist workshop, ideally at your authorised BMW Motorrad dealership.



**LINER FOR TOURING TOPCASE**

The matching liner for the touring topcase gets the luggage organised and facilitates loading and unloading.



**STORAGE COMPARTMENT FOR TOURING TOPCASE**

The perfect solution for documents, stationery or even your tablet: this handy compartment has four quick-release fasteners for attaching to the lid of the topcase, and helps keep things tidy while providing ready access to important items.



**PROTECTIVE FILM FOR TOP TOURING CASE (NOT SHOWN)**

The self-adhesive and transparent film protects top and side surfaces of touring cases from small scratches.

To be fitted and/or enabled in a specialist workshop, ideally at your authorised BMW Motorrad dealership.

# DESIGN

**OPTION 719 CLASSIC FORGED WHEELS**

The high-quality Classic forged wheel of the exclusive Option 719 presents itself in an elegant two-colour look with all-round polish milling. The special surface treatment with detailed milling contours and the nine-spoke design give the touring bikes a soft and particularly valuable appearance.

To be fitted and/or enabled in a specialist workshop, ideally at your authorised BMW Motorrad dealership.

1 Option 719 Classic forged wheels, front



2 Option 719 Classic forged wheels, rear



Original BMW Motorrad equipment is available from your authorised BMW Motorrad dealership.



**CHROME PARTS**

Choose the look you want: these elegant, high-quality chrome parts can be combined as you wish, giving your BMW K 1600 GTL a unique, stylish edge.

To be fitted and/or enabled in a specialist workshop, and ideally at your authorised BMW Motorrad dealership.

**1 Case trim, chrome-plated**



**2 Case strip, chrome-plated**

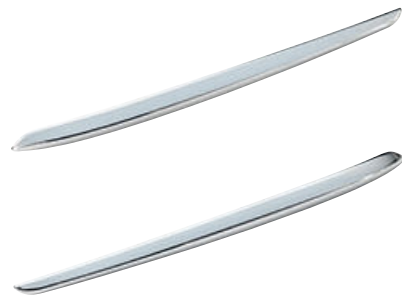

**3 Mirror cap, chrome-plated**



**4 Touring topcase lid trim, chrome-plated**



**5 Wind deflector, chrome-plated**



**6 Slipstream deflector, chrome-plated**



**7 Windscreen trim, chrome-plated**



**ERGONOMICS & COMFORT**

**LED GROUND-LEVEL LIGHTING**

Safe parking after sunset: the LED floor lighting illuminates the area under the bike and makes it easier to find a suitable standing space in the dark. In addition, getting off the bike and operating the main or side stands is even more secure. Even small items such as keys or coins are easier to find.

Note the differences in national-market versions.  
To be fitted and/or enabled in a specialist workshop, ideally at your authorised BMW Motorrad dealership.  
Only in conjunction with OE 417 (central locking system)



**WINDSCREENS**

The GT windscreen underlines the dynamic appearance of the motorcycle and offers good protection against wind and weather.

The scratch-resistant coated comfort windscreen is higher than the standard windscreen and provides the rider and passenger with the maximum wind and weather protection.

The low windscreen gives the bike a sporty look and offers good protection against wind and weather.

To be fitted and/or enabled in a specialist workshop, ideally at your authorised BMW Motorrad dealership.

**1 GT windscreen**



**2 Comfort windscreen**



**3 Low windscreen**



Original BMW Motorrad equipment is available from your authorised BMW Motorrad dealership.



**ONE-PIECE SEAT**

The wider one-piece seat with decorative stitching is generously padded and offers excellent comfort for both rider and passenger alike when touring. It is available in three seat heights – 750, 780 and 810 mm – and can be heated.

**Low one-piece seat (not shown)**  
Seat height: 750 mm,  
step length: 1,720 mm

**One-piece seat**  
Seat height: 780 mm,  
step length: 1,770 mm

**High one-piece seat (not shown)**  
Seat height: 810 mm,  
step length: 1,830 mm



**HEIGHT-ADJUSTABLE RIDER SEAT**

The height of the rider's seat can be adjusted in two positions to suit individual requirements. It improves seating comfort for various rider statures and allows for even more carefree kilometres even on long journeys.

**Height-adjustable rider seat**  
Seat height: 810 mm/830 mm,  
step length: 1,830 mm/1,870 mm

**Height-adjustable rider seat, low (not shown)**  
Seat height: 780 mm/800 mm,  
step length: 1,775 mm/1,810 mm



**ARMRESTS FOR PASSENGER**

The padded armrests for the passenger offer relaxed travel comfort and can be easily folded up for conveniently getting on and off.

To be fitted and/or enabled in a specialist workshop, ideally at your authorised BMW Motorrad dealership.

**1 Armrests for passenger**



**2 Set of padding for passenger seat comfort armrest, Saddle brown**



**3 Set of padding for passenger seat comfort armrest, dark brown** NEW



**PASSENGER FOOTRESTS**

The high-quality footboards are forged from a high-strength aluminium alloy and has an anti-slip rubber surface. It is extremely robust and offers the passenger a particularly large contact area of 155 x 102 mm. A guarantee for relaxed riding comfort – especially on long journeys with a passenger.

To be fitted and/or enabled in a specialist workshop, ideally at your authorised BMW Motorrad dealership.



**HILL START CONTROL RETROFIT SET (NOT SHOWN)**

The Hill Start Control (HSC) drive-off assistant can be retrofitted using an enabling code. Therefore, the driver does not have to do without the convenient assistance system. HSC makes stopping and starting on slopes easier and offers valuable support, especially when the bike has a full load.

To be fitted and/or enabled in a specialist workshop, ideally at your authorised BMW Motorrad dealership.

**SHIFT ASSISTANT PRO RETROFIT SET (NOT SHOWN)**

The shift assistant Pro allows shifting up and down in almost all load ranges and engine speed ranges without actuating the clutch or throttle. The assistant thus ensures noticeably reduced shifting times, a relief of the clutch hand and thus greater comfort and dynamics.

To be fitted and/or enabled in a specialist workshop, ideally at your authorised BMW Motorrad dealership.

**CRUISE CONTROL RETROFIT SET (NOT SHOWN)**

The electronic cruise control can be activated from 30 km/h and keeps the riding speed constant. This makes it possible to enjoy longer motorway stretches in a relaxed style. The function is deactivated on braking, and the selected speed is automatically adopted after activating the resume button.

To be fitted and/or enabled in a specialist workshop, ideally at your authorised BMW Motorrad dealership.



Original BMW Motorrad equipment is available from your authorised BMW Motorrad dealership.



# NAVIGATION & COMMUNICATION

## BMW MOTORRAD NAVIGATOR VI

With the multifunctional Navigator VI, route planning becomes child's play. The system with 16 GB flash memory and a five-inch touch screen always shows the right way. Thanks to the circular polarisation filter (CPOL), the waterproof display is easy to read even in direct sunlight. The high-resolution screen in a casing similar to a smartphone provides all the essential information and ensures that you can see the big picture required in every situation. Numerous additional functions make planning and touring an exciting experience. Plan your routes can be created according to your personal preferences and enjoy driving on winding and quiet side roads. In unknown terrain, the "round trip" option is a good choice as it reliably guides the rider at the end of the tour back to the starting point. The Bluetooth connection to the BMW Motorrad communication system and the optional Smartphone Link app enable multimedia on the go: navigation announcements, telephone calls and music streaming as well as the retrieval of weather forecasts or traffic jam information are no problem. Navigation preparation adds further functions such as "My Motorcycle", and the multi-controller on the handlebars offers an alternative control option. Choose the pre-installed map data, and you will always be up to date thanks to lifelong, free map updates.



Note the differences in national-market versions.  
 Only available in conjunction with OE navigation preparation.

## AUDIO SYSTEM RETROFIT SET (NOT SHOWN)

The audio system with radio function has MP3 player, iPod and USB stick interfaces. Operation is via the Multi-Controller on the handlebars or the radio control panel. The station, the current music track or the selected volume are displayed on the info screen.

Note the differences in national-market versions.



# SAFETY

## ENGINE PROTECTION BAR

The tough two-piece engine protection bar is made of stainless steel with a bead-blasted matt finish. It protects the engine cover against serious impacts, while blending in perfectly with the stylish profile of the BMW K 1600 GTL.



## LED AUXILIARY HEADLIGHTS

The powerful LED additional headlights in a compact aluminium housing ensure better vision and visibility even in fog, rain or snowfall. At the same time, their white, daylight-like light colour ensures differentiated illumination of the roadway. LED technology ensures virtually wear-free operation.

To be fitted and/or enabled in a specialist workshop, ideally at your authorised BMW Motorrad dealership.



## ANTI-THEFT ALARM RETROFIT SET (NOT SHOWN)

NEW

If the Anti-theft Alarm System is moved or struck violently, the system responds with a clearly audible signal and a hazard warning indicator lamp.

Note the differences in national-market versions.  
 To be fitted and/or enabled in a specialist workshop, ideally at your authorised BMW Motorrad dealership.

## TYRE PRESSURE CONTROL RETROFIT SET (NOT SHOWN)

Tyre Pressure Control (TPC) with all functions can be retrofitted by installing the control unit. TPC provides reliable information about the current tyre pressure and warns the rider about pressure loss at an early stage. The corresponding notifications and instructions are provided by the on-board computer in the cockpit.

To be fitted and/or enabled in a specialist workshop, ideally at your authorised BMW Motorrad dealership.



Original BMW Motorrad equipment is available from your authorised BMW Motorrad dealership.



# ACCESSORIES FOR BMW K 1600 B



## STORAGE

### LINER FOR TOURING CASES

These tough liners make it easier to load and unload the cases or topcase. They're specially fitted for the cases, and the outer pockets with real leather sides are ideal for small items. Suitable for the left or right case. With shoulder strap.



### IMPACT PROTECTION SYSTEM FOR TOURING CASES

The impact protection for the touring case is made of sturdy plastic and offers effective protection against scratches and other damage.

To be fitted and/or enabled in a specialist workshop, ideally at your authorised BMW Motorrad dealership.



### STORAGE COMPARTMENTS (NOT SHOWN)

Practical storage compartments on the front sides of the motorcycle provide even more comfort. Also available as an equipment option.

Not available in conjunction with front footrest. To be fitted and/or enabled in a specialist workshop, ideally at your authorised BMW Motorrad dealership.

## DESIGN

### OPTION 719 CLASSIC FORGED WHEELS

The high-quality Classic forged wheel of the exclusive Option 719 presents itself in an elegant two-colour look with all-round polish milling. The special surface treatment with detailed milling contours and the nine-spoke design give the touring bikes a soft and particularly valuable appearance.

To be fitted and/or enabled in a specialist workshop, ideally at your authorised BMW Motorrad dealership.

#### 1 Option 719 Classic forged wheels, front



#### 2 Option 719 Classic forged wheels, rear



### CHROME PARTS

Choose the look you want: these elegant, high-quality chrome parts can be combined as you wish, giving your BMW K 1600 B a unique, stylish edge.

To be fitted and/or enabled in a specialist workshop, and ideally at your authorised BMW Motorrad dealership.

#### 1 Case trim, chrome-plated



#### 2 Mirror cap, chrome-plated



#### 3 Wind deflector, chrome-plated



#### 4 Slipstream deflector, chrome-plated



#### 5 Windscreen trim, chrome-plated





# ERGONOMICS & COMFORT

## SEAT

Instantly inviting, this seat features decorative stitching and all the padding you need, offering outstanding comfort for both rider and passenger alike when touring. Available in three seat heights. All retrofittable seats are heated. Seat available in a low or extra high version and as an equipment option.

### Low seat

Seat height: 750 mm,  
step length: 1,720 mm

### High seat (not shown)

Seat height: 780 mm,  
step length: 1,770 mm

### Extra high seat (not shown)

Seat height: 810 mm,  
step length: 1,830 mm



## WINDSCREENS

The scratch-resistant comfort windscreen is higher than the standard windscreen and offers maximum wind and weather protection for rider and passenger.

The low windscreen gives the bike a sporty look and offers good protection against wind and weather.

The short, tinted windscreen has a scratch-resistant coating. It offers great wind protection for the rider and looks very sporty thanks to its dark tint.

To be fitted and/or enabled in a specialist workshop, ideally at your authorised BMW Motorrad dealership. Please note the specifications for different countries.

### 1 Comfort windscreen



### 2 Low windscreen



### 3 Low windscreen, tinted



## PASSENGER FOOTBOARDS

The high-quality footboard is forged from a high-strength aluminium alloy and has an anti-slip rubber surface. It is extremely robust and offers the passenger a particularly large contact area of 155 x 102 mm. A guarantee for relaxed riding comfort – especially on long journeys with a passenger.

To be fitted and/or enabled in a specialist workshop, ideally at your authorised BMW Motorrad dealership.



## FRONT FOOTBOARD

These comfortable footboards provide the driver with a more relaxed, "foot-forward" riding position. Also available as an equipment option.



## LED GROUND-LEVEL LIGHTING

Safe parking after sunset: the LED floor lighting illuminates the area under the bike and makes it easier to find a suitable standing space in the dark. In addition, getting off the bike and operating the main or side stands is even more secure. Even small items such as keys or coins are easier to find.

Note the differences in national-market versions. To be fitted and/or enabled in a specialist workshop, ideally at your authorised BMW Motorrad dealership.

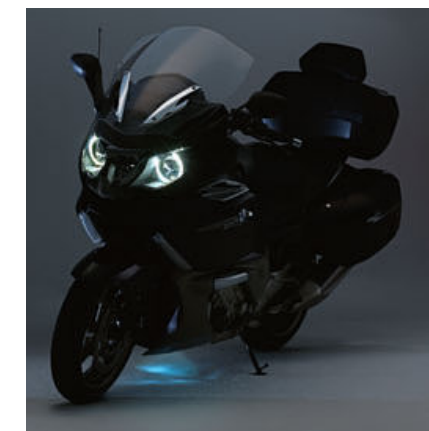

## CENTRE STAND (NOT SHOWN)

The centre stand lets you safely park your motorcycle anywhere, while taking up less space. Also available as optional equipment.

To be fitted and/or enabled in a specialist workshop, ideally at your authorised BMW Motorrad dealership.

## SHIFT ASSISTANT PRO RETROFIT SET (NOT SHOWN)

The shift assistant Pro allows shifting up and down in almost all load ranges and engine speed ranges without actuating the clutch or throttle. The assistant thus ensures noticeably reduced shifting times, a relief of the clutch hand and thus greater comfort and dynamics.

To be fitted and/or enabled in a specialist workshop, ideally at your authorised BMW Motorrad dealership.

## CRUISE CONTROL RETROFIT SET (NOT SHOWN)

The electronic cruise control can be activated from 30 km/h and keeps the riding speed constant. This makes it possible to enjoy longer motorway stretches in a relaxed style. The function is deactivated on braking, and the selected speed is automatically adopted after activating the resume button.

To be fitted and/or enabled in a specialist workshop, ideally at your authorised BMW Motorrad dealership.

## FRAME BOTTOM TRUSS COVER (NOT SHOWN)



# NAVIGATION & COMMUNICATION

## BMW MOTORRAD NAVIGATOR VI

With the multifunctional Navigator VI, route planning becomes child's play. The system with 16 GB flash memory and a five-inch touch screen always shows the right way. Thanks to the circular polarisation filter (CPOL), the waterproof display is easy to read even in direct sunlight. The high-resolution screen in a casing similar to a smartphone provides all the essential information and ensures that you can see the big picture required in every situation. Numerous additional functions make planning and touring an exciting experience. Plan your routes can be created according to your personal preferences and enjoy driving on winding and quiet side roads. In unknown terrain, the "round trip" option is a good choice as it reliably guides the rider at the end of the tour back to the starting point. The Bluetooth connection to the BMW Motorrad communication system and the optional Smartphone Link app enable multimedia on the go: navigation announcements, telephone calls and music streaming as well as the retrieval of weather forecasts or traffic jam information are no problem. Navigation preparation adds further functions such as "My Motorcycle", and the multi-controller on the handlebars offers an alternative control option. Choose the pre-installed map data, and you will always be up to date thanks to lifelong, free map updates.



Note the differences in national-market versions.  
 Only available in conjunction with OE navigation preparation.

## AUDIO SYSTEM RETROFIT SET (NOT SHOWN)

The audio system with radio function has MP3 player, iPod and USB stick interfaces. Operation is via the Multi-Controller on the handlebars or the radio control panel. The station, the current music track or the selected volume are displayed on the info screen.

Note the differences in national-market versions.

# SAFETY

## ENGINE PROTECTION BAR

The tough two-piece engine protection bar is made from stainless steel with a bead-blasted matt finish. It protects the engine cover against serious impacts while blending in perfectly with the stylish overall design of the BMW K 1600 B.



## ANTI-THEFT ALARM SYSTEM RETROFIT SET (NOT SHOWN)

NEW

If the Anti-theft Alarm System is moved or struck violently, the system responds with a clearly audible signal and a flashing warning light.

Note the differences in national-market versions.  
 To be fitted and/or enabled in a specialist workshop, ideally at your authorised BMW Motorrad dealership.

## LED AUXILIARY HEADLIGHTS

The powerful LED additional headlights in a compact aluminium housing ensure better vision and visibility even in fog, rain or snowfall. At the same time, their white, daylight-like light colour ensures differentiated illumination of the roadway. LED technology ensures virtually wear-free operation.

To be fitted and/or enabled in a specialist workshop, ideally at your authorised BMW Motorrad dealership.



## TYRE PRESSURE CONTROL RETROFIT SET (NOT SHOWN)

Tyre Pressure Control (TPC) with all functions can be retrofitted by installing the control unit. TPC provides reliable information about the current tyre pressure and warns the rider about pressure loss at an early stage. The corresponding notifications and instructions are provided by the on-board computer in the cockpit.

To be fitted and/or enabled in a specialist workshop, ideally at your authorised BMW Motorrad dealership.



Original BMW Motorrad equipment is available from your authorised BMW Motorrad dealership.



# ACCESSORIES FOR BMW K 1600 GA



## STORAGE

### LINERS FOR TOURING CASES/TOPCASE

These tough liners make it easier to load and unload the cases or topcase. They're specially fitted for the cases and topcase, and the outer pockets with real leather sides are ideal for small items. Liners for touring cases suitable for left or right case. With detachable shoulder strap.

1 Liner for touring cases



2 Liner for topcases



### IMPACT PROTECTION SYSTEM FOR TOURING CASES

The impact protection for the touring case is made of sturdy plastic and offers effective protection against scratches and other damage.

To be fitted and/or enabled in a specialist workshop, ideally at your authorised BMW Motorrad dealership.



## DESIGN

### OPTION 719 CLASSIC FORGED WHEELS

The high-quality Classic forged wheel of the exclusive Option 719 presents itself in an elegant two-colour look with all-round polish milling. The special surface treatment with detailed milling contours and the nine-spoke design give the touring bikes a soft and particularly valuable appearance.

To be fitted and/or enabled in a specialist workshop, ideally at your authorised BMW Motorrad dealership.

1 Option 719 Classic forged wheels, front



2 Option 719 Classic forged wheels, rear





**CHROME PARTS**

Choose the look you want: these elegant, high-quality chrome parts can be combined as you wish, giving your BMW K 1600 Grand America a unique, stylish edge.

To be fitted and/or enabled in a specialist workshop, and ideally at your authorised BMW Motorrad dealership.

**1 Slipstream deflector, chrome-plated**



**2 Case trim, chrome-plated**



**3 Mirror cap, chrome-plated**



**4 Topcase lid trim, chrome-plated**



**5 Wind deflector, chrome-plated**



**ERGONOMICS & COMFORT**

**SEAT**

Instantly inviting, this seat features decorative stitching and all the padding you need, offering outstanding comfort for both rider and passenger alike when touring. Available in three seat heights. All retrofittable seats are heated. Seat available in a low or extra high version and as an equipment option.

**Low seat**  
Seat height: 750 mm,  
step length: 1,720 mm

**High seat  
(not shown)**  
Seat height: 780 mm,  
step length: 1,770 mm

**Extra high seat  
(not shown)**  
Seat height: 810 mm,  
step length: 1,830 mm



**WINDSCREENS**

The scratch-resistant comfort windscreen is higher than the standard windscreen and offers maximum wind and weather protection for rider and passenger.

The short, tinted windscreen has a scratch-resistant coating. It offers great wind protection for the rider and looks very sporty thanks to its dark tint.

**Low windscreen, clear  
(not shown)**

To be fitted and/or enabled in a specialist workshop, ideally at your authorised BMW Motorrad dealership. Please note the specifications for different countries.

**1 Comfort windscreen**



**2 Low windscreen, tinted**



Original BMW Motorrad equipment is available from your authorised BMW Motorrad dealership.



#### PASSENGER FOOTRESTS

The high-quality footboards are forged from a high-strength aluminium alloy and has an anti-slip rubber surface. It is extremely robust and offers the passenger a particularly large contact area of 155x102mm. A guarantee for relaxed riding comfort – especially on long journeys with a passenger.

To be fitted and/or enabled in a specialist workshop, ideally at your authorised BMW Motorrad dealership.



#### COMFORT ARMRESTS FOR PASSENGER

The padded armrests for the passenger offer relaxed travel comfort and can be easily folded up for conveniently getting on and off.

To be fitted and/or enabled in a specialist workshop, ideally at your authorised BMW Motorrad dealership.



#### LED GROUND-LEVEL LIGHTING

Safe parking after sunset: the LED floor lighting illuminates the area under the bike and makes it easier to find a suitable standing space in the dark. In addition, getting off the bike and operating the main or side stands is even more secure. Even small items such as keys or coins are easier to find.

Note the differences in national-market versions.  
To be fitted and/or enabled in a specialist workshop, ideally at your authorised BMW Motorrad dealership.



#### SHIFT ASSISTANT PRO RETROFIT SET (NOT SHOWN)

The shift assistant Pro allows shifting up and down in almost all load ranges and engine speed ranges without actuating the clutch or throttle. The assistant thus ensures noticeably reduced shifting times, a relief of the clutch hand and thus greater comfort and dynamics.

To be fitted and/or enabled in a specialist workshop, ideally at your authorised BMW Motorrad dealership.

#### CENTRE STAND (NOT SHOWN)

The centre stand lets you safely park your motorcycle anywhere, while taking up less space. Also available as optional equipment.

To be fitted and/or enabled in a specialist workshop, ideally at your authorised BMW Motorrad dealership.

# NAVIGATION & COMMUNICATION

#### BMW MOTORRAD NAVIGATOR VI



With the multifunctional Navigator VI, route planning becomes child's play. The system with 16 GB flash memory and a five-inch touch screen always shows the right way. Thanks to the circular polarisation filter (CPOL), the waterproof display is easy to read even in direct sunlight. The high-resolution screen in a casing similar to a smartphone provides all the essential information and ensures that you can see the big picture required in every situation. Numerous additional functions make planning and touring an exciting experience. Plan your routes can be created according to your personal preferences and enjoy driving on winding and quiet side roads. In unknown terrain, the "round trip" option is a good choice as it reliably guides the rider at the end of the tour back to the starting point. The Bluetooth connection to the BMW Motorrad communication system and the optional Smartphone Link app enable multimedia on the go: navigation announcements, telephone calls and music streaming as well as the retrieval of weather forecasts or traffic jam information are no problem. Navigation preparation adds further functions such as "My Motorcycle", and the multi-controller on the handlebars offers an alternative control option. Choose the pre-installed map data, and you will always be up to date thanks to lifelong, free map updates.

Note the differences in national-market versions.  
Only available in conjunction with OE navigation preparation.

Original BMW Motorrad equipment is available from your authorised BMW Motorrad dealership.





# SAFETY

---

## LED AUXILIARY HEADLIGHTS

The powerful LED additional headlights in a compact aluminium housing ensure better vision and visibility even in fog, rain or snowfall. At the same time, their white, daylight-like light colour ensures differentiated illumination of the roadway. LED technology ensures virtually wear-free operation.

To be fitted and/or enabled in a specialist workshop, ideally at your authorised BMW Motorrad dealership.



---

## TYRE PRESSURE CONTROL RETROFIT SET (NOT SHOWN)

Tyre Pressure Control (TPC) with all functions can be retrofitted by installing the control unit. TPC provides reliable information about the current tyre pressure and warns the rider about pressure loss at an early stage. The corresponding notifications and instructions are provided by the on-board computer in the cockpit.

To be fitted and/or enabled in a specialist workshop, ideally at your authorised BMW Motorrad dealership.





# ROADSTER

G 310 R	144	S 1000 R	164
		Model code: 0D52, 0D62	
F 900 R	152	R 1250 R	174

**NEVER  
RIDE TO  
FOLLOW.**





# ACCESSORIES FOR BMW G 310 R



## STORAGE

### SMALL TOPCASE, 30 L

The waterproof plastic topcase with a volume of 30 litres offers enough space for a helmet. The lid, which is available in Black storm metallic, Light white and Racing red, and the soft-close hinges, which allow the lid to be lowered gently, underline the high-quality appeal.

Only in conjunction with luggage carrier, topcase carrier and matching outer shell. For information on speed and load limitations, please refer to the instruction booklet. For more detailed information, contact your authorised BMW Motorrad dealership or go online at [bmw-motorrad.com](http://bmw-motorrad.com).

#### 1 Black storm metallic



#### 2 Light white



#### 2 Racing red



### LIGHT TOPCASE, 29 L



With a volume of 29 litres, the light topcase offers enough space for a helmet and convinces in everyday life as well as on short tours. The black plastic topcase is lockable, has a large reflector on the rear side and a BMW badge on the lid. The maximum load is 3 kg.

Only available in conjunction with luggage grid. For information on speed and load restrictions, please refer to the instruction booklet.

### LINER FOR TOPCASE



The matching tailored liner for the topcase gets the luggage organised and facilitates loading and unloading. The carry handle and shoulder strap make the bag easy to access and transport. The practical details include the outside pocket and the three-sided zipper.

### TANK BAG, 13-20 L



The tank bag made of durable polyester offers many clever details and can be extended from 13 to 20 litres as required. Extra space is available in the map pocket and two exterior pockets. The smart fastener design guarantees a secure hold and extremely practical handling.

### LUGGAGE CARRIER



A topcase or other pieces of luggage can be attached to the sturdy luggage grid made of powder-coated die-cast aluminium.

To be fitted and/or enabled in a specialist workshop, ideally at your authorised BMW Motorrad dealership.





# DESIGN

## DECORATIVE STICKER SET

The decorative "Street" sticker set is perfectly tailored to the motorcycle and guarantees an attractive, unique look. The dynamic lines in yellow, red and blue create a modern street racer design and underline the sporty character of the machine. In addition, the rim rings of contrasting colour ensure attention.

the decorative "Wolf" sticker set is perfectly tailored to the motorcycle and creates an attractive, unique look. The lines in yellow, red and blue create a wolf motif further accentuating the dynamic design of the motorcycle. In addition, the rim rings in contrasting colour ensure lots of attention.

### 1 Decorative Street sticker set



### 2 Decorative Wolf sticker set



## LED INDICATORS



A shining example: The beautifully designed LED indicators with white turn indicator glass convince with their slim design and modern lighting technology. They respond much faster than incandescent lamps and are virtually wear-free. This provides a clear safety advantage in road traffic.

Note the differences in national-market versions.  
To be fitted and/or enabled in a specialist workshop,  
ideally at your authorised BMW Motorrad dealership.



# ERGONOMICS & COMFORT

## HIGH SEAT



The high seat has a seat height of 850 mm. This means that even tall riders enjoy a comfortable knee angle and a relaxed and comfortable seat position that helps prevent signs of fatigue.

**High seat**  
Seat height 850 mm

## LOW SEAT



15 mm lower than the standard version, this low seat makes climbing on off easier and keeps the ground within easy reach. Many riders feel safer thanks to the reduced seat height, because they can manoeuvre and control their motorcycle more easily. The high-quality surface material in black corresponds to the standard equipment.

**Low seat**  
Seat height 820 mm

## ADJUSTABLE HANDBRAKE LEVER / CLUTCH LEVER

The ergonomically optimised handbrake and clutch levers can be adjusted in four steps making it easy to attain the preferred grip width. The two-tone look with black powder coating and a chrome-plated adjustment wheel emphasises the individuality of the motorcycle.

### 1 Handbrake lever, adjustable



### 2 Clutch lever, adjustable



## HEATED GRIPS AND SWITCHES

Warm hands despite lower temperatures: This is ensured by the electric heating grips with three-stage control. This enhances comfort and also improves safety, because warm hands and more feeling in the fingers simply improves vehicle control. In addition to heating stages 1 and 2, the rider has the option of activating the outside temperature-controlled automatic transmission. The heated grips are operated via a multifunction switch on the right handlebar controls, which can also be retrofitted.

For more detailed information, contact your authorised BMW Motorrad dealership or go online at [bmw-motorrad.com](http://bmw-motorrad.com).  
To be fitted and/or enabled in a specialist workshop,  
ideally at your authorised BMW Motorrad dealership.



Original BMW Motorrad equipment is available from your authorised BMW Motorrad dealership.



# NAVIGATION & COMMUNICATION

## BMW MOTORRAD NAVIGATOR VI

With the multifunctional Navigator VI, route planning becomes child's play. The system with 16 GB flash memory and a five-inch touch screen always shows the right way. Thanks to the circular polarisation filter (CPOL), the waterproof display is easy to read even in direct sunlight. The high-resolution screen in a casing similar to a smartphone provides all the essential information and ensures that you can see the big picture required in every situation. Numerous additional functions make planning and touring an exciting experience. Plan your routes can be created according to your personal preferences and enjoy driving on winding and quiet side roads. In unknown terrain, the "round trip" option is a good choice as it reliably guides the rider at the end of the tour back to the starting point. The Bluetooth connection to the BMW Motorrad communication system and the optional Smartphone Link app enable multimedia on the go: navigation announcements, telephone calls and music streaming as well as the retrieval of weather forecasts or traffic jam information are no problem. Navigation preparation adds further functions such as "My Motorcycle", and the multi-controller on the handlebars offers an alternative control option. Choose the pre-installed map data, and you will always be up to date thanks to lifelong, free map updates.



For more detailed information, contact your authorised BMW Motorrad dealership or go online at [bmw-motorrad.com](http://bmw-motorrad.com).

## BMW MOTORRAD SMARTPHONE CRADLE

BMW Motorrad's robust smartphone cradle provides a safe and protected place for your smartphone. This means that useful functions such as navigation information and online information can also be used while you are on the move. Thanks to the handy charging function, your smartphone is also always ready for action on extended bike tours.

Only in combination with bracket for BMW Motorrad navigation systems.



# SAFETY

## HAND PROTECTORS



The hand protector, made of impact-resistant and UV-resistant plastic, also protects the operating elements against branches and stone chips while riding off-road, and is aerodynamically tailored to the vehicle. On the road, the wind and weather protection offered by the protectors is also impressive: hands and fingers stay longer dry and warm even at low temperatures.

## ENGINE PROTECTION BAR

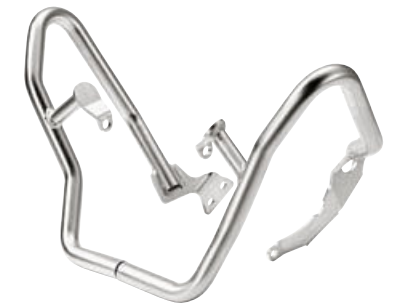

The robust engine protection bars, made of polished stainless steel, reliably protect the bike against damage without restricting the rider's freedom to lean the machine. The robust tube construction will even take hard knocks and prevent major fall damage off-road and on asphalt.

Both the combination with the standard engine spoiler and with the aluminium bash plate is possible.

## ALUMINIUM BASH PLATE

The robust and lightweight aluminium engine guard effectively protects the lower area of the motorcycle against stone chips and damage, such as when bottoming out. It is wider and longer than the standard engine guard. Its elegant design emphasises the high-quality character of the bike. (Model shown: G 310 GS)



## SPRAY GUARD COVER (NOT SHOWN)

The rear-wheel cover with splash protection protects the rear of the vehicle from dirt both on wet roads and off the road, for example when riding through mud puddles. This keeps the rear light and number plate, but also a mounted topcase and other luggage items protected from dirt for longer.

Original BMW Motorrad equipment is available from your authorised BMW Motorrad dealership.



## MAINTENANCE & TECHNOLOGY

---

### POWER SOCKET



Electronic devices can be connected to the vehicle electrical system via the 12V power socket. One example of this is the BMW USB charger, which can be used to charge and operate mobile phones and MP3 players with an appropriate interface while riding.

To be fitted and/or enabled in a specialist workshop, ideally at your authorised BMW Motorrad dealership.





# ACCESSORIES FOR BMW F 900 R



## STORAGE

### SMALL TOPCASE, 30L

This waterproof plastic topcase with a painted lid and 30-litre volume offers high-quality workmanship and enough space for a helmet.

#### Topcase lid outer shell, asphalt metallic matt (not shown)

Only in conjunction with luggage carrier, topcase carrier and matching outer shell. For information on speed and load limitations, please refer to the instruction booklet. For more detailed information, contact your authorised BMW Motorrad dealership or go online at [bmw-motorrad.com](http://bmw-motorrad.com).

#### 1 Topcase lid outer shell, Black storm metallic



#### 2 Topcase lid outer shell, Light white



#### 3 Topcase lid outer shell, Racing red



### BACKREST PAD FOR SMALL TOPCASE



Thanks to the comfortable backrest pad for the small topcase, the passenger can enjoy improved comfort both on short trips and on long tours.

### LINER FOR TOPCASE



The matching tailored liner for the topcase gets the luggage organised and facilitates loading and unloading. The carry handle and shoulder strap make the bag easy to access and transport. The practical details include the outside pocket and the three-sided zipper.





**SOFT BAG**

The high-quality soft bag made of durable polyester convinces with practical details and a storage volume of 20 litres. Features such as the waterproof liner, the all-round zipper, the carrying handle and the quick-release fastener for easy mounting on the motorcycle ensure a secure hold and practical handling.

The sturdy case holder allows easy and secure installation of the soft case. Even if the case is not mounted, the discreet black holder is hardly noticeable on the bike.

1 Soft bag

NEW

2 Soft bag case holder

NEW



LUGGAGE GRID

NEW

LARGE TANK BAG

NEW

SMALL TANK BAG

NEW



A topcase or other pieces of luggage can be easily and securely attached to the sturdy luggage carrier made of powder-coated die-cast aluminium. Since the luggage carrier is attached to the motorcycle in a vibration-free manner, the riding characteristics improve noticeably with the topcase mounted, especially at higher speeds.

The tank bag, made of durable polyester fabric, offers many intelligent details. Its volume can be extended from 11 to 16 litres as required. Extra space is available in the map pocket and exterior pockets. The smart belt fastener design guarantees a secure hold and extremely functional handling.

The small, durable tank bag with belt attachment is the ideal companion for short trips. The main compartment with removable waterproof liner, the cable duct, the storage space volume of 5.5 litres, the carry handle and the removable shoulder strap are handy qualities that leave almost nothing to be desired.

**ATTACHMENT ELEMENT FOR TANK BAG  
(NOT SHOWN)**

NEW

A BMW Motorrad tank bag can be attached quickly and securely to the vehicle using the model-specific fastening elements. The two-part fastening is mounted at the front and rear of the motorcycle using a strap or screw connection. The tank bag then only needs to be positioned and fastened with buckles.





# DESIGN

## OPTION 719 SILVER MIRRORS



The Option 719 silver-coloured mirrors are made of milled aluminium and highlight the high-quality character of the bike. The low-vibration design and aerodynamic shape ensure excellent visibility. The attractive design also creates a strong individualisation effect.

## ADJUSTABLE RIDER FOOTRESTS

NEW



The rider footrest made of black anodised aluminium combines a dynamic look with ergonomics and sportiness at the highest level. Thanks to the ribbed tread surface and three-step height adjustment, it provides additional support and optimum vehicle control.

## FOLDING CLUTCH AND BRAKE LEVERS

NEW



The handbrake lever can be adjusted in five positions for the preferred grip range and, thanks to the folding mechanism, has a defined folding moment.

The clutch lever can be adjusted in three positions for the preferred grip range and, thanks to the folding mechanism, has a defined folding moment.

To be fitted and/or enabled in a specialist workshop, ideally at your authorised BMW Motorrad dealership.

## CLUTCH LEVER AND HANDBRAKE LEVER PROTECTORS

NEW



The clutch and handbrake lever protectors make a clear statement of uncompromising sportiness on the road. The curved bows made of aluminium and plastic protect the clutch lever and handbrake lever on the handlebars from being unintentionally actuated due to contact with another vehicle or damaging the bike if it falls over.

## ENGINE SPOILER

The elegant three-part engine spoiler made of shatterproof and UV-resistant plastic ensures an individual sporty look. The side parts painted in Granite grey metallic, San Marino blue metallic and Racing red create a striking visual accent.

Expected availability: from Q3/2020.

### 1 Engine spoiler, Granite grey metallic

NEW

### 2 Engine spoiler, San Marino blue metallic

### 3 Engine spoiler, Racing red

NEW



## PASSENGER SEAT COVER

The stylish passenger cover skilfully emphasises the bike's sporty and dynamic look. Made of shatter-proof and UV-resistant plastic, it can be easily installed with cords in a plug-and-play fashion ensuring a sporty single-seater look when riding solo.

### 1 Passenger seat cover, Black storm metallic

NEW

### 2 Passenger seat cover, Hockenheim silver metallic

NEW

### 3 Passenger seat cover, San Marino blue metallic

NEW





# ERGONOMICS & COMFORT

## LOW SEAT

NEW

The low seat makes it easier to get on and off and improves ground accessibility. Many riders feel safer thanks to the reduced seat height, because they can manoeuvre and control their motorcycle more easily. The ergonomics of the low seat are designed for long tours. The high-quality surface material in black corresponds to the standard equipment.



## HIGH SEAT

NEW

The high seat has a seat height of 835 mm thanks to the additional padding. This means that even tall riders enjoy a comfortable knee angle and a relaxed and comfortable seat position that helps prevent signs of fatigue even on long journeys.



## WINDSCREENS

The tinted Pure windscreen as cockpit trim panel underlines the bike's sporty appearance.

The scratch-resistant coated high windscreen is higher and wider than the standard version and therefore offers noticeably improved wind and weather protection as well as greater overall touring comfort. Especially on fast motorway stretches, the high windscreen provides relief for the upper body and provides more relaxed and fatigue-free kilometres.

### 1 Pure windscreen

NEW



### 3 High windscreen

NEW



## CENTRE STAND

NEW

The stable centre stand ensures a safe stand for the motorcycle even on slopes and offers advantages, for example, when refuelling, mounting cases and topcases or checking tyre pressure. The motorcycle also takes up less space when parked upright.



## HANDLEBARS, HIGH

NEW

The high handlebars are 27 mm higher compared to the standard and allow a more upright sitting position. The resulting overall improvement in ergonomics improves the riding experience and reduces signs of fatigue. The rider simply feels safer on the bike.



## LOW-SLUNG (NOT SHOWN)

NEW

The changes in the chassis resulting from the lowered suspension reduce the vehicle height and the seat height. This means that even smaller riders can enjoy improved stability and have better control over their machine when manoeuvring.

## SHIFT ASSISTANT PRO (NOT SHOWN)

The shift assistant Pro allows shifting up and down in almost all load ranges and engine speed ranges without actuating the clutch or throttle. The assistant thus ensures noticeably reduced shifting times, a relief of the clutch hand and thus greater comfort and dynamics.

To be fitted and/or enabled in a specialist workshop, ideally at your authorised BMW Motorrad dealership.

## RETROFIT SET OF HEATED GRIPS AND SWITCHES (NOT SHOWN)

No more cold hands: this is ensured by the electric heated grips with multi-stage control. They increase comfort and at the same time bring more safety, because with warm hands and more feeling in their fingers, the rider simply has better control of the motorcycle - on cold days as well as when riding in the rain.

For more detailed information, contact your authorised BMW Motorrad dealership or go online at [bmw-motorrad.com](http://bmw-motorrad.com). To be fitted and/or enabled in a specialist workshop, ideally at your authorised BMW Motorrad dealership.

## RETROFIT SET FOR CRUISE CONTROL (NOT SHOWN)

NEW

The electronic cruise control can be activated from 30 km/h and keeps the riding speed constant. This makes it possible to enjoy longer motorway stretches in a relaxed style. The function is deactivated on braking, and the selected speed is automatically adopted after activating the Resume button.



# NAVIGATION & COMMUNICATION

## BMW MOTORRAD NAVIGATOR VI

With the multifunctional Navigator VI, route planning becomes child's play. The system with 16 GB flash memory and a five-inch touch screen always shows the right way. Thanks to the circular polarisation filter (CPOL), the waterproof display is easy to read even in direct sunlight. The high-resolution screen in a casing similar to a smartphone provides all the essential information and ensures that you can see the big picture required in every situation. Numerous additional functions make planning and touring an exciting experience. Plan your routes can be created according to your personal preferences and enjoy driving on winding and quiet side roads. In unknown terrain, the "round trip" option is a good choice as it reliably guides the rider at the end of the tour back to the starting point. The Bluetooth connection to the BMW Motorrad communication system and the optional Smartphone Link app enable multimedia on the go: navigation announcements, telephone calls and music streaming as well as the retrieval of weather forecasts or traffic jam information are no problem. Navigation preparation adds further functions such as "My Motorcycle", and the multi-controller on the handlebars offers an alternative control option. Choose the pre-installed map data, and you will always be up to date thanks to lifelong, free map updates.



### Bracket for BMW Motorrad navigation systems (not shown)

Note the differences in national-market versions.  
 Only available in conjunction with OE navigation preparation.  
 Not available in conjunction with the smartphone cradle holder or handlebar extension.  
 To be fitted and/or enabled in a specialist workshop,  
 ideally at your authorised BMW Motorrad dealership.

## BMW MOTORRAD SMARTPHONE CRADLE

BMW Motorrad's robust smartphone cradle provides a safe and protected place for your smartphone. This means that useful functions such as navigation information and online information can also be used while you are on the move. Thanks to the handy charging function, your smartphone is also always ready for action on extended bike tours.

The functional BMW Motorrad smartphone cradle bracket is securely attached to the handlebar clamping block or the handlebar tube. This ensures that it can be positioned in the rider's direct field of vision. In addition, the bracket complements perfectly the cockpit area. The BMW Motorrad Navigator can also be attached to the bracket. (not shown)



Only available in combination with bracket for BMW Motorrad navigation devices.  
 Not available in conjunction with preparation for navigation device or handlebar riser.  
 To be fitted and/or enabled in a specialist workshop,  
 ideally at your authorised BMW Motorrad dealership.

# SAFETY

## RETROFIT SET FOR ANTI-THEFT ALARM SYSTEM (NOT SHOWN) NEW

Strong protection from theft: If the motorcycle is moved or struck violently, the anti-theft alarm system responds with a clearly audible signal and a flashing warning light. The acoustic and optical warning will draw the attention of passers-by quickly. The alarm system is activated automatically when the ignition is switched off.

Note the differences in national-market versions.  
 To be fitted and/or enabled in a specialist workshop,  
 ideally at your authorised BMW Motorrad dealership.

## ABS PRO RETROFIT SET (NOT SHOWN) NEW

To be fitted and/or enabled in a specialist workshop,  
 ideally at your authorised BMW Motorrad dealership.

## PRO RIDING MODES RETROFIT SET (NOT SHOWN) NEW

The Pro riding modes can be retrofitted using an enabling code. Riders without Pro riding modes therefore do not have to do without modern safety features. Retrofitting is possible with the Pro, with DTC or with ABS Pro driving modes is possible.

For more detailed information, contact your authorised BMW Motorrad dealership or go online at [bmw-motorrad.com](http://bmw-motorrad.com).  
 To be fitted and/or enabled in a specialist workshop,  
 ideally at your authorised BMW Motorrad dealership.  
 Only available in conjunction with Dynamic Traction Control (DTC)

## RETROFIT SET FOR TYRE PRESSURE CONTROL (NOT SHOWN)

Tyre Pressure Control (TPC) with all functions can be retrofitted by installing the control unit. TPC provides reliable information about the current tyre pressure and warns the rider about pressure loss at an early stage. The corresponding notifications and instructions are provided by the on-board computer in the cockpit.

To be fitted and/or enabled in a specialist workshop,  
 ideally at your authorised BMW Motorrad dealership.

## PROTECTIVE GLASS FOR 6.5-INCH TFT DISPLAY

The protective glass reliably protects the 6.5-inch TFT display from dirt, flying stones and damage. The tempered glass has an anti-glare and anti-reflective surface, so that it is still easy to read the TFT display. With BMW Motorrad inscription.





## MAINTENANCE & TECHNOLOGY

**OUTPUT REDUCTION** NEW  
**35 kW / 48 HP**  
**(NOT SHOWN)**

The power reduction retrofit to 35 kW (48 hp) is an attractive option for beginners and returning riders. This leaves nothing to be desired when it comes to riding pleasure and feeling. The engine can be brought back to its full power later on, if desired. The power reduction is carried out by means of an enabling code.





# ACCESSORIES FOR BMW S 1000 R



## HP PARTS

### HP RIDER FOOTREST SYSTEM AND HP PASSENGER FOOTRESTS

The HP rider footrest system is adjustable in many ways and offers ergonomic qualities as well as maximum variability. The high-quality milled parts made of anodised aluminium can be adapted to a sporty riding style or different rider statures and thus ensure even better control, for example in an inclined position.

The HP passenger footrests are milled from an anodised aluminium alloy and give the bike an even sportier appearance.

To be fitted and/or enabled in a specialist workshop, ideally at your authorised BMW Motorrad dealership.

#### 1 HP rider footrests



#### 2 HP passenger footrests



#### 3 HP passenger footrests, black



### PRO GEAR-SHIFT ASSIST

Delivers smooth acceleration without using the clutch lever – 10 times faster than normal gear shifts.

To be fitted and/or enabled in a specialist workshop, ideally at your authorised BMW Motorrad dealership.

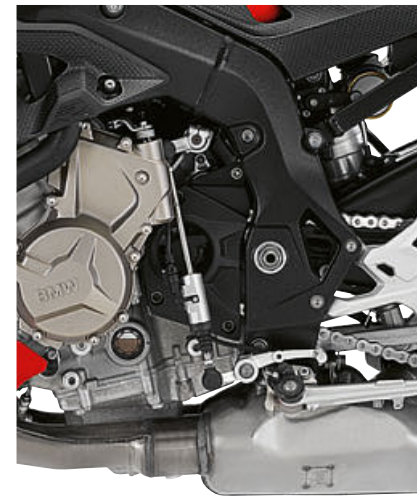

### HP FORGED WHEELS

The black anodised HP forged front wheel offers improved handling and suspension characteristics thanks to its weight advantage. It weighs around 2 kg less than the standard wheel, which is particularly noticeable in fast S-bends.

The black anodised HP forged rear wheel is lighter than the standard wheel while maintaining optimum stability. The lower mass promotes the responsiveness of the spring strut and noticeably improves the handling characteristics.

To be fitted and/or enabled in a specialist workshop, ideally at your authorised BMW Motorrad dealership.

#### 1 HP forged wheel, front



#### 2 HP forged wheel, rear



### HP ENGINE PROTECTORS

Aluminium engine protectors with plastic sliders provide additional protection for your engine.

To be fitted and/or enabled in a specialist workshop, ideally at your authorised BMW Motorrad dealership.

#### 1 HP engine guard, left



#### 2 HP engine guard, right



### HP CLUTCH LEVER PROTECTOR / HP CLUTCH LEVER PROTECTOR

These lever guards are essential on the racetrack and show the bike's racing pedigree on public roads.

HP clutch lever protector only available in conjunction with HP clutch lever.





**HP AXLE PROTECTORS**

The HP axle protectors made of highly abrasion-resistant plastic protect the fork and swinging arm from scratches if the bike falls or tips over.

Mounting instructions are available from your authorised BMW Motorrad dealership.

**FOLDING HP CLUTCH LEVER / HP BRAKE LEVER**

Made out of corrosion-resistant, anodized aluminium, the CNC-milled HP brake and clutch levers are both stylish and highly practical. Easily adjustable to provide the most suitable position for every rider, the built-in folding design also reduces the risk of bending or breaking in the event of an accident.

To be fitted and/or enabled in a specialist workshop, ideally at your authorised BMW Motorrad dealership.

1 Folding HP brake lever

2 Folding HP clutch lever



**HP CARBON BOLT-ON PARTS**

Superlative performance is a given with these bolt-on parts. They're elegant, exclusive and durable – each one a masterpiece in its own right. And if perfection's what you're after, you've hit the jackpot here because they're made of carbon, the ultimate lightweight material. An unbeatable combination of stylish looks and technical expertise.

Mounting instructions are available from your authorised BMW Motorrad Retailer.

6 Model shown: BMW S 1000 XR

1 HP carbon rear mudguard

2 HP carbon front mudguard

3 HP carbon tank cover



4 HP carbon airbox cover

5 HP carbon sprocket cover

6 HP carbon chain guard





**HP COVER KIT**

The HP cover kit offers covers in place of the mirrors, turn indicators and licence plate holder removed during racetrack use.

Only for track use (not homologated for road use).



**HP CARBON WINDSCREEN**

The high-quality HP carbon windscreen signals sportiness with its look. It is coated with UV-resistant high-gloss paintwork and is therefore particularly impact-proof. The high-quality carbon design also makes the windscreen very light and thus reduces the overall weight of the motorbike.



**ENGINE SPOILER HEAT PROTECTION SHIELD (NOT SHOWN)**

The heat protection shield for the engine spoilers on both sides prevents thermal damage due to the titanium exhaust system.

For simultaneous fitting of engine spoiler and HP titanium exhaust system.

**USEFUL GEAR (ON AND OFF THE TRACK)**

**1 HP tyre heaters**



**2 HP chain tensioner**



**3 HP rider's seat**



**4 HP assembly stand mounting**



**STORAGE**

**REAR BAG**



The robust rear bag with its waterproof main compartment and water-repellent outer pockets offers a volume from 25 to 32 litres. A padded carry handle and a shoulder strap make transport easy. The bag is perfectly adapted to the passenger seat and is securely fastened with 3-point tension straps.

Not available in conjunction with the comfort passenger seat or passenger seat cover. For information on speed and load limitations, please refer to the instruction booklet.

**TANK BAG**



The tank bag is made of durable PU-coated polyester fabric with a waterproof main compartment and strap fastening and holds 13 litres. The water-repellent outside pocket offers additional stowage space. The carry handle and the detachable shoulder strap are further practical features.

For information on speed and load limitations, please refer to the instruction booklet.

**SADDLE BAGS**



The saddlebags made of durable polyester offer around 10 litres of stowage space on each side, which can be expanded up to 16 litres. The three-sided all-round zip ensure good accessibility. The scope of supply includes two waterproof, removable liners. The Quick-Lock system enables quick installation.

For information on speed and load limitations, please refer to the instruction booklet.

**BAG FOR PASSENGER SEAT**



The waterproof passenger seat bag made of durable polyester with 2.5 litre stowage space can be expanded to 5.5 litres – just the right size for a day trip. The three-sided all-round zip ensure good accessibility.

Not available in conjunction with the passenger seat cover. For information on speed and load limitations, please refer to the instruction booklet.





# DESIGN

## LED INDICATORS

A shining example: The beautifully designed LED indicators with white turn indicator glass convince with their slim design and modern lighting technology. They respond much faster than incandescent lamps and are virtually wear-free. This provides a clear safety advantage in road traffic.

Note the differences in national-market versions. To be fitted and/or enabled in a specialist workshop, ideally at your authorised BMW Motorrad dealership.



## PLASTIC ENGINE SPOILER IN BIKE COLOUR

Emphasizes the striking design of the BMW S 1000 R and gives it an even sportier look.

Available in Light white, Black storm metallic and Racing red.

To be fitted and/or enabled in a specialist workshop, ideally at your authorised BMW Motorrad dealership.

1 Engine spoiler in Black storm metallic



2 Engine spoiler in Light white



5 Engine spoiler in Racing red



## PLASTIC SEAT HUMP COVER

An absolute must for solo riders is the seat hump cover, which is mounted on the passenger seat. The cover with a black backrest pad emphasises the sporty claim and perfectly complements the Superbike appearance of the bike.

Available in Light white, Black storm metallic and Racing red (not shown).

Not available in conjunction with the rear bag or passenger seat bag.



# ERGONOMICS & COMFORT

## COMFORT SEAT AND COMFORT PASSENGER SEAT

Wider than the standard version, the striking padded comfort seat is perfect for longer tours.

The passenger comfort seat is padded and wider than the standard version, and significantly increases passenger comfort.

**Comfort seat**  
Seat height 840 mm  
Step length 1,865 mm

**2**  
Not available in conjunction with the rear bag.

1 Comfort seat



2 Comfort rear seat



## HEATED GRIPS AND SWITCHES (NOT SHOWN)

Keep your hands warm in cooler temperatures with heated grips (adjustable between two settings). Also available as an equipment option.

To be fitted and/or enabled in a specialist workshop, ideally at your authorised BMW Motorrad dealership.

## PRO GEAR-SHIFT ASSIST (NOT SHOWN)

The shift assistant Pro allows shifting up and down in almost all load ranges and engine speed ranges without clutch control. The assistant thus ensures noticeably reduced shifting times, a relief of the clutch hand and thus more comfort, dynamics and riding pleasure.

To be fitted and/or enabled in a specialist workshop, ideally at your authorised BMW Motorrad dealership.

## SPORT WINDSCREEN, TINTED

The sport windscreen comes with a scratch-resistant coating and provides perfect protection against wind and rain.

Note the differences in national-market versions. To be fitted and/or enabled in a specialist workshop, ideally at your authorised BMW Motorrad dealership.



## PRO RIDING MODES RETROFIT SET (NOT SHOWN)

The Pro riding modes can be retrofitted using an enabling code. Riders without Pro riding modes therefore do not have to do without modern safety features. Retrofitting is possible with the Pro riding modes including Dynamic Traction Control (DTC) or the Pro driving modes including curve-compatible ABS Pro.

For more detailed information, contact your authorised BMW Motorrad dealership or go online at [bmw-motorrad.com](http://bmw-motorrad.com). To be fitted and/or enabled in a specialist workshop, ideally at your authorised BMW Motorrad dealership. Only available in conjunction with Dynamic Traction Control (DTC).



# NAVIGATION & COMMUNICATION

## BMW MOTORRAD NAVIGATOR VI

With the multifunctional Navigator VI, route planning becomes child's play. The system with 16 GB flash memory and a five-inch touch screen always shows the right way. Thanks to the circular polarisation filter (CPOL), the waterproof display is easy to read even in direct sunlight. The high-resolution screen in a casing similar to a smartphone provides all the essential information and ensures that you can see the big picture required in every situation. Numerous additional functions make planning and touring an exciting experience. Plan your routes can be created according to your personal preferences and enjoy driving on winding and quiet side roads. In unknown terrain, the "round trip" option is a good choice as it reliably guides the rider at the end of the tour back to the starting point. The Bluetooth connection to the BMW Motorrad communication system and the optional Smartphone Link app enable multimedia on the go: navigation announcements, telephone calls and music streaming as well as the retrieval of weather forecasts or traffic jam information are no problem. Navigation preparation adds further functions such as "My Motorcycle", and the multi-controller on the handlebars offers an alternative control option. Choose the pre-installed map data, and you will always be up to date thanks to lifelong, free map updates.

Note the differences in national-market versions.  
Only available in conjunction with OE navigation preparation.



## BMW MOTORRAD SMARTPHONE CRADLE

BMW Motorrad's robust smartphone cradle provides a safe and protected place for your smartphone. This means that useful functions such as navigation information and online information can also be used while you are on the move. Thanks to the handy charging function, your smartphone is also always ready for action on extended bike tours.

Only in combination with bracket for BMW Motorrad navigation systems.



# SAFETY

## ANTI-THEFT ALARM SYSTEM RETROFIT SET (NOT SHOWN)

If the anti-theft alarm system is moved or struck violently, the system responds with a clearly audible signal and a flashing warning light.

Note the differences in national-market versions.  
To be fitted and/or enabled in a specialist workshop,  
ideally at your authorised BMW Motorrad dealership.

## ACTIVATION CODE FOR DTC (NOT SHOWN)

DTC (Dynamic Traction Control) ensures greater riding stability and controls wheel slip even when leaning into corners to prevent the rear wheel from spinning. Depending on the riding mode, DTC allows more or less slip and thus guarantees the maximum safety and riding dynamics on different routes.

To be fitted and/or enabled in a specialist workshop,  
ideally at your authorised BMW Motorrad dealership.

## ABS PRO RETROFIT SET (NOT SHOWN)

For more detailed information, contact your authorised BMW Motorrad dealership or go online at [bmw-motorrad.com](http://bmw-motorrad.com).  
Only available in conjunction with Dynamic Traction Control (DTC).  
To be fitted and/or enabled in a specialist workshop,  
ideally at your authorised BMW Motorrad dealership.



Original BMW Motorrad equipment is available from your authorised BMW Motorrad dealership.



# ACCESSORIES FOR THE BMW R 1250 R



## HP PARTS

### HP SPORT SILENCER



The titanium-clad HP sport silencer delivers an impressively rich sound and is a clear avowal to racing, both visually and acoustically. The high-quality slip-on model offers a weight saving of approx. 0.8 kg compared to the standard model thanks to its lightweight design.

### HP HAND LEVER, ADJUSTABLE



The CNC-milled HP hand levers made of anodised aluminium combine functionality and aesthetics. The grip width can be adjusted in five steps (brake lever) or three steps (clutch lever) using a setting screw and thus adapted to individual requirements. The look with HP logo also emphasises the bike's sportiness.

### HP COVERS FOR EXPANSION TANKS



The HP cover for expansion tanks made of anodised aluminium also adds to the bike's sporty character. The high-quality milled cover with HP branding emphasises the high-performance claim and also provides for an attractive customisation of the bike.

### HP MIRRORS



The high-quality HP mirrors are made of milled aluminium and emphasise the sporty character of the bike. The low-vibration construction and aerodynamic shape ensure excellent visibility. The attractive design with BMW Motorrad inscription also creates a strong individualisation effect.

### HP ENGINE HOUSING COVER, FRONT



The HP engine housing cover made of anodised aluminium also adds to the bike's sporty character. The high-quality milled cover and HP branding emphasise the high-performance standard and also guarantee an attractive customisation of the bike.

### ADJUSTABLE HP RIDER FOOTRESTS / HP FOOT LEVER



The HP rider footrests are adjustable in three positions and offer a high level of comfort in addition to ergonomic qualities. The high-quality milled parts made of anodised aluminium can be adapted to a sporty riding style or different rider statures and thus ensure even better control, for example in an inclined position.

The milled HP foot levers made of anodised aluminium are adjustable and come in sporty black/blue/silver. Adjusted to match, the foot levers can also be operated better and more sensitively when riding on large inclines. The exclusive look with HP logo also emphasises the bike's performance-based character.



HP CYLINDER HEAD COVERS



The HP cylinder head covers made of anodised aluminium give the boxer engine an attractive appearance. The high-quality milled covers and HP branding highlight the motorcycle's sporty character. The HP oil filler plug perfectly matches the cylinder head covers.

HP CARBON HEAT GUARD



The high-quality HP Carbon cover acts as a heat protection and at the same time emphasises the sporty look of the sport silencer. The lightweight CFRP component for vehicles with and without a centre stand is sealed with UV-resistant high-gloss paint and adds a further sporty nuance.



# STORAGE

TOURING CASES

With a volume of 32 litres, the high-quality hard shell touring case for installation on the left offers ample space for luggage or the motorcycle helmet. The splashproof case with painted lid can be locked and is the perfect travel companion for short or longer tours.

With a volume of 31 litres, the high-quality hard shell touring case for installation on the right offers ample space for luggage. The splashproof case with painted lid can be locked and is the perfect travel companion for short or longer tours.

For information on speed and load restrictions, please refer to the instruction booklet.

1 Touring case, Asphalt grey metallic matt



2 Touring case, Black storm metallic



3 Touring case, Granite grey metallic matt



4 Touring case, Light white



Original BMW Motorrad equipment is available from your authorised BMW Motorrad dealership.



CASE RACK



The touring case can be easily and securely attached to the sturdy black powder-coated steel case rack.

LINER FOR TOURING CASES



These practical, water-resistant liners make full use of the capacity of the touring cases. Luggage can be accessed easily with one hand, and the bag can even be worn over the shoulder thanks to a detachable strap.

BAG FOR FRAME



The lined pocket made of PVC-coated polyester fabric is attached to the frame below the rider's seat and does not restrict freedom of movement. Now smaller items are also always on board while on the road. The water-repellent zip fastener with non-slip zipper allows quick access.

LINER FOR TOPCASE



Makes loading and unloading a topcase even easier. The liner comes with a practical carry handle and can be folded flat when not in use.

LINER FOR TOPCASE



The sturdy, stylish luggage carrier is ideal for reliably securing the topcase or other large items of luggage. It acts as a full grip for the passenger and is also ideal for use as a pushing aid when manoeuvring.

TANK BAG SMALL, 5-9 L



The small tank bag made of durable PU-coated polyester fabric is the ideal companion for short trips. The waterproof main compartment with liner, the exterior pocket, the volume that can be expanded from 5 to 9 litres, the carry handle and the removable shoulder strap are functional features that meet all your everyday needs.

SMALL TOPCASE, 30 L

The waterproof plastic topcase offers enough space for a helmet with a volume of 30 litres. The lid, which is available in Asphalt Grey metallic matt, Black Storm metallic or Light White, and the soft-close hinges, which allow the lid to be lowered gently, underline the high-quality appeal.

Only available in conjunction with luggage carrier, topcase carrier and matching outer shell. For information on speed and load limitations, please refer to the instruction booklet. For more detailed information, contact your authorised BMW Motorrad dealership or go online at [bmw-motorrad.com](http://bmw-motorrad.com).

BAG FOR PASSENGER SEAT, 16 L

With a volume of 16 litres, this durable bag for the passenger seat offers enough storage space for the daily ride to work or for day trips. The three-sided zip fastener allows quick access, while the functional carrying handle facilitates transport.

1 Topcase, Asphalt grey metallic matt



2 Topcase, in Black storm metallic



3 Topcase, Light white





# DESIGN

## OPTION 719 CLASSIC WHEEL

The high-quality Option 719 Classic wheel comes in an attractive bicolour look with elaborate contrast milling. The special workmanship of the cast wheel surface gives the machine an exclusive, high-quality character.

### 1 Option 719 Classic front wheel



### 2 Option 719 Classic rear wheel



## OPTION 719 SPORT WHEEL

The high-quality Option 719 Sport wheel comes in an attractive bicolour look with elaborate contrast milling. The special workmanship of the cast wheel surface gives the machine an exclusive, high-quality character.

### 1 Option 719 Sport front wheel



### 3 Option 719 Sport rear wheel



## REAR-WHEEL COVER



The milled aluminium rear-wheel cover emphasises the dynamic design of the bike. The black anodised covers with BMW Motorrad inscription and a diameter of 62 mm enhance the motorcycle visually and technically.

## LED INDICATORS



A shining example: the elegant LED indicators with white indicator glass match the motorcycle's look and also enhance it. Moreover, they impress with their sleek design and modern lighting technology. For example, they respond faster than classic bulbs and are virtually wear-free.

Note the differences in national-market versions.  
To be fitted and/or enabled in a specialist workshop, ideally at your authorised BMW Motorrad dealership.

## OPTION 719 CLASSIC COVERS FOR EXPANSION TANKS



The Option 719 Classic covers for expansion tanks set an elegant, design highlight with their silver-coloured appearance. The milled cover made of anodised aluminium bears the inscription "Option 719". Together with the other special parts of Option 719 an exclusive customisation effect is created.

To be fitted and/or enabled in a specialist workshop, ideally at your authorised BMW Motorrad dealership.

## OPTION 719 CLASSIC HAND LEVERS, ADJUSTABLE

The Classic hand levers of the exclusive Option 719 are milled from an anodised aluminium alloy. The grip width can be adjusted in five steps (brake lever) or three steps (clutch lever) using a setting screw and thus adapted to individual requirements. The high-quality Billet Pack parts with Option 719 branding add value to the bike.

To be fitted and/or enabled in a specialist workshop, ideally at your authorised BMW Motorrad dealership.



## OPTION 719 CLASSIC ENGINE HOUSING COVER, FRONT

The Option 719 Classic engine housing cover sets an elegant, design highlight with its silver-coloured look. The high-quality milled cover made of anodised aluminium bears the "Option 719" inscription. Together with the other special parts of Option 719 an exclusive customisation effect is created.

To be fitted and/or enabled in a specialist workshop, ideally at your authorised BMW Motorrad dealership.





**OPTION 719 CLASSIC ADJUSTABLE RIDER FOOTREST / FOOT LEVER**

The Classic aluminium rider footrests are adjustable in three positions and offer a high level of comfort in addition to ergonomic qualities. The high-quality milled parts of the exclusive Option 719 can be adapted to a sporty riding style or different rider statures and thus ensure even better control, for example in an inclined position.

The exclusive Option 719 Classic milled aluminium foot levers are adjustable and emphasise the classic, high-quality character of the motorcycle. Adjusted to match, the foot levers can also be operated more sensitively when riding on large inclines. The high-quality Billet Pack parts with Option 719 branding add value to the bike.



**OPTION 719 SILVER MIRRORS**

The Option 719 silver-coloured mirrors are made of milled aluminium and highlight the high-quality character of the bike. The low-vibration construction and aerodynamic shape ensure excellent visibility. The attractive design also creates a strong individualisation effect.



**OPTION 719 CLASSIC CYLINDER HEAD COVERS**



The Classic cylinder head covers of the exclusive Option 719 add design highlights with their silver-coloured appearance. The high-quality milled covers made of anodised aluminium bring the boxer engine into the spotlight. The exclusive special parts bear the inscription Option 719 and emphasise the high-quality character of the bike.

To be fitted and/or enabled in a specialist workshop, ideally at your authorised BMW Motorrad dealership.

**OPTION 719 CLASSIC OIL FILLER PLUG**



To be fitted and/or enabled in a specialist workshop, ideally at your authorised BMW Motorrad dealership.

**CHROME-PLATED EXHAUST MANIFOLD**



The chrome-plated exhaust manifold further enhances the motorcycle's appearance. This elegant manifold can be combined with the standard silencer or the HP sport silencer.

To be fitted and/or enabled in a specialist workshop, ideally at your authorised BMW Motorrad dealership.





# ERGONOMICS & COMFORT

## RIDER AND PASSENGER SEATS

30mm lower than the standard version, this black rider's seat makes climbing on and off easier and keeps the ground within easy reach. This makes the motorcycle easier to manoeuvre and control.

The rider's seat in classic black has a seat height of 790mm and an inner leg curve of 1,780mm.

The 30mm higher rider's seat in black is particularly suitable for tall riders. The comfortable knee angle provides the biker with a noticeable improvement in seating comfort and thus even more carefree kilometres, particularly over long distances

The Sport rider seat in black is higher and narrower than the standard seat and supports a sporty riding style thanks to its active seat position.

Thanks to a broader seat area and additional padding, the Comfort passenger seat provides noticeably greater seating comfort.

1 Low rider seat, black



2 Rider seat, black



3 High rider's seat, black



4 Sport rider seat, black



5 Comfort passenger seat, black



6 Passenger seat, black

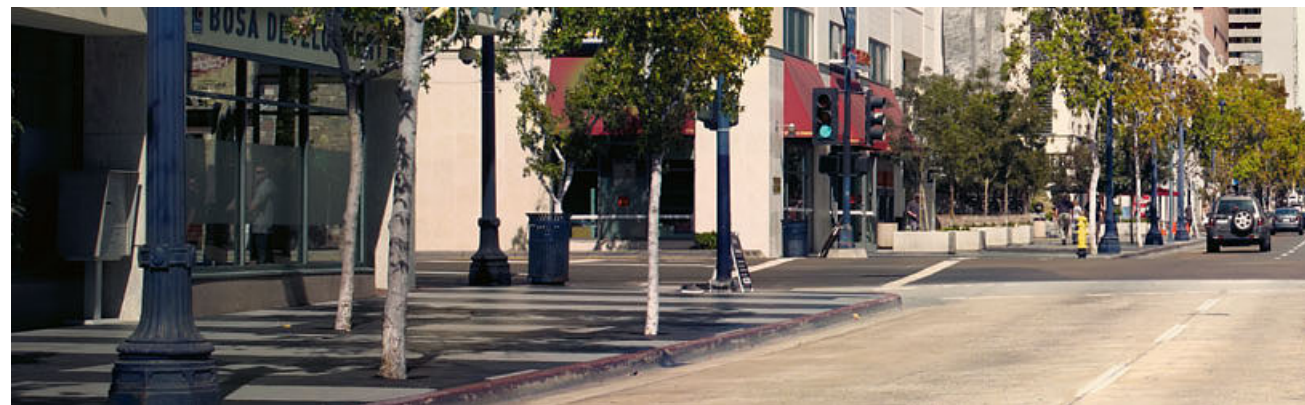

## WINDSCREENS

The clear Sport windscreen with a scratch-resistant coating noticeably relieves the wind pressure on the upper body and adds a further sporty nuance. The classic roadster look remains intact yet even fast motorway stretches or longer tours can be enjoyed with even greater relaxation.

The tinted Sport windscreen with a scratch-resistant coating noticeably relieves the wind pressure on the upper body and adds a sporty nuance. The classic roadster look remains intact yet even fast motorway stretches or longer tours can be enjoyed with even greater relaxation.

The high windscreen is approx. 80mm higher and 45mm wider than the Sport windscreen and therefore offers noticeably improved wind and weather protection as well as greater overall touring comfort. The scratch-resistant coating guarantees lasting transparency, while the clear look emphasises the high-quality appearance.

1 Sport windscreen



2 Sport windscreen, tinted



3 High windscreen



4 Holder for windscreen



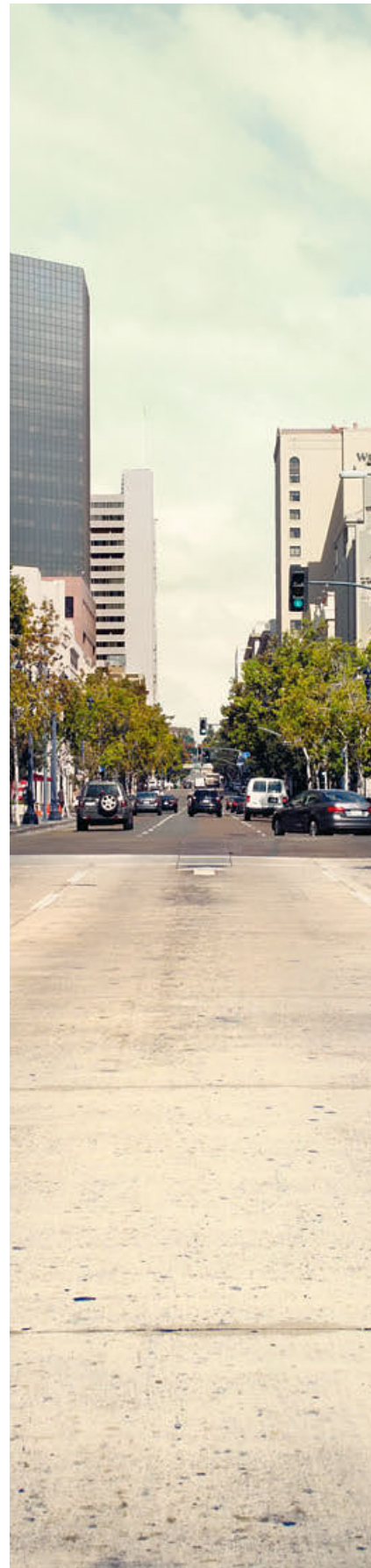

**CENTRE STAND**

The stable centre stand ensures a safe stand for the motorcycle even on slopes and offers advantages, for example, when refuelling, mounting cases and topcases or checking tyre pressure. The motorcycle also takes up less space when parked upright.

**PRO GEAR-SHIFT ASSIST**

The shift assistant Pro allows shifting up and down in almost all load ranges and engine speed ranges without actuating the clutch or throttle. The assistant thus ensures noticeably reduced shifting times, a relief of the clutch hand and thus greater comfort and dynamics.

**ENDURO FOOTREST**

The wider and longer stainless steel Enduro footrest offers more grip and allows better off-road vehicle control.

To be fitted and/or enabled in a specialist workshop, ideally at your authorised BMW Motorrad dealership.

**SPORTS HANDLEBARS (NOT SHOWN)**

To be fitted and/or enabled in a specialist workshop, ideally at your authorised BMW Motorrad dealership.

**HEATED GRIPS AND SWITCHES (NOT SHOWN)**

Warm hands feel good, which is why these heated handlebar grips have two settings designed to keep hands and fingers pleasantly warm.

To be fitted and/or enabled in a specialist workshop, ideally at your authorised BMW Motorrad dealership.

**PRO RIDING MODES RETROFIT SET (NOT SHOWN)**

The Pro riding modes can be retrofitted using an enabling code. Riders of older motorcycles therefore do not have to do without modern safety features. Depending on the year of manufacture, retrofitting is possible with the Pro, Pro with DTC or Pro with ABS Pro, DTC and HSC modes.

To be fitted and/or enabled in a specialist workshop, ideally at your authorised BMW Motorrad dealership.

**TYRE PRESSURE CONTROL RETROFIT SET (NOT SHOWN)**

The electronic cruise control can be activated from 30 km/h and keeps the riding speed constant. This makes it possible to enjoy longer motorway stretches in a relaxed style. The function is deactivated on braking, and the selected speed is automatically adopted after activating the Resume button.

To be fitted and/or enabled in a specialist workshop, ideally at your authorised BMW Motorrad dealership.

**RETROFIT SET FOR HILL START CONTROL (NOT SHOWN)**

Stopping and starting on a slope – with Hill Start Control this is not a problem, even with a passenger and a fully loaded motorcycle. Also available as optional equipment.

To be fitted and/or enabled in a specialist workshop, ideally at your authorised BMW Motorrad dealership.

## NAVIGATION & COMMUNICATION

**BMW MOTORRAD NAVIGATOR VI**

With the multifunctional Navigator VI, route planning becomes child's play. The system with 16 GB flash memory and a five-inch touch screen always shows the right way. Thanks to the circular polarisation filter (CPOL), the waterproof display is easy to read even in direct sunlight. The high-resolution screen in a casing similar to a smartphone provides all the essential information and ensures that you can see the big picture required in every situation. Numerous additional functions make planning and touring an exciting experience. Plan your routes can be created according to your personal preferences and enjoy driving on winding and quiet side roads. In unknown terrain, the "round trip" option is a good choice as it reliably guides the rider at the end of the tour back to the starting point. The Bluetooth connection to the BMW Motorrad communication system and the optional Smartphone Link app enable multimedia on the go: navigation announcements, telephone calls and music streaming as well as the retrieval of weather forecasts or traffic jam information are no problem. Navigation preparation adds further functions such as "My Motorcycle", and the multi-controller on the handlebars offers an alternative control option. Choose the pre-installed map data, and you will always be up to date thanks to lifelong, free map updates.

**Retrofit set for preparation for navigation device (not shown)**

Note the differences in national-market versions. Only available in conjunction with OE navigation preparation.





## SAFETY

### LED AUXILIARY HEADLIGHTS

The powerful LED additional headlights extend the illumination to ensure the required vision in poor visibility conditions. Thus they perfectly complement the main headlight. LED technology ensures virtually wear-free operation.

To be fitted and/or enabled in a specialist workshop, ideally at your authorised BMW Motorrad dealership. The additional headlights are approved for use as fog lights, and may only be used in poor weather conditions. Country-specific road traffic regulations apply.



### SAFETY SCREW FOR OIL FILLER NECK

The safety screw for the oil filler neck is locked using a special Allen® key, preventing theft of the cover. At the same time, unauthorised access and contamination of the oil by foreign substances is prevented. The high-quality aluminium lock has a BMW Boxer inscription.

Safety screw for oil filler neck, black (not shown)



### ENGINE PROTECTION BAR

The robust engine protection bar, made of polished stainless steel, reliably protects the cylinder area against damage without restricting the rider's freedom to lean the machine. The robust tube construction will even take hard knocks and prevent major fall damage off-road and on asphalt.



### PROTECTIVE GLASS FOR 6.5-INCH TFT DISPLAY

The protective glass reliably protects the 6.5-inch TFT display from dirt, flying stones and damage. The tempered glass has an anti-glare and anti-reflective surface, so that it is still easy to read the TFT display. With BMW Motorrad inscription.



### RETROFIT SET ANTI-THEFT ALARM SYSTEM (NOT SHOWN)

NEW

If the motorcycle is moved or struck violently, the system responds with a clearly audible signal and a flashing warning light.

Note the differences in national-market versions. To be fitted and/or enabled in a specialist workshop, ideally at your authorised BMW Motorrad dealership.

### ABS PRO RETROFIT SET (NOT SHOWN)

To be fitted and/or enabled in a specialist workshop, ideally at your authorised BMW Motorrad dealership.

### ANTI-THEFT ALARM SYSTEM RETROFIT SET (NOT SHOWN)

Tyre Pressure Control (TPC) with all functions can be retrofitted by installing the control unit. TPC provides reliable information about the current tyre pressure and warns the rider about pressure loss at an early stage. The corresponding notifications and instructions are provided by the on-board computer in the cockpit.

To be fitted and/or enabled in a specialist workshop, ideally at your authorised BMW Motorrad dealership.

### DAYTIME RUNNING LIGHT RETROFIT SET (NOT SHOWN)

## MAINTENANCE & TECHNOLOGY

### POWER SOCKET

Electronic devices can be connected to the vehicle electrical system via the 12V power socket. One example of this is the BMW USB charger, which can be used to charge and operate mobile phones and MP3 players with an appropriate interface while riding.

To be fitted and/or enabled in a specialist workshop, ideally at your authorised BMW Motorrad dealership.





# ADVENTURE

G 310 GS	192	F 900 XR	242
F 750 GS	200	S 1000 XR	252
F 850 GS	214	R 1250 GS	262
F 850 GS ADVENTURE	230	R 1250 GS ADVENTURE	284

**WHATEVER HAPPENS:  
KEEP RIDING.**

THERE ARE NO WRONG WAYS.  
ONLY DETOURS.





# ACCESSORIES FOR BMW G 310 GS



## STORAGE

### SMALL TOPCASE, 30 L

The waterproof plastic topcase offers enough space for a helmet with a volume of 30 litres. The lid, which is available in Black storm metallic, Light white or Racing red, and the soft-close hinges, which allow the lid to be lowered gently, underline the high-quality appeal.

Only available in conjunction with luggage carrier, topcase carrier and matching outer shell.  
For information on speed and load limitations, please refer to the instruction booklet.  
For more detailed information, contact your authorised BMW Motorrad dealership or go online at [bmw-motorrad.com](http://bmw-motorrad.com).

1 Black storm metallic



2 Light white



2 Racing red



### LIGHT TOPCASE, 29 L



With a volume of 29 litres, the light topcase offers enough space for a helmet and convinces in everyday life as well as on short tours. The black plastic topcase is lockable, has a large reflector on the rear side and a BMW badge on the lid. The maximum payload is 3 kg.

Only available in conjunction with luggage grid.  
For information on speed and load restrictions, please refer to the instruction booklet.

### LINER FOR TOPCASE



Makes loading and unloading a topcase even easier. The liner comes with a practical carry handle and can be folded flat when not in use.

### TANK BAG, 13-20 L



The tank bag made of durable polyester offers many clever details and can be extended from 13 to 20 litres as required. Extra space is available in the map pocket and two exterior pockets. The smart fastener design guarantees a secure hold and extremely practical handling.





# DESIGN

## DECORATIVE STICKER SET

The decorative "Wild" sticker set is perfectly tailored to the motorcycle and creates an attractive, unique look. High-contrast stripes in black and white run across the entire vehicle, creating a striking image reminiscent of a tiger. In addition, the rim rings of contrasting colour ensure attention.

The decorative G310 GS sticker set is perfectly tailored to the motorcycle and creates an attractive, unique look. Apart from the lines in white, blue and yellow, which accentuate the angular design of the motorcycle, rim rings of contrasting colour attract a lot of attention.

1 Decorative WILD sticker set



2 GS decorative sticker set



## LED INDICATORS



A shining example: The beautifully designed LED indicators with white turn indicator glass convince with their slim design and modern lighting technology. They respond much faster than incandescent lamps and are virtually wear-free. This provides a clear safety advantage in road traffic.

Note the differences in national-market versions. To be fitted and/or enabled in a specialist workshop, ideally at your authorised BMW Motorrad dealership.



# ERGONOMICS & COMFORT

## HIGH SEAT



With a seat height of 850 mm, the high seat offers even tall riders a very high level of seating and riding comfort, thus also preventing signs of fatigue.

**High seat**  
Seat height 850 mm

## LOW SEAT



15 mm lower than the standard version, this low seat makes climbing on off easier and keeps the ground within easy reach.

**Low seat**  
Seat height 820 mm

## ADJUSTABLE HANDBRAKE LEVER / CLUTCH LEVER

The ergonomically optimised handbrake and clutch levers can be adjusted in four steps making it easy to attain the preferred grip width. The two-tone look with black powder coating and a chrome-plated adjustment wheel emphasises the individuality of the motorcycle.

1 Adjustable handbrake lever



2 Adjustable clutch lever



## SPORT WINDSCREEN, BLACK (NOT SHOWN)

The black-coloured sport windscreen noticeably relieves the wind pressure on the upper body and gives the machine an extra touch of sportiness. This makes it possible to cover stretches even at high speed in a more relaxed manner.

## HEATED GRIPS AND SWITCHES

The three-stage adjustable heated grips keep hands and fingers comfortably warm even on cold days.

For more detailed information, contact your authorised BMW Motorrad dealership or go online at [bmw-motorrad.com](http://bmw-motorrad.com). To be fitted and/or enabled in a specialist workshop, ideally at your authorised BMW Motorrad dealership.



Original BMW Motorrad equipment is available from your authorised BMW Motorrad dealership.



# NAVIGATION & COMMUNICATION

## BMW MOTORRAD NAVIGATOR VI (INCL. 4-BUTTON CRADLE MOUNT)

With the multifunctional Navigator VI, route planning becomes child's play. The system with 16 GB flash memory and a five-inch touch screen always shows the right way, and the waterproof display is easy to read even in direct sunlight. The high-resolution screen provides all the essential information and ensures that you can see the big picture required in every situation. Numerous additional functions make planning and touring an exciting experience. Plan your routes can be created according to your personal preferences and enjoy driving on winding and quiet side roads. In unknown terrain, the "round trip" option is a good choice as it reliably guides the rider at the end of the tour back to the starting point. The Bluetooth connection to the BMW Motorrad communication system and the optional Smartphone Link app enable multimedia on the go: navigation announcements, telephone calls and music streaming as well as the retrieval of weather forecasts or traffic jam information are no problem. Operation is via the stable Mount Cradle; the four buttons can also be accurately controlled while wearing gloves. Choose the pre-installed map data, and you will always be up to date thanks to lifelong, free map updates.



Only in combination with bracket for navigation systems.  
Note the differences in national-market versions.

## BMW MOTORRAD SMARTPHONE CRADLE

BMW Motorrad's robust smartphone cradle provides a safe and protected place for your smartphone. This means that useful functions such as navigation information and online information can also be used while you are on the move. Thanks to the handy charging function, your smartphone is also always ready for action on extended bike tours.



Only in combination with bracket for BMW Motorrad navigation systems.

# SAFETY

## HAND PROTECTORS



The hand protector, made of impact-resistant and UV-resistant plastic, also protects the operating elements against branches and stone chips while riding off-road, and is aerodynamically tailored to the vehicle. On the road, the wind and weather protection offered by the protectors is also impressive: hands and fingers stay longer dry and warm even at low temperatures.

## ENGINE PROTECTION BAR



The stainless steel engine protection bars protect the bike without compromising the lean angle.

Both the combination with the standard engine spoiler and with the aluminium bash plate is possible.

## SPRAY GUARD COVER (NOT SHOWN)

The rear-wheel cover with splash protection protects the rear of the vehicle from dirt both on wet roads and off the road, for example when riding through mud puddles. This keeps the rear light and number plate, but also a mounted topcase and other luggage items protected from dirt longer.

## ALUMINIUM BASH PLATE

The robust and lightweight aluminium engine guard effectively protects the lower area of the motorcycle against stone chips and damage, such as when bottoming out. It is wider and longer than the standard engine guard. Its elegant design emphasises the high-quality character of the bike.





## MAINTENANCE & TECHNOLOGY

---

### POWER SOCKET



Electronic devices can be connected to the vehicle electrical system via the 12V power socket. One example of this is the BMW USB charger, which can be used to charge and operate mobile phones and MP3 players with an appropriate interface while riding.

To be fitted and/or enabled in a specialist workshop, ideally at your authorised BMW Motorrad dealership.





# ACCESSORIES FOR BMW F 750 GS



## HP PARTS

### HP SPORT SILENCER

The high-end titanium-clad silencer delivers an impressively rich sound and is a clear avowal to racing, both visually and acoustically. The high-quality slip-on model offers a weight saving of approx. 2.3 kg compared to the standard model thanks to its lightweight design.

Note the differences in national-market versions.  
To be fitted and/or enabled in a specialist workshop, ideally at your authorised BMW Motorrad dealership.

#### 1 HP Sports silencer



#### 2 HP Sports silencer, black



### HP CLUTCH LEVER/HP HANDBRAKE LEVER

The HP clutch lever made of grey anodised aluminium emphasises the sportiness of the bike and can be ergonomically adjusted to the hand width in three steps.

The HP handbrake lever can be ergonomically adjusted to the hand width in five steps. Both are milled from a high-strength aluminium alloy that is completely resistant to corrosion and integrate perfectly into the bike's sporty design in terms of colour.

To be fitted and/or enabled in a specialist workshop, ideally at your authorised BMW Motorrad dealership.





# STORAGE

## VARIABLE TOPCASE

The variable topcase with its patented two-stage adjustment mechanism offers a variable volume from 25 to 35 litres. The black topcase made of robust plastic is waterproof, suitable for off-road use and has a large GS inscription.

Only available in conjunction with a topcase rack. For information on speed and load limitations, please refer to the instruction booklet.

### 1 Variable topcase



### 2 Backrest pad for variable topcase



## VARIABLE CASES

The variable cases are fitted with a patented adjustment system, allowing their capacity to be reduced from 68l (39l left, 29l right) to 50l (30l left, 20l right). This is particularly useful in city traffic, because the width is reduced by 120mm.

Not available in combination with case rack.  
For information on speed and load limitations, please refer to the instruction booklet.



## LINER FOR VARIABLE CASE AND VARIABLE TOPCASE

The liners for the variable case and variable topcase get the luggage organised and facilitates loading and unloading. The bag is quick to hand and easy to carry thanks to the carry handle and shoulder strap. Practical details include the mesh partition with a zippered compartment in the lid and the volume which can be varied by an all-round zipper.



## CASE AND TOPCASE RACKS FOR VARIABLE CASE AND VARIABLE TOPCASE

The variable cases can be easily and securely attached to the sturdy case racks on both sides of the motorcycle. The topcase holder is used to securely mount the variable topcase.

### 1 Case holder for variable case



### 2 Topcase carrier for variable topcase



## TANK BAG, 8-14 L

The tank bag with an expandable volume from 8 to 14 litres is the ideal companion for short trips. The water-repellent external pocket, the splash-proof cable duct, the integrated rain cover with a transparent window and the all-round function bar are practical features that leave nothing to be desired.

For information on speed and load restrictions, please refer to the instruction booklet.



## MAP POCKET FOR TANK BAG

Even today, many tour riders do not want to do without reliable road maps. The ideal solution is the removable map pocket in A4 format with waterproof roll closure. It can be fastened securely to the tank bag with hook and loop fasteners; the stiffened bottom prevents it from flapping in the oncoming wind.







**BAG FOR PASSENGER SEAT, 2.5-8 L**

With a volume of 2.5 to 8 litres, this durable bag for the passenger seat offers enough storage space for the daily ride to work or for day trips. The three-sided zip fastener allows quick access, while the functional carrying handle facilitates transport.

For information on speed and load restrictions, please refer to the instruction booklet.



**ADDITIONAL BAG UNDER LUGGAGE GRID**

The small and practical bag made of durable polyester fabric with a PVC coating creates additional stowage space under the luggage grid. This means that smaller items that the rider does not want to do without on the road are always on board.

Not available in conjunction with the aluminium luggage grid.



DESIGN

**DECORATIVE STICKER SETS**

Attracts everyone's attention: the decorative sticker sets are perfectly tailored to the motorcycle and create an attractive, unique look. The stickers are characterised by metallic colour effects and high colour brilliance. Moreover, the tapes are extremely weather-resistant and can be attached easily and bubble-free using the supplied mounting accessories.

**1 Decorative Free sticker set**



**2 Decorative Fresh sticker set**



**3 Decorative Lines sticker set**



**4 Decorative New Ways sticker set**



**LED INDICATORS**

A shining example: The beautifully designed LED indicators with white turn indicator glass convince with their slim design and modern lighting technology. They respond much faster than incandescent lamps and are virtually wear-free. This provides a clear safety advantage in road traffic.

Note the differences in national-market versions. To be fitted and/or enabled in a specialist workshop, ideally at your authorised BMW Motorrad dealership.





# ERGONOMICS & COMFORT

## WINDSCREENS

The small, tinted windscreen impresses with good wind and weather protection and emphasises the sporty look of the motorcycle.

The large, tinted windscreen offers superior wind and weather protection and emphasises the sporty look of the motorcycle.

With the windscreen adjustment, the rider can vary the position of the large windscreen and the touring windscreen in two stages.

Note the differences in national-market versions. To be fitted and/or enabled in a specialist workshop, and ideally at your authorised BMW Motorrad dealership.

1 Small windscreen, tinted



2 Large windscreen, tinted



3 Large windscreen, clear



4 Windscreen adjustment



## SEATS

The comfort seat with its additional upholstery and a wider seat area offers noticeable benefits in seating comfort and therefore even more carefree miles for both rider and passenger.

15 mm lower than the standard version, this low seat makes climbing on and off easier and keeps the ground within easy reach. Many riders feel safer thanks to the reduced seat height, because they can manoeuvre and control their bike more easily. The attractive two-colour design in black/red or black/grey contributes to the individualisation of the motorcycle.

The higher Rallye seat impresses thanks to its great ground accessibility, particularly hard padding for off-road use and striking Enduro appearance.

The standard seat with its two-colour design in black/red or black/grey contributes to the customisation of the motorcycle.

1 Comfort seat



2 Low seat, black/grey



3 Low seat, black/red



4 Rallye seat



5 Seat, black/grey



6 Seat, black/red



## ENDURO FOOTREST & FOOT LEVER

The wider and longer stainless steel Enduro footrest offers more grip and allows better off-road vehicle control. The gear lever with adjustable kick lever can be operated even better, especially when riding off-road in a standing position. The height-adjustable footbrake lever has a wider step and a patented folding mechanism.

To be fitted and/or enabled in a specialist workshop, ideally at your authorised BMW Motorrad dealership.



## RIDER FOOTRESTS, ADJUSTABLE

The spring-loaded rider footrest with plastic footplate is adjustable in three positions and offers maximum comfort and surefootedness on and off-road. This means additional stability and even better control of the motorcycle when riding in a standing position, especially off-road.

To be fitted and/or enabled in a specialist workshop, ideally at your authorised BMW Motorrad dealership.

1 Adjustable rider footrest



2 Adjustable rider footrest, black





**AUTOMATIC CHAIN LUBRICATION SYSTEM**

The chain lubricating system automatically supplies the drive chain with lubricant while riding. However, the system only works while the engine is running. The continuous lubrication minimises friction and wear of the chain drive, reduces maintenance and care efforts and thus increases the service life of the chain.

To be fitted and/or enabled in a specialist workshop, ideally at your authorised BMW Motorrad Retailer.



**CENTRE STAND (NOT SHOWN)**

The stable centre stand ensures a safe standing position for the motorcycle even on slopes and offers advantages, for example, when mounting cases and topcases or for minor maintenance work such as tyre pressure control or chain maintenance. The motorcycle also takes up less space when parked upright.

Not available in conjunction with OE No. 499 lowered suspension option.  
To be fitted and/or enabled in a specialist workshop, ideally at your authorised BMW Motorrad Retailer.

**HANDLEBAR RISER (NOT SHOWN)**

The handlebar extension of 15 mm allows a comfortable sitting and standing position and makes handling the bike off-road noticeably easier.

Not available in conjunction with OE navigation preparation and OA smartphone cradle bracket.  
To be fitted and/or enabled in a specialist workshop, ideally at your authorised BMW Motorrad Retailer.

**HEATED GRIPS AND SWITCHES (NOT SHOWN)**

Comfort meets safety. The practical heated grips keep hands pleasantly warm even on cold days and also more responsive. The grip heating controlled by the on-board computer continuously detects the outside temperature via sensors and adjusts the heat output.

To be fitted and/or enabled in a specialist workshop, ideally at your authorised BMW Motorrad Retailer.

**PRO GEAR-SHIFT ASSIST (NOT SHOWN)**

The shift assistant Pro allows shifting up and down in almost all load ranges and engine speed ranges without actuating the clutch or throttle. The assistant thus ensures noticeably reduced shifting times, a relief of the clutch hand and thus greater comfort and dynamics.

To be fitted and/or enabled in a specialist workshop, ideally at your authorised BMW Motorrad Retailer.

**PRO RIDING MODES RETROFIT SET (NOT SHOWN)**

The Pro riding modes can be retroactively retrofitted using an activation code. Riders of older motorcycles therefore do not have to do without modern safety features. Depending on the year of manufacture, retrofitting is possible with the Pro, Pro with DTC or Pro with ABS Pro, DTC and HSC modes.

To be fitted and/or enabled in a specialist workshop, ideally at your authorised BMW Motorrad Retailer.





# NAVIGATION & COMMUNICATION

## BMW MOTORRAD NAVIGATOR VI

With the multifunctional Navigator VI, route planning becomes child's play. The system with 16 GB flash memory and a five-inch touch screen always shows the right way. Thanks to the circular polarisation filter (CPOL), the waterproof display is easy to read even in direct sunlight. The high-resolution screen in a casing similar to a smartphone provides all the essential information and ensures that you can see the big picture required in every situation. Numerous additional functions make planning and touring an exciting experience. Plan your routes can be created according to your personal preferences and enjoy driving on winding and quiet side roads. In unknown terrain, the "round trip" option is a good choice as it reliably guides the rider at the end of the tour back to the starting point. The Bluetooth connection to the BMW Motorrad communication system and the optional Smartphone Link app enable multimedia on the go: navigation announcements, telephone calls and music streaming as well as the retrieval of weather forecasts or traffic jam information are no problem. Navigation preparation adds further functions such as "My Motorcycle", and the multi-controller on the handlebars offers an alternative control option. Choose the pre-installed map data, and you will always be up to date thanks to lifelong, free map updates.



Note the differences in national-market versions.  
 Only available in conjunction with OE navigation preparation.

## BMW MOTORRAD SMARTPHONE CRADLE

BMW Motorrad's robust smartphone cradle provides a safe and protected place for your smartphone. This means that useful functions such as navigation information and online information can also be used while you are on the move. Thanks to the handy charging function, your smartphone is also always ready for action on extended bike tours.

Only in combination with bracket for BMW Motorrad navigation devices.



## NAVIGATION PREPARATION RETROFIT SET (NOT SHOWN)

The navigation preparation retrofit set with a holder and Mount Cradle for the instrument cluster integrates the BMW Navigator neatly into the cockpit and thus into the rider's direct field of vision. The navigation system is secured against theft and can be conveniently operated via the Multi-Controller on the handlebars.

Not available in conjunction with the Smartphone Cradle or handlebar extension.  
 To be fitted and/or enabled in a specialist workshop, ideally at your authorised BMW Motorrad Retailer.

# SAFETY

## HAND PROTECTORS



The hand protector, made of impact-resistant and UV-resistant plastic, also protects the operating elements against branches and stone chips while riding off-road, and is aerodynamically tailored to the vehicle. On the road, the wind and weather protection offered by the protectors is also impressive: hands and fingers stay longer dry and warm even at low temperatures.

To be fitted and/or enabled in a specialist workshop, ideally at your authorised BMW Motorrad Retailer.

## ENDURO ALUMINIUM ENGINE GUARD (NOT SHOWN)

This sturdy Enduro aluminium engine guard was specially constructed for off-road use and provides optimal protection for the lower section of the engine.

To be fitted and/or enabled in a specialist workshop, ideally at your authorised BMW Motorrad Retailer.

## PLASTIC ENGINE GUARD



The robust plastic engine guard protects the engine against flying stones. The necessary attachments are included.

To be fitted and/or enabled in a specialist workshop, ideally at your authorised BMW Motorrad Retailer.

## ENGINE PROTECTION BAR



The stainless steel engine protection bar provides effective protection for the motor housing without compromising the lean angle.

To be fitted and/or enabled in a specialist workshop, ideally at your authorised BMW Motorrad Retailer.



**HEADLIGHT GUARD  
(FOR OFF-ROAD USE ONLY)**



The stable headlight guard effectively protects the bike in demanding Enduro use against damage to the LED headlight. The polycarbonate headlight guard does not have vehicle type approval, but can be attached to and detached from the headlight in a matter of seconds once the supplied adapter has been installed.

To be fitted and/or enabled in a specialist workshop, ideally at your authorised BMW Motorrad Retailer.

**PROTECTIVE GLASS FOR  
6.5-INCH TFT DISPLAY**



The protective glass reliably protects the 6.5-inch TFT display from dirt, flying stones and damage. The hardened glass has an anti-glare and anti-reflective surface, so that the TFT display can be read easily. With BMW Motorrad inscription.

To be fitted and/or enabled in a specialist workshop, ideally at your authorised BMW Motorrad Retailer.

**LED ADDITIONAL HEADLIGHTS**



The powerful LED additional headlights in a compact aluminium housing ensure better vision and visibility even in fog, rain or snowfall. At the same time, with their white, daylight-like light colour, they ensure differentiated illumination of the road, thus perfectly complementing the main headlight. LED technology ensures virtually wear-free operation.

To be fitted and/or enabled in a specialist workshop, ideally at your authorised BMW Motorrad Retailer.

**ANTI-THEFT ALARM  
RETROFIT SET  
(NOT SHOWN)** NEW

Strong protection from theft: If the motorcycle is moved or struck violently, the anti-theft alarm system responds with a clearly audible signal and a flashing warning light. The acoustic and optical warning will draw the attention of passers-by quickly. The alarm system is activated automatically when the ignition is switched off.

Note the differences in national-market versions. To be fitted and/or enabled in a specialist workshop, ideally at your authorised BMW Motorrad Retailer.

**TYRE PRESSURE CONTROL  
RETROFIT SET  
(NOT SHOWN)**

Tyre Pressure Control (TPC) with all functions can be retrofitted by installing the control unit. TPC provides reliable information about the current tyre pressure and warns the rider about pressure loss at an early stage. The corresponding notifications and instructions are provided by the on-board computer in the cockpit.

To be fitted and/or enabled in a specialist workshop, ideally at your authorised BMW Motorrad Retailer.

**OUTPUT REDUCTION  
RETROFIT SET  
(NOT SHOWN)**

The power reduction retrofit to 35 kW (48 hp) is an attractive option for beginners and returning riders. This leaves nothing to be desired when it comes to riding pleasure and feeling. The engine can be brought back to its full power later on, if desired. The power reduction is carried out by means of an enabling code.

To be fitted and/or enabled in a specialist workshop, ideally at your authorised BMW Motorrad Retailer.

**ABS PRO RETROFIT SET  
(NOT SHOWN)**

To be fitted and/or enabled in a specialist workshop, ideally at your authorised BMW Motorrad Retailer.

**ACTIVATION CODE FOR DTC  
(NOT SHOWN)**

Dynamic Traction Control (DTC) ensures greater riding stability and controls wheel slip even when leaning into corners to prevent the rear wheel from spinning. Depending on the riding mode, DTC allows more or less slip and thus guarantees the maximum safety and riding dynamics on different routes.

To be fitted and/or enabled in a specialist workshop, ideally at your authorised BMW Motorrad Retailer.





# ACCESSORIES FOR BMW F 850 GS



## HP PARTS

### HP SPORT SILENCER

The high-end titanium-clad silencer delivers an impressively rich sound and is a clear avowal to racing, both visually and acoustically. The high-quality slip-on model offers a weight saving of approx. 2.3 kg compared to the standard model thanks to its lightweight design.

Note the differences in national-market versions.  
To be fitted and/or enabled in a specialist workshop, ideally at your authorised BMW Motorrad Retailer.

1 HP sports silencer



2 HP sports silencer, black



### HP CLUTCH LEVER/HP HANDBRAKE LEVER

The HP clutch lever made of grey anodised aluminium emphasises the sportiness of the bike and can be ergonomically adjusted to the hand width in three steps.

The HP handbrake lever can be ergonomically adjusted to the hand width in five steps. Both are milled from a high-strength aluminium alloy that is completely resistant to corrosion and integrates perfectly into the bike's sporty design in terms of colour.

To be fitted and/or enabled in a specialist workshop, ideally at your authorised BMW Motorrad Retailer.





# STORAGE

## ALUMINIUM CASES

The perfect solution for touring fans who place the highest demands on themselves and their equipment: the aluminium case for mounting on the left-hand side offers 44 litres of storage space. This robust piece of transport equipment is dust- and waterproof. Many functional details impress even under extreme conditions. The perfect solution for touring fans who place the highest demands on themselves and their equipment: The aluminium case for mounting on the right-hand side offers 36 litres of storage space. This robust piece of transport equipment is dust- and waterproof. Many practical details impress even under extreme conditions.

Not available in conjunction with LED indicators at the rear with short base TNR 8 522 499; install LED indicators with long base TNR 8 522 500 if necessary. For information on speed and load restrictions, please refer to the instruction booklet.

1 Aluminium case



2 Aluminium case, black



## ALUMINIUM TOPCASE

The waterproof topcase has a capacity of 32 litres and lashing eyes for securing additional luggage. And with the optional backrest pad added, it provides increased comfort for the passenger.

For information on speed and load limitations, please refer to the instruction booklet.

1 Aluminium topcase, black, 32l



2 Aluminium topcase, 32l



3 Backrest pad for aluminium topcase



## CASE HOLDER AND TOPCASE CARRIER FOR ALUMINIUM CASE AND ALUMINIUM TOPCASE

The aluminium case can be easily and securely attached to the sturdy case rack made of polished stainless steel. The stainless steel crossbar connects the right and left case rack and ensures a high level of stability even when the bike has a full load. The aluminium topcase can be easily and securely attached to the sturdy topcase carrier made of polished stainless steel.

1 Case holder for aluminium case, left and right

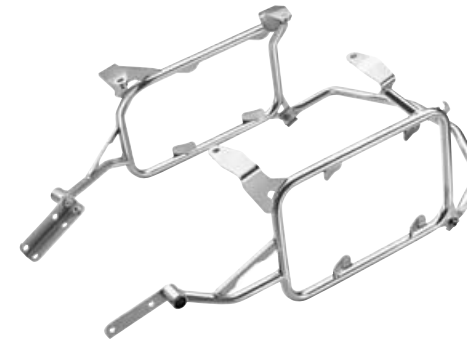

2 Topcase carrier for aluminium topcase



## LINER FOR ALUMINIUM CASES AND TOPCASE

The waterproof liner gets the luggage organised and facilitates loading and unloading. The carry handle and shoulder strap make the bag easy to access and transport. Alternatively, the sturdy bag can also be attached to the outside of the case, creating additional storage space.

## CARRY HANDLE FOR ALUMINIUM CASE/TOPCASE

Convenient and functional: The practical carry handles for aluminium cases and topcases make it easy to transport the luggage to and from the bike. If the cases are mounted, additional luggage can also be attached to the handles.





**LUGGAGE COMPARTMENT SEPARATING NET FOR ALUMINIUM CASES**

The luggage net for aluminium cases and topcases creates more order and makes it easier to access frequently used items. The highly flexible net is attached to the inside of the lid and ensures that luggage such as raincoats, folding backpacks, toiletry bags and sneakers are always at hand when the case is opened.



**ATACAMA LUGGAGE SYSTEM**

The Atacama side bags convince with clever details and a combined storage volume of 60 litres. In addition to the waterproof liners, various storage compartments provide additional space. Quick-release fasteners for easy mounting on the motorcycle and sturdy carry handles ensure a secure hold and extremely practical handling.

The extremely durable Atacama roll bag sports many clever details and an enormous storage volume of 40 litres.

The Atacama side bags and roll bag and other pieces of luggage or helmets can be secured to the motorcycle using the lockable tension straps with steel core.

**1**  
Only available in conjunction with case holder for aluminium cases. For information on speed and load restrictions, please refer to the instruction booklet.

**3**  
For information on speed and load limitations, please refer to the instruction booklet. Worn off at points of contact.

**1 Atacama side bags**



**2 Tensioning straps for Atacama side bags, lockable**



**3 Atacama roll bag, 40l**



**4 Tensioning strap for Atacama roll bag, lockable**



**VARIABLE CASES**

With its patented adjustment mechanism, the variable cases offer stowage space of 30 to 39 litres (left) and 20 to 29 litres (right). The adjustable volume offers benefits, especially in city traffic, as the width of the cases can be reduced at the same time. Naturally the variable cases are waterproof and also suitable for off-road use.

Only available in combination with case holder. For information on speed and load limitations, please refer to the instruction booklet.



**VARIABLE TOPCASE**

The variable topcase with its patented two-stage adjustment mechanism offers a variable volume from 25 to 35 litres. The black topcase made of robust plastic is waterproof, suitable for off-road use and has a large GS inscription.

Only available in conjunction with a topcase holder. For information on speed and load limitations, please refer to the instruction booklet.

**1 Variable topcase**



**2 Backrest pad for variable topcase**



**CASE HOLDER AND TOPCASE CARRIER FOR VARIABLE CASE AND VARIABLE TOPCASE**

The variable cases can be easily and securely attached to the sturdy case holders on both sides of the motorcycle.

The topcase carrier is used to securely mount the variable topcase.

Only available in conjunction with a topcase rack. For information on speed and load limitations, please refer to the instruction booklet.

**1 Case holders for variable cases**



**2 Topcase carrier for variable topcase**





**LINER FOR VARIABLE CASE AND TOPCASE**

The liners for the variable case and the variable topcase gets the luggage organised and facilitates loading and unloading. The bag is quick to hand and easy to carry thanks to the carry handle and shoulder strap. Practical details include the mesh partition with a zipped compartment in the lid and the volume which can be varied by an all-round zip.



**TANK BAG, 8-14 L**

The tank bag with an expandable volume from 8 to 14 litres is the ideal companion for short trips. The water-repellent external pocket, the splash-proof cable duct, the integrated rain cover with a transparent window and the all-round function bar are practical features that leave nothing to be desired.

For information on speed and load limitations, please refer to the instruction booklet.



**MAP POCKET FOR TANK BAG**

Even today, many tour riders do not want to do without reliable road maps. The ideal solution is the removable map pocket in A4 format with waterproof roll closure. It can be fastened securely to the tank bag with hook and loop fasteners; the stiffened bottom prevents it from flapping in the oncoming wind.



**BAG FOR PASSENGER SEAT, 2.5-8 L**

With a volume of 2.5 to 8 litres, this durable bag for the passenger seat offers enough storage space for the daily ride to work or for day trips. The three-sided zip fastener allows quick access, while the functional carrying handle facilitates transport.

For information on speed and load restrictions, please refer to the instruction booklet.



**ADDITIONAL BAG UNDER LUGGAGE GRID**

The small and practical bag made of durable polyester fabric with a PVC coating creates additional stowage space under the standard luggage grid. This means that smaller items that the rider does not want to do without on the road are always on board.

Not available in conjunction with the aluminium luggage grid.



**DESIGN**

**LED INDICATORS**

A shining example: The beautifully designed LED indicators with white turn indicator glass convince with their slim design and modern lighting technology. They respond much faster than incandescent lamps and are virtually wear-free. This provides a clear safety advantage in road traffic.

Note the differences in national-market versions. To be fitted and/or enabled in a specialist workshop, ideally at your authorised BMW Motorrad Retailer.



**DECORATIVE STICKER SETS**

Attracts everyone's attention: the decorative sticker sets are perfectly tailored to the motorcycle and create an attractive, unique look. The stickers are characterised by metallic colour effects and high colour brilliance. Moreover, the tapes are extremely weather-resistant and can be attached easily and bubble-free using the supplied mounting accessories.

**1 Decorative Free sticker set**



**2 Decorative Fresh sticker set**



**3 Decorative Lines sticker set**



**4 Decorative New Ways sticker set**





# ERGONOMICS & COMFORT

## ENDURO FOOTREST/FOOT LEVER

The wider and longer stainless steel Enduro footrest offers more grip and allows better off-road vehicle control. The gear lever with adjustable kick lever can be operated even better, especially when riding off-road in a standing position. The height-adjustable footbrake lever has a wider step and a patented folding mechanism.

To be fitted and/or enabled in a specialist workshop, ideally at your authorised BMW Motorrad Retailer.



## RIDER FOOTRESTS, ADJUSTABLE

The spring-loaded rider footrest with plastic footplate is adjustable in three positions and offers maximum comfort and surefootedness on and off-road. This means additional stability and even better control of the motorcycle when riding in a standing position, especially off-road.

To be fitted and/or enabled in a specialist workshop, ideally at your authorised BMW Motorrad Retailer.

### 1 Rider footrests, adjustable



### 2 Black rider footrest, adjustable



## WINDSCREENS

The touring windscreen is approx. 80mm higher and 30mm wider than the standard windscreen and therefore offers noticeably improved wind and weather protection as well as greater overall touring comfort. The scratch-resistant coating guarantees lasting transparency, while the clear look emphasises the high-quality appearance.

The small windscreen impresses with good wind and weather protection and underlines the sporty look of the motorcycle. The scratch-resistant coating ensures long-term unimpeded visibility. The small version is slightly lower than the standard windscreen but just as wide.

The large windscreen offers superior wind and weather protection for the rider and impresses with improved touring comfort.

With the windscreen adjustment, the rider can vary the position of the large windscreen and the touring windscreen in two stages.

To be fitted and/or enabled in a specialist workshop, ideally at your authorised BMW Motorrad Retailer. Please note the specifications for different countries.

### 1 Touring windscreen, clear



### 2 Touring windscreen, tinted



### 3 Small windscreen, clear



### 4 Small windscreen, tinted



### 5 Large windscreen, tinted



### 6 Windscreen adjustment



## HIGH HANDLEBARS (NOT SHOWN)

The high handlebars are 14mm higher than the standard handlebars. This not only enables an upright and comfortable sitting position, but also makes riding while standing particularly comfortable. Secure handling of the motorcycle is noticeably easier (particularly in the standing position) – an indispensable advantage for Enduro riders.

To be fitted and/or enabled in a specialist workshop, ideally at your authorised BMW Motorrad Retailer.

## RALLYE SEAT

Increased seat height, narrow shape for great ground accessibility, particularly hard padding for off-road use – the Rallye seat has everything to be desired for tough Enduro use. Moreover, its slim silhouette impressively emphasises the motorcycle's striking off-road look.



## COMFORT SEAT

The comfort seat with its additional upholstery and a wider seat area offers noticeable benefits in seating comfort and therefore even more carefree miles for both rider and passenger.





**TWO-COLOURED SEAT**

15 mm lower than the standard version, this low seat makes climbing on and off easier and keeps the ground within easy reach. Many riders feel safer thanks to the reduced seat height, because they can manoeuvre and control their bike more easily. The attractive two-colour design in black/red or black/grey contributes to the individualisation of the motorcycle.

The standard seat with its two-colour design in Black/Red or Black/Grey contributes to the customisation of the motorcycle.

- 1 Seat height: 790 mm; step length: 1,790 mm
- 2 Seat height: 790 mm; step length: 1,790 mm

- 3 Seat height: 815 mm; step length: 1,830 mm
- 4 Seat height: 815 mm; step length: 1,830 mm

1 Low seat, black/grey



2 Low seat, black/red



3 Seat, black/grey



4 Seat, black/red



**CENTRE STAND (NOT SHOWN)**

The stable main stand ensures a safe standing position for the motorcycle even on slopes and offers advantages, for example, when mounting cases and topcases or for minor maintenance work such as tyre pressure control or chain maintenance. The motorcycle also takes up less space when parked upright.

Not available in conjunction with OE No. 499 lowered suspension option.  
 To be fitted and/or enabled in a specialist workshop, ideally at your authorised BMW Motorrad Retailer.

**PRO GEAR-SHIFT ASSIST (NOT SHOWN)**

The shift assistant Pro allows shifting up and down in almost all load ranges and engine speed ranges without actuating the clutch or throttle. The assistant thus ensures noticeably reduced shifting times, a relief of the clutch hand and thus greater comfort and dynamics.

To be fitted and/or enabled in a specialist workshop, ideally at your authorised BMW Motorrad Retailer.

**HEATED GRIPS AND SWITCHES (NOT SHOWN)**

Comfort meets safety. The practical heated grips keep hands pleasantly warm even on cold days and also more responsive. The grip heating controlled by the on-board computer continuously detects the outside temperature via sensors and adjusts the heat output.

To be fitted and/or enabled in a specialist workshop, ideally at your authorised BMW Motorrad Retailer.

**PRO RIDING MODES RETROFIT SET (NOT SHOWN)**

The Pro riding modes can be retrofitted using an enabling code. Riders of older motorcycles therefore do not have to do without modern safety features. Depending on the year of manufacture, retrofitting is possible with the Pro, Pro with DTC or Pro with ABS Pro, DTC and HSC modes.

To be fitted and/or enabled in a specialist workshop, ideally at your authorised BMW Motorrad Retailer.

**NAVIGATION & COMMUNICATION**

**BMW MOTORRAD NAVIGATOR VI**

With the multifunctional Navigator VI, route planning becomes child's play. The system with 16 GB flash memory and a five-inch touch screen always shows the right way. Thanks to the circular polarisation filter (CPOL), the waterproof display is easy to read even in direct sunlight. The high-resolution screen in a casing similar to a smartphone provides all the essential information and ensures that you can see the big picture required in every situation. Numerous additional functions make planning and touring an exciting experience. Plan your routes can be created according to your personal preferences and enjoy driving on winding and quiet side roads. In unknown terrain, the "round trip" option is a good choice as it reliably guides the rider at the end of the tour back to the starting point. The Bluetooth connection to the BMW Motorrad communication system and the optional Smartphone Link app enable multimedia on the go: navigation announcements, telephone calls and music streaming as well as the retrieval of weather forecasts or traffic jam information are no problem. Navigation preparation adds further functions such as "My Motorcycle", and the multi-controller on the handlebars offers an alternative control option. Choose the pre-installed map data, and you will always be up to date thanks to lifelong, free map updates.



Note the differences in national-market versions.  
 Only available in conjunction with OE navigation preparation.

**BMW MOTORRAD SMARTPHONE CRADLE**

BMW Motorrad's robust smartphone cradle provides a safe and protected place for your smartphone. This means that useful functions such as navigation information and online information can also be used while you are on the move. Thanks to the handy charging function, your smartphone is also always ready for action on extended bike tours.

Only in combination with bracket for BMW Motorrad navigation devices.



Original BMW Motorrad equipment is available from your authorised BMW Motorrad Retailer.



# SAFETY

## HAND PROTECTORS

The hand protector, made of impact-resistant and UV-resistant plastic, also protects the operating elements against branches and stone chips while riding off-road, and is aerodynamically tailored to the vehicle. On the road, the wind and weather protection offered by the protectors is also impressive: hands and fingers stay longer dry and warm even at low temperatures.

To be fitted and/or enabled in a specialist workshop, ideally at your authorised BMW Motorrad Retailer.



## ENDURO ALUMINIUM ENGINE GUARD (NOT SHOWN)

This sturdy Enduro aluminium engine guard was specially constructed for off-road use and provides optimal protection for the lower section of the engine.

To be fitted and/or enabled in a specialist workshop, ideally at your authorised BMW Motorrad Retailer.

## ENGINE PROTECTION BAR



The stainless steel engine protection bar provides effective protection for the motor housing without compromising the lean angle.

To be fitted and/or enabled in a specialist workshop, ideally at your authorised BMW Motorrad Retailer.

## LED ADDITIONAL HEADLIGHTS



The powerful LED additional headlights in a compact aluminium housing ensure better vision and visibility even in fog, rain or snowfall. At the same time, with their white, daylight-like light colour, they ensure differentiated illumination of the road, thus perfectly complementing the main headlight. LED technology ensures virtually wear-free operation.

## HEADLIGHT GUARD (FOR OFF-ROAD USE ONLY)

The stable headlight guard effectively protects the bike in demanding Enduro use against damage to the LED headlight. The polycarbonate headlight guard does not have vehicle type approval, but can be attached to and detached from the headlight in a matter of seconds once the supplied adapter has been installed.

To be fitted and/or enabled in a specialist workshop, ideally at your authorised BMW Motorrad Retailer.



## PROTECTIVE GLASS FOR 6.5-INCH TFT DISPLAY

The protective glass reliably protects the 6.5-inch TFT display from dirt, flying stones and damage. The hardened glass has an anti-glare and anti-reflective surface, so that the TFT display can be read easily. With BMW Motorrad inscription.



## ANTI-THEFT ALARM RETROFIT SET (NOT SHOWN) NEW

Strong protection from theft: If the motorcycle is moved or struck violently, the anti-theft alarm system responds with a clearly audible signal and a flashing warning light. The acoustic and optical warning will draw the attention of passers-by quickly. The alarm system is activated automatically when the ignition is switched off.

Note the differences in national-market versions. To be fitted and/or enabled in a specialist workshop, ideally at your authorised BMW Motorrad Retailer.

## TYRE PRESSURE CONTROL RETROFIT SET (NOT SHOWN)

Tyre Pressure Control (TPC) with all functions can be retrofitted by installing the control unit. TPC provides reliable information about the current tyre pressure and warns the rider about pressure loss at an early stage. The corresponding notifications and instructions are provided by the on-board computer in the cockpit.

To be fitted and/or enabled in a specialist workshop, ideally at your authorised BMW Motorrad Retailer.

## ABS PRO RETROFIT SET (NOT SHOWN)

To be fitted and/or enabled in a specialist workshop, ideally at your authorised BMW Motorrad Retailer.





## MAINTENANCE & TECHNOLOGY

### AUTOMATIC CHAIN LUBRICATION SYSTEM

The chain lubricating system automatically supplies the drive chain with lubricant while riding. However, the system only works while the engine is running. The continuous lubrication minimises friction and wear of the chain drive, reduces the amount of maintenance and care needed and thus increases the service life of the chain.

To be fitted and/or enabled in a specialist workshop, ideally at your authorised BMW Motorrad Retailer.



### OUTPUT REDUCTION RETROFIT SET (NOT SHOWN)

The power reduction retrofit to 35 kW (48 hp) is an attractive option for beginners and returning riders. This leaves nothing to be desired when it comes to riding pleasure and feeling. The engine can be brought back to its full power later on, if desired. The power reduction is carried out by means of an enabling code.

To be fitted and/or enabled in a specialist workshop, ideally at your authorised BMW Motorrad Retailer.





# ACCESSORIES FOR BMW F 850 GS ADVENTURE



## HP PARTS

### HP SPORT SILENCER

The high-end titanium-clad silencer delivers an impressively rich sound and is a clear avowal to racing, both visually and acoustically. The high-quality slip-on model offers a weight saving of approx. 2.3 kg compared to the standard model thanks to its lightweight design.

Note the differences in national-market versions.  
To be fitted and/or enabled in a specialist workshop, ideally at your authorised BMW Motorrad Retailer.

#### 1 HP sports silencer



#### 2 HP sports silencer, black



### HP CLUTCH LEVER / HP HANDBRAKE LEVER

The HP clutch lever made of grey anodised aluminium emphasises the sportiness of the bike and can be ergonomically adjusted to the hand width in three steps.

The HP handbrake lever can be ergonomically adjusted to the hand width in five steps. Both are milled from a high-strength aluminium alloy that is completely resistant to corrosion and integrate perfectly into the bike's sporty design in terms of colour.

To be fitted and/or enabled in a specialist workshop, ideally at your authorised BMW Motorrad Retailer.



Original BMW Motorrad equipment is available from your authorised BMW Motorrad Retailer.



# STORAGE

## ALUMINIUM CASES

The perfect solution for touring fans who place the highest demands on themselves and their equipment: the aluminium case for mounting on the left-hand side offers 44 litres of storage space. This robust piece of transport equipment is dust- and waterproof. Many functional details impress even under extreme conditions. The perfect solution for touring fans who place the highest demands on themselves and their equipment: The aluminium case for mounting on the right-hand side offers 36 litres of storage space. This robust piece of transport equipment is dust- and waterproof. Many practical details impress even under extreme conditions.

Not available in conjunction with LED indicators at the rear with short base TNR 8 522 499; install LED indicators with long base TNR 8 522 500 if necessary. For information on speed and load restrictions, please refer to the instruction booklet.

1 Aluminium case



2 Aluminium case, black



## ALUMINIUM TOPCASE

The waterproof topcase has a capacity of 32 litres and lashing eyes for securing additional luggage. And with the optional backrest pad added, it provides increased comfort for the passenger.

For information on speed and load limitations, please refer to the instruction booklet.

1 Aluminium topcase, black, 32l



2 Aluminium topcase, 32l



3 Backrest pad for aluminium topcase



## CASE HOLDERS FOR ALUMINIUM CASES

The aluminium case can be easily and securely attached to the sturdy case rack made of polished stainless steel. The stainless steel crossbar connects the right and left case rack and ensures a high level of stability even when the bike has a full load. The aluminium topcase can be easily and securely attached to the sturdy topcase carrier made of polished stainless steel.

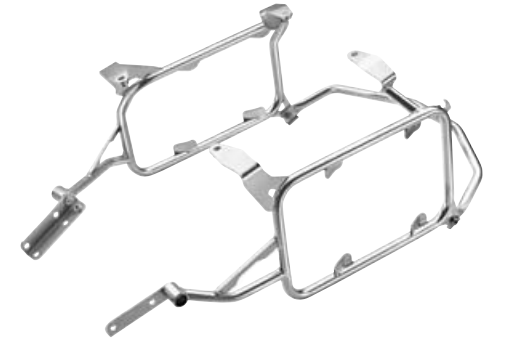

## CARRY HANDLE FOR ALUMINIUM CASE/TOPCASE



Convenient and functional: The practical carry handles for aluminium cases and topcases make it easy to transport the luggage to and from the bike. If the cases are mounted, additional luggage can also be attached to the handles.

## LINER FOR ALUMINIUM CASES AND TOPCASE



The waterproof liner gets the luggage organised and facilitates loading and unloading. The carry handle and shoulder strap make the bag easy to access and transport. Alternatively, the sturdy bag can also be attached to the outside of the case, creating additional storage space.

## LUGGAGE COMPARTMENT SEPARATING NET FOR ALUMINIUM CASES

The luggage net for aluminium cases and topcases creates more order and makes it easier to access frequently used items. The highly flexible net is attached to the inside of the lid and ensures that luggage such as raincoats, folding backpacks, toiletry bags and sneakers are always at hand when the case is opened.





**ATACAMA LUGGAGE SYSTEM**

The extremely durable Atacama luggage roll sports many clever details and an enormous storage volume of 40 litres. The Atacama side bags and roll bag and other pieces of luggage or helmets can be secured to the motorcycle using the lockable tension straps with steel core.

The Atacama side bags convince with clever details and a combined storage volume of 60 litres. In addition to the waterproof liners, various storage compartments provide additional space. Quick-release fasteners for easy mounting on the motorcycle and sturdy carry handles ensure a secure hold and extremely practical handling.

For information on speed and load restrictions, please refer to the instruction booklet. Only available in conjunction with case rack for aluminium cases. For information on individual speed and load restrictions, please refer to the instruction booklet.

**1 Atacama roll bag, 40 l**



**2 Tensioning strap for Atacama roll bag, lockable**



**3 Atacama side bags**



**4 Tensioning straps for Atacama side bags, lockable**

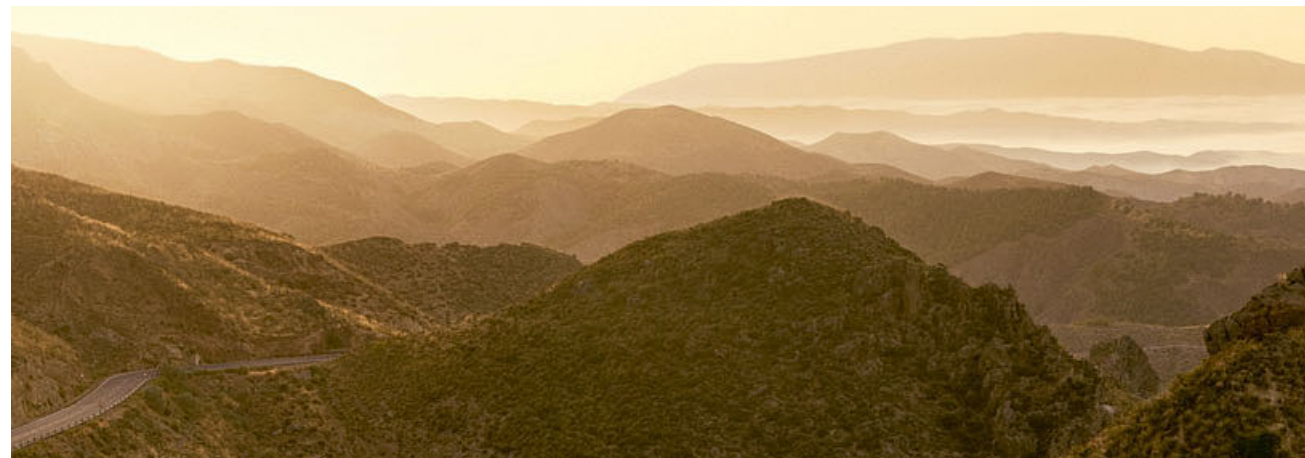

**TANK BAG, 8-14 L**

The tank bag with an expandable volume from 8 to 14 litres is the ideal companion for short trips. The water-repellent external pocket, the splash-proof cable duct, the integrated rain cover with a transparent window and the all-round function bar are practical features that leave nothing to be desired.

For information on speed and load limitations, please refer to the instruction booklet.

**MAP POCKET FOR TANK BAG**

Even today, many tour riders do not want to do without reliable road maps. The ideal solution is the removable map pocket in A4 format with waterproof roll closure. It can be fastened securely to the tank bag with hook and loop fasteners; the stiffened bottom prevents it from flapping in the oncoming wind.

**BAG FOR PASSENGER SEAT, 2.5-8 L**

With a volume of 2.5 to 8 litres, this durable bag for the passenger seat offers enough storage space for the daily ride to work or for day trips. The three-sided zip fastener allows quick access, while the functional carrying handle facilitates transport.

For information on speed and load restrictions, please refer to the instruction booklet.





# DESIGN

## LED INDICATORS

A shining example: The beautifully designed LED indicators with white turn indicator glass convince with their slim design and modern lighting technology. They respond much faster than incandescent lamps and are virtually wear-free. This provides a clear safety advantage in road traffic.



Note the differences in national-market versions. To be fitted and/or enabled in a specialist workshop, ideally at your authorised BMW Motorrad Retailer.

# ERGONOMICS & COMFORT

## RIDER FOOTRESTS, ADJUSTABLE

The spring-loaded rider footrest with plastic footplate is adjustable in three positions and offers maximum comfort and surefootedness on and off-road. This means additional stability and even better control of the motorcycle when riding in a standing position, especially off-road.

To be fitted and/or enabled in a specialist workshop, ideally at your authorised BMW Motorrad Retailer.

### 1 Rider footrests, adjustable



### 2 Black rider footrest, adjustable



## SEATS

15 mm lower than the standard version, this low seat makes climbing on and off easier and keeps the ground within easy reach. Many riders feel safer thanks to the reduced seat height, because they can manoeuvre and control their bike more easily. The attractive two-colour design in Black/Red or Black/Grey contributes to the individualisation of the motorcycle.

The standard seat with its two-colour design in Black/Red or Black/Grey contributes to the customisation of the motorcycle.

Increased seat height, narrow shape for great ground accessibility, particularly hard padding for off-road use – the Rallye seat has everything to be desired for tough Enduro use. Moreover, its slim silhouette impressively emphasises the motorcycle's striking off-road look.

1 Seat height: 790 mm;  
step length: 1,790 mm

3 Seat height: 815 mm;  
step length: 1,830 mm

5 Seat height: 845 mm;  
step length: 1,900 mm

### 1 Low seat, black/grey



### 2 Low seat, black/red



### 3 Seat, black/grey



### 4 Seat, black/red



### 5 Rallye seat





**WINDSCREENS**

The tinted touring windscreen is approx. 80mm higher and 30mm wider than the standard windscreen and therefore offers noticeably improved wind and weather protection as well as greater overall touring comfort. The scratch-resistant coating guarantees lasting transparency, the tinting additionally enhances the motorcycle's appearance.

The large windscreen offers superior wind and weather protection for the rider and impresses with improved touring comfort even on longer motorway stretches. The scratch-resistant coating ensures long-term unimpeded visibility.

The large, tinted windscreen offers superior wind and weather protection for the rider and impresses with improved touring comfort even on longer motorway stretches. The tint emphasizes the sporty look of the motorcycle, while the scratch-resistant coating ensures long-term unimpeded visibility.

The tinted wind deflectors with their stylish look give the bike a particularly casual touch and provide greater riding comfort on every journey.

To be fitted and/or enabled in a specialist workshop, ideally at your authorised BMW Motorrad Retailer.  
 Note the differences in national-market versions. To be fitted and/or enabled in a specialist workshop, ideally at your authorised BMW Motorrad Retailer.

**1 Touring windscreen, tinted**



**2 Large windscreen, clear**



**3 Large windscreen, tinted**



**4 Wind deflector, tinted**



**CENTRE STAND (NOT SHOWN)**

The stable main stand ensures a safe standing position for the motorcycle even on slopes and offers advantages, for example, when mounting cases and topcases or for minor maintenance work such as tyre pressure control or chain maintenance. The motorcycle also takes up less space when parked upright.

Not available in conjunction with OE No. 499 lowered suspension option.  
 To be fitted and/or enabled in a specialist workshop, ideally at your authorised BMW Motorrad Retailer.

**HEATED GRIPS AND SWITCHES (NOT SHOWN)**

Comfort meets safety. The practical heated grips keep hands pleasantly warm even on cold days and also more responsive. The grip heating controlled by the on-board computer continuously detects the outside temperature via sensors and adjusts the heat output.

To be fitted and/or enabled in a specialist workshop, ideally at your authorised BMW Motorrad Retailer.

**PRO GEAR-SHIFT ASSIST (NOT SHOWN)**

The shift assistant Pro allows shifting up and down in almost all load ranges and engine speed ranges without actuating the clutch or throttle. The assistant thus ensures noticeably reduced shifting times, a relief of the clutch hand and thus greater comfort and dynamics.

To be fitted and/or enabled in a specialist workshop, ideally at your authorised BMW Motorrad Retailer.

# NAVIGATION & COMMUNICATION

**BMW MOTORRAD NAVIGATOR VI**

With the multifunctional Navigator VI, route planning becomes child's play. The system with 16 GB flash memory and a five-inch touch screen always shows the right way. Thanks to the circular polarisation filter (CPOL), the waterproof display is easy to read even in direct sunlight. The high-resolution screen in a casing similar to a smartphone provides all the essential information and ensures that you can see the big picture required in every situation. Numerous additional functions make planning and touring an exciting experience. Plan your routes can be created according to your personal preferences and enjoy driving on winding and quiet side roads. In unknown terrain, the "round trip" option is a good choice as it reliably guides the rider at the end of the tour back to the starting point. The Bluetooth connection to the BMW Motorrad communication system and the optional Smartphone Link app enable multimedia on the go: navigation announcements, telephone calls and music streaming as well as the retrieval of weather forecasts or traffic jam information are no problem. Navigation preparation adds further functions such as "My Motorcycle", and the multi-controller on the handlebars offers an alternative control option. Choose the pre-installed map data, and you will always be up to date thanks to lifelong, free map updates.

Note the differences in national-market versions.  
 Only available in conjunction with OE navigation preparation.



**BMW MOTORRAD SMARTPHONE CRADLE**

BMW Motorrad's robust smartphone cradle provides a safe and protected place for your smartphone. This means that useful functions such as navigation information and online information can also be used while you are on the move. Thanks to the handy charging function, your smartphone is also always ready for action on extended bike tours.

Only in combination with bracket for BMW Motorrad navigation devices.





## SAFETY

### ENDURO ALUMINIUM ENGINE GUARD (NOT SHOWN)

This sturdy Enduro aluminium engine guard was specially constructed for off-road use and provides optimal protection for the lower section of the engine.

To be fitted and/or enabled in a specialist workshop, ideally at your authorised BMW Motorrad Retailer.

### LED ADDITIONAL HEADLIGHTS

The powerful LED additional headlights in a compact aluminium housing ensure better vision and visibility even in fog, rain or snowfall. At the same time, with their white, daylight-like light colour, they ensure differentiated illumination of the road, thus perfectly complementing the main headlight. LED technology ensures virtually wear-free operation.



### HEADLIGHT GUARD (FOR OFF-ROAD USE ONLY)



The stable headlight guard effectively protects the bike in demanding Enduro use against damage to the LED headlight. The polycarbonate headlight guard does not have vehicle type approval, but can be attached to and detached from the headlight in a matter of seconds once the supplied adapter has been installed.

To be fitted and/or enabled in a specialist workshop, ideally at your authorised BMW Motorrad Retailer.

### PROTECTIVE GLASS FOR 6.5-INCH TFT DISPLAY



The protective glass reliably protects the 6.5-inch TFT display from dirt, flying stones and damage. The hardened glass has an anti-glare and anti-reflective surface, so that the TFT display can be read easily. With BMW Motorrad inscription.

## MAINTENANCE & TECHNOLOGY

### AUTOMATIC CHAIN LUBRICATION SYSTEM

The chain lubricating system automatically supplies the drive chain with lubricant while riding. However, the system only works while the engine is running. The continuous lubrication minimises friction and wear of the chain drive, reduces the amount of maintenance and care needed and thus increases the service life of the chain.

To be fitted and/or enabled in a specialist workshop, ideally at your authorised BMW Motorrad Retailer.





# ACCESSORIES FOR BMW F 900 XR



## STORAGE

### TOURING CASE

With a volume of approx. 31 litres on the left and 32 litres on the right, the high-quality hard shell touring case offers ample space for luggage. The splashproof case with painted lid can be locked and is the perfect travel companion for short or longer tours.

Available in Asphalt grey metallic matt, Granite grey metallic matt (not shown), Light white and Racing red.

For information on speed and load restrictions, please refer to the instruction booklet.

1 Touring case in Asphalt grey metallic matt



2 Touring case, Light white



3 Touring case, Racing red



### LINER FOR TOURING CASE

The matching liner for the touring case gets the luggage organised and facilitates loading and unloading. The carry handle and shoulder strap make the bag easy to access and transport. Functional details include the three-sided zip fastener and separate net compartment in the lid.



### CASE HOLDER

NEW

The sturdy case holder allows easy and secure installation of the touring case. Even if the case is not mounted, the discreet black holder is hardly noticeable on the bike.



### SOFT CASE

NEW

The high-quality soft case made of durable polyester convinces with practical details and a storage volume of 20 litres (total volume of left soft case and right soft case). Features such as the waterproof liner, the all-round zipper, the carrying handle and the quick-release fastener for easy mounting on the motorcycle ensure a secure hold and practical handling.



### SMALL TOPCASE, 30 L

The waterproof plastic topcase offers enough space for a helmet with a volume of 30 litres. The lid, which is available in Asphalt Grey metallic matt, Black Storm metallic or Light White, and the soft-close hinges, which allow the lid to be lowered gently, underline the high-quality appeal.

Only in conjunction with luggage carrier, topcase carrier and corresponding outer shell. For information on speed and load limitations, please refer to the instruction booklet. For more detailed information, contact your authorised BMW Motorrad Retailer or go online at [bmw-motorrad.com](http://bmw-motorrad.com).



### LINER FOR TOPCASE

The matching tailored liner for the topcase gets the luggage organised and facilitates loading and unloading. The carry handle and shoulder strap make the bag easy to access and transport. The practical details include the outside pocket and the three-sided zipper.



### LARGE TANK BAG

NEW

The tank bag, made of durable polyester fabric, offers many intelligent details. Its volume can be extended from 11 to 16 litres as required. Extra space is available in the map pocket and exterior pockets. The smart belt fastener design guarantees a secure hold and extremely functional handling.





**SMALL TANK BAG**

NEW

The small, durable tank bag with belt attachment is the ideal companion for short trips. The main compartment with removable waterproof liner, the cable duct, the storage space volume of 5.5. litres, the carry handle and the removable shoulder strap are handy qualities that leave almost nothing to be desired.



**LUGGAGE GRID**

NEW

A topcase or other pieces of luggage can be easily and securely attached to the sturdy luggage carrier made of powder-coated die-cast aluminium. Since the luggage carrier is attached to the motorcycle in a vibration-free manner, the riding characteristics improve noticeably with the topcase mounted, especially at higher speeds.



DESIGN

**OPTION 719 SILVER MIRRORS**



The Option 719 silver-coloured mirrors are made of milled aluminium and highlight the high-quality character of the bike.

The low-vibration construction and aerodynamic shape ensure excellent visibility. The attractive design also creates a strong individualisation effect.

**ADJUSTABLE RIDER FOOTRESTS**

NEW



The rider footrest made of black anodised aluminium combines a dynamic look with ergonomics and sportiness at the highest level. Thanks to the ribbed tread surface and three-step height adjustment, it provides additional support and optimum vehicle control.

Available from Q3/2020.

**FOLDABLE BRAKE LEVER AND CLUTCH LEVER**

NEW



The handbrake lever can be adjusted in five positions for the preferred grip range and, thanks to the folding mechanism, has a defined folding moment.

The clutch lever can be adjusted in three positions for the preferred grip range and, thanks to the folding mechanism, has a defined folding moment.

Available from Q3/2020.

To be fitted and/or enabled in a specialist workshop, ideally at your authorised BMW Motorrad Retailer.

**HANDBRAKE LEVER AND CLUTCH LEVER PROTECTORS**

NEW



The clutch lever protector also makes a clear statement of uncompromising sportiness on the road. The curved bow made of aluminium and plastic protects the clutch lever on the handlebars from being unintentionally actuated due to contact with another vehicle or damaging the bike if it falls over.

The handbrake lever protector protects the handbrake lever from accidental contact while riding and also if the bike falls over.

Available from Q3/2020.





**ENGINE SPOILER**

The elegant three-part engine spoiler made of shatterproof and UV-resistant plastic ensures an individual sporty look. The side sections, painted in Granite grey metallic and Racing red create a striking visual accent.

Available from Q3/2020.

1 Engine spoiler, Granite grey metallic

NEW

2 Engine spoiler, Racing red

NEW



# ERGONOMICS & COMFORT

**WINDSCREENS**

The tinted windscreen emphasises the sporty look of the motorcycle. The scratch-resistant coating ensures long-term unimpeded visibility. The dimensions and shape are identical to those of the standard version, which means that the windscreen also offers good wind and weather protection.

The Sport windscreen in clear glass is approx. 20mm shorter than the standard windscreen and highlights the sporty look of the bike. The screen was developed in the BMW wind tunnel and offers good wind and weather protection even at higher speeds. The scratch-resistant coating ensures long-term unimpeded visibility.

**Tinted windscreen  
(not shown)**

1 Sport windscreen

NEW

2 Sport windscreen, tinted

NEW



**HEATED GRIP RETROFIT SET  
(NOT SHOWN)**

No more cold hands: This is ensured by the electric heating grips with multi-stage control. This increases comfort and provides more safety, because with warm hands and more feeling in the fingers, the vehicle can simply be controlled better. The heated grip is conveniently operated via a combination switch on the handlebars.

For more detailed information, contact your authorised BMW Motorrad Retailer or go online at [bmw-motorrad.com](http://bmw-motorrad.com). To be fitted and/or enabled in a specialist workshop, ideally at your authorised BMW Motorrad Retailer.

**CRUISE CONTROL RETROFIT SET  
(NOT SHOWN)**

The electronic cruise control can be activated from 30 km/h and keeps the riding speed constant. This makes it possible to enjoy longer motorway stretches in a relaxed style. The function is deactivated on braking, and the selected speed is automatically adopted after activating the Resume button.

**LOW-SLUNG  
(NOT SHOWN)**

NEW

The changes in the chassis resulting from the lowered suspension reduce the vehicle height and the seat height. This means that even smaller riders can enjoy improved stability and have better control over their machine when manoeuvring.



SEATS

The comfort seat with additional padding offers noticeable benefits in seating comfort and therefore even more carefree miles, especially for tall riders. The seat height is higher compared to the standard seat. This means that even long daily stages can be enjoyed in a relaxed style and without fatigue.

The low seat makes it easier to get on and off and improves ground accessibility. Many riders feel safer thanks to the reduced seat height, because they can manoeuvre and control their motorcycle more easily. The high-quality surface material in black corresponds to the standard equipment.

1 Comfort seat

NEW



2 Low seat

NEW



CENTRE STAND

NEW

The stable centre stand ensures a safe stand for the motorcycle even on slopes and offers advantages, for example, when refuelling, mounting cases and topcases or checking tyre pressure. The motorcycle also takes up less space when parked upright.



SHIFT ASSISTANT PRO  
(NOT SHOWN)

The shift assistant Pro allows shifting up and down in almost all load ranges and engine speed ranges without clutch control. The assistant thus ensures noticeably reduced shifting times, a relief of the clutch hand and thus more comfort, dynamics and riding pleasure.

To be fitted and/or enabled in a specialist workshop, ideally at your authorised BMW Motorrad Retailer.

NAVIGATION  
& COMMUNICATION

BMW MOTORRAD NAVIGATOR VI

With the multifunctional Navigator VI, route planning becomes child's play. The system with 16 GB flash memory and a five-inch touch screen always shows the right way. Thanks to the circular polarisation filter (CPOL), the waterproof display is easy to read even in direct sunlight. The high-resolution screen in a casing similar to a smartphone provides all the essential information and ensures that you can see the big picture required in every situation. Numerous additional functions make planning and touring an exciting experience. Plan your routes can be created according to your personal preferences and enjoy driving on winding and quiet side roads. In unknown terrain, the "round trip" option is a good choice as it reliably guides the rider at the end of the tour back to the starting point. The Bluetooth connection to the BMW Motorrad communication system and the optional Smartphone Link app enable multimedia on the go: navigation announcements, telephone calls and music streaming as well as the retrieval of weather forecasts or traffic jam information are no problem. Navigation preparation adds further functions such as "My Motorcycle", and the multi-controller on the handlebars offers an alternative control option. Choose the pre-installed map data, and you will always be up to date thanks to lifelong, free map updates.

Note the differences in national-market versions. Only available in conjunction with OE navigation preparation.  
Not available in conjunction with the smartphone cradle holder or handlebar extension.  
To be fitted and/or enabled in a specialist workshop, ideally at your authorised BMW Motorrad Retailer.



NAVIGATION PREPARATION RETROFIT SET  
(NOT SHOWN)

The retrofit set includes navigation preparation with Multi-Controller, holder and Mount Cradle for the navigation device. This allows the BMW Navigator to be neatly integrated into the cockpit in the rider's direct field of vision. The system is secured against theft and can be operated via the Multi-Controller on the handlebars.

BMW MOTORRAD SMARTPHONE CRADLE

BMW Motorrad's robust smartphone cradle provides a safe and protected place for your smartphone. This means that useful functions such as navigation information and online information can also be used while you are on the move. Thanks to the handy charging function, your smartphone is also always ready for action on extended bike tours.

Only in combination with bracket for BMW Motorrad navigation devices.  
Not available in conjunction with preparation for navigation device or handlebar riser.  
To be fitted and/or enabled in a specialist workshop, ideally at your authorised BMW Motorrad Retailer.





# SAFETY

## HAND PROTECTORS

NEW



The hand protector, made of impact-resistant and UV-resistant plastic, also protects the operating elements against branches and stone chips while riding off-road, and is aerodynamically tailored to the vehicle. On the road, the wind and weather protection offered by the protectors is also impressive: hands and fingers stay longer dry and warm even at low temperatures.

To be fitted and/or enabled in a specialist workshop, ideally at your authorised BMW Motorrad Retailer.

## ENGINE PROTECTION BAR

NEW

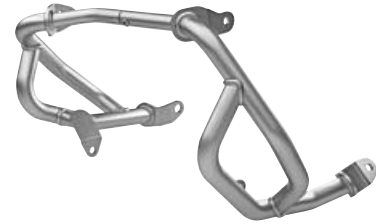

The electropolished stainless steel sturdy engine protection bar reliably protects the engine housing against damage from the bike falling over or in the event of a fall without compromising the lean angle. It blends perfectly with the bike's design.

## LED ADDITIONAL HEADLIGHTS

The powerful LED additional headlights extend the illumination to ensure the required vision in poor visibility conditions. Thus they perfectly complement the main headlight. LED technology ensures virtually wear-free operation.

To be fitted and/or enabled in a specialist workshop, ideally at your authorised BMW Motorrad Retailer. The additional headlights are approved for use as fog lights, and may only be used in poor weather conditions. Country-specific road traffic regulations apply.



## PROTECTIVE GLASS FOR 6.5-INCH TFT DISPLAY

The protective glass reliably protects the 6.5-inch TFT display from dirt, flying stones and damage. The tempered glass has an anti-glare and anti-reflective surface, so that it is still easy to read the TFT display. With BMW Motorrad inscription.



## ACTIVATION CODE DYNAMIC ENGINE BRAKE CONTROL (NOT SHOWN)

NEW

The MSR engine drag torque control reliably prevents unstable riding conditions that can occur during overrun mode or when shifting down due to excessive slip on the rear wheel. In this case, MSR increases the engine torque by opening the throttle valves to reduce slip and stabilise the motorcycle.

## ANTI-THEFT ALARM RETROFIT SET (NOT SHOWN)

NEW

Strong protection from theft: If the motorcycle is moved or struck violently, the anti-theft alarm system responds with a clearly audible signal and a flashing warning light. The acoustic and optical warning will draw the attention of passers-by quickly. The alarm system is activated automatically when the ignition is switched off.

Note the differences in national-market versions. To be fitted and/or enabled in a specialist workshop, ideally at your authorised BMW Motorrad Retailer.

## TYRE PRESSURE CONTROL RETROFIT SET (NOT SHOWN)

NEW

Tyre Pressure Control (TPC) with all functions can be retrofitted by installing the control unit. TPC provides reliable information about the current tyre pressure and warns the rider about pressure loss at an early stage. The corresponding notifications and instructions are provided by the on-board computer in the cockpit.

To be fitted and/or enabled in a specialist workshop, ideally at your authorised BMW Motorrad Retailer.

# MAINTENANCE & TECHNOLOGY

## OUTPUT REDUCTION 35 kW / 48 HP (NOT SHOWN)

NEW

The power reduction retrofit to 35 kW (48 hp) is an attractive option for beginners and returning riders. This leaves nothing to be desired when it comes to riding pleasure and feeling. The engine can be brought back to its full power later on, if desired. The power reduction is carried out by means of an enabling code.

Original BMW Motorrad equipment is available from your authorised BMW Motorrad Retailer.

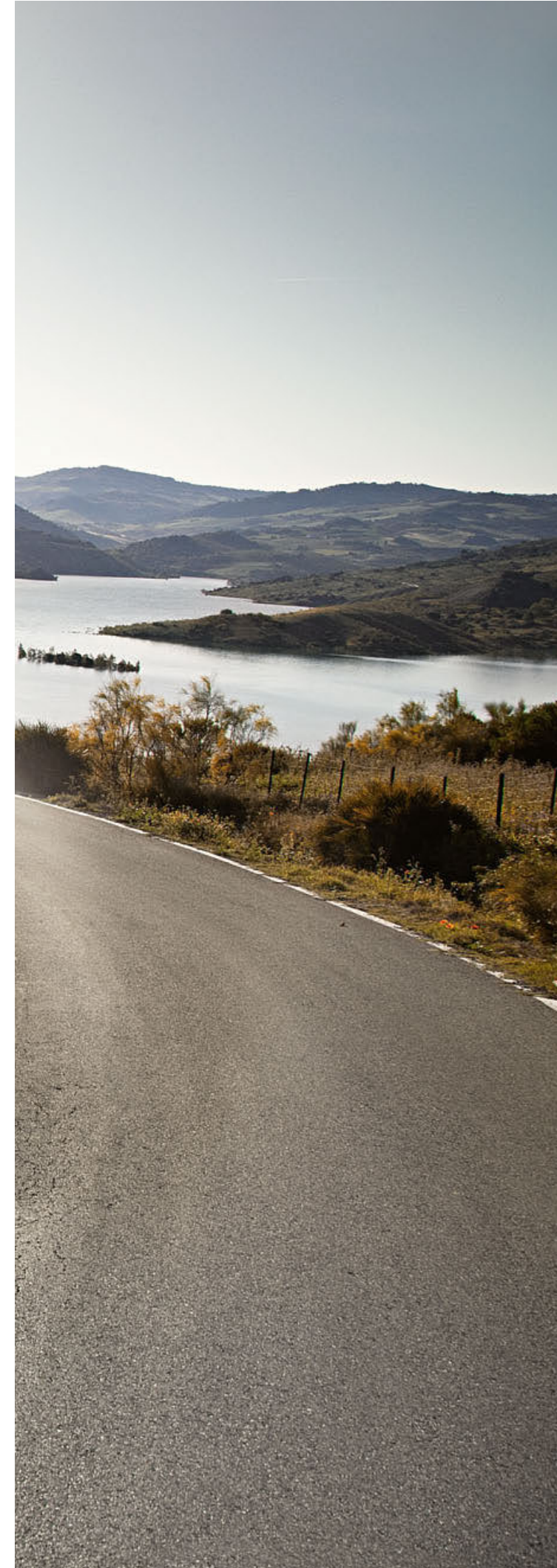



# ACCESSORIES FOR BMW S 1000 XR

Model code 0D03, 0D13



## HP PARTS

### HP SPORT SILENCER



The HP sports silencer is completely made of titanium and its excellent sound makes every ride a sporty experience. Thanks to its lightweight titanium design, the end cap and the large carbon heat shield, it weighs 0.5 kg less than the standard silencer.

Mounting instructions are available from your authorised BMW Motorrad Retailer.

### HP AXLE PROTECTORS



The HP axle protectors for the front axle are made of highly abrasion-resistant plastic. They feature the BMW and HP inscription and protect the front fork from scratches if the bike falls or tips over.

Mounting instructions are available from your authorised BMW Motorrad Retailer.

### HP FOOTRESTS FOR RIDER AND PASSENGER

The HP rider footrest system provides optimum ergonomics and sportiness thanks to its dynamic look and many adjustment options. It is milled from a high-strength aluminium alloy, is particularly lightweight and offers optimum corrosion protection thanks to its three-colour anodisation.

The milled HP passenger footrest is perfectly matched in shape and material to the corresponding HP rider footrests.

To be fitted and/or enabled in a specialist workshop, ideally at your authorised BMW Motorrad Retailer.

#### 1 HP rider footrest system, right



#### 2 HP rider footrest system, left



#### 3 HP passenger footrest



### HP MILLED BRAKE AND CLUTCH LEVERS

The ergonomically optimised HP clutch lever made of grey anodised aluminium is adjustable and underlines the sportiness of the motorcycle.

The HP brake lever made of grey anodised aluminium emphasises the sportiness of the bike and can be ergonomically adjusted to the hand width in five steps.

To be fitted and/or enabled in a specialist workshop, ideally at your authorised BMW Motorrad Retailer.

#### 1 HP milled clutch lever



#### 2 HP milled brake lever



### PRO GEAR-SHIFT ASSIST

The Shift Assistant Pro makes it easy to shift up and down without actuating the clutch.

To be fitted and/or enabled in a specialist workshop, ideally at your authorised BMW Motorrad Retailer.



Original BMW Motorrad equipment is available from your authorised BMW Motorrad Retailer.



HP ENGINE PROTECTORS



The HP engine protector offers improved protection against damage to engine components with its replaceable plastic slip pads.

To be fitted and/or enabled in a specialist workshop, ideally at your authorised BMW Motorrad Retailer. Not available in conjunction with engine protection bar.

HP FORGED WHEELS



The black anodised HP forged front wheel offers improved handling and suspension characteristics thanks to its weight advantage.

The black anodised rear HP forged wheel (not shown) is lighter than the standard wheel and provides a noticeable increase in riding dynamics in fast S-bends.

To be fitted and/or enabled in a specialist workshop, ideally at your authorised BMW Motorrad Retailer.

HP CARBON BOLT-ON PARTS

Superlative performance is a given with these bolt-on parts. They're elegant, exclusive and durable – each one a masterpiece in its own right. And if perfection's what you're after, you've hit the jackpot here because they're made of carbon, the ultimate lightweight material. An unbeatable combination of stylish looks and technical expertise.

**Small mounting parts included.**

For more detailed information, contact your authorised BMW Motorrad Retailer or go online at [bmw-motorrad.com](http://bmw-motorrad.com).

1 HP carbon front wheel cover



2 HP carbon rear wheel cover



3 HP carbon cockpit fairing



4 HP carbon fuel filler cap



5 HP carbon pinion cover



6 HP carbon cover for number plate carrier



HP CHAIN TENSIONER



The HP chain tensioner offers high-precision adjustment of chain tension and rear-wheel alignment. It's securely attached to the swing arm, which makes it easier to fit the rear wheel.

HP ASSEMBLY STAND MOUNTING



The high-quality HP assembly stand mounting is made of high-strength, CNC-milled aluminium and enables the use of the rear Sport assembly stand. The existing rollers prevent the assembly stands from slipping and thus protect the motorcycle from possible scratches.

# STORAGE

TOURING CASES

With a volume of approx. 31 litres on each side, the high-quality hard shell touring case offers ample space for luggage or a motorcycle helmet. The splashproof case with painted lid can be locked and is the perfect travel companion for short or longer tours.

1 Touring case, Racing red



2 Touring case, Light white



3 Touring case, Black storm metallic



Original BMW Motorrad equipment is available from your authorised BMW Motorrad Retailer.



**LINERS FOR TOURING CASES**

The matching liner for the touring case gets the luggage organised and facilitates loading and unloading. The carry handle and shoulder strap make the bag easy to access and transport. A three-sided all-round two-way zip allows quick access to the contents.



**CASE HOLDER**

The touring case can be easily and securely attached to the sturdy black painted steel case holder.

Also available as an equipment option.



**SMALL TOPCASE AND BACKREST PAD**

The waterproof topcase has a capacity of 30l and a maximum load of 5 kg – perfect for a helmet, for example. The lid has the same paintwork as the touring case and is equipped with a soft-close mechanism. A backrest pad and central locking functionality are also available upon request.

1 Small topcase, Racing red



2 Small topcase, light white



3 Small topcase, Black storm metallic



4 Small topcase, Granite grey metallic matt



**LINER FOR SMALL TOPCASE**

The matching tailored liner for the topcase gets the luggage organised and facilitates loading and unloading. The carry handle and shoulder strap make the bag easy to access and transport. The practical details include the outside pocket and the three-sided zipper.



**LARGE TOPCASE AND BACKREST PAD**

This waterproof topcase offers ample space for up to two helmets with a volume of 49 litres. The lid optionally available in only primed, Granite grey metallic matt, Light white, Black storm metallic or Racing red (not shown) allows customised paintwork in the desired or vehicle colour. Practical options are the matching liner or backrest pad for the passenger.

To be fitted and/or enabled in a specialist workshop, ideally at your authorised BMW Motorrad Retailer.

1 Large topcase, Granite grey metallic matt



2 Large topcase, Light white



3 Large topcase, Black storm metallic



**LINER FOR LARGE TOPCASE**

The matching liner for the large topcase gets the luggage organised and facilitates loading and unloading. The carry handle and shoulder strap make the bag easy to access and transport. Practical details include two external patch pockets and the three-sided all-round zipper.

**LUGGAGE GRID AND TOPCASE HOLDER**

The sturdy, stylish luggage carrier is ideal for reliably securing the topcase. In addition, it serves as a convenient handle for the passenger and is also ideal for using as a pushing aid when jacking up and manoeuvring.



**LED INDICATORS**

A shining example: The beautifully designed LED indicators with white turn indicator glass convince with their slim design and modern lighting technology. They respond much faster than incandescent lamps and are virtually wear-free. This provides a clear safety advantage in road traffic.

To be fitted and/or enabled in a specialist workshop, ideally at your authorised BMW Motorrad Retailer.





**TANK BAG AND MAP POCKET FOR TANK BAG**

The tank bag is made of durable PU-coated polyester fabric with a waterproof main compartment and strap fastening and can be expanded from 10 litres to 15 litres. The water-repellent outside pocket offers additional stowage space. The carry handle and the detachable shoulder strap are further practical features.

The removable and waterproof A4 map pocket ideally complements the tank bag.

1 Tank bag



2 Waterproof map pocket for tank bag



# ERGONOMICS & COMFORT

**TINTED WINDSCREEN**



The tinted windscreen emphasises the sporty look of the motorcycle. The special coating also permanently prevents scratches.

To be fitted and/or enabled in a specialist workshop, ideally at your authorised BMW Motorrad Retailer.

**CRUISE CONTROL RETROFIT SET**



Also available as an equipment option.

To be fitted and/or enabled in a specialist workshop, ideally at your authorised BMW Motorrad Retailer. For more detailed information, contact your authorised BMW Motorrad Retailer or go online at [bmw-motorrad.com](http://bmw-motorrad.com).

**SEATS**

All seats are available in two heights, for the perfect knee angle.

Specially developed for the BMW S 1000 XR and finished to the highest standards, the padded HP sport seat offers increased comfort on longer journeys.

- 1 Seat height: 855 mm; step length: 1,925 mm
- 2 Seat height: 840 mm; inner leg curve: 1,894 mm
- 3 Seat height: 840 mm; inner leg curve: 1,894 mm
- 4 Also available as optional equipment  
Seat height: 820 mm; inner leg curve: 1,860 mm

1 HP sport seat, high



2 HP sport seat



3 Seat



4 Low seat



**CENTRE STAND**



The stable centre stand ensures a safe stand for the motorcycle even on slopes and offers advantages, for example, when refuelling, mounting cases and topcases or checking tyre pressure. The motorcycle also takes up less space when parked upright.

To be fitted and/or enabled in a specialist workshop, ideally at your authorised BMW Motorrad Retailer.

**HEATED GRIPS**



Comfort meets safety. The practical heated grips keep hands pleasantly warm even on cold days and also more responsive. The grip heating controlled by the on-board computer continuously detects the outside temperature via sensors and adjusts the heat output.

To be fitted and/or enabled in a specialist workshop, ideally at your authorised BMW Motorrad Retailer. For more detailed information, contact your authorised BMW Motorrad Retailer or go online at [bmw-motorrad.com](http://bmw-motorrad.com).



# NAVIGATION & COMMUNICATION

## BMW MOTORRAD NAVIGATOR VI

With the multifunctional Navigator VI, route planning becomes child's play. The system with 16 GB flash memory and a five-inch touch screen always shows the right way. Thanks to the circular polarisation filter (CPOL), the waterproof display is easy to read even in direct sunlight. The high-resolution screen in a casing similar to a smartphone provides all the essential information and ensures that you can see the big picture required in every situation. Numerous additional functions make planning and touring an exciting experience. Plan your routes can be created according to your personal preferences and enjoy driving on winding and quiet side roads. In unknown terrain, the "round trip" option is a good choice as it reliably guides the rider at the end of the tour back to the starting point. The Bluetooth connection to the BMW Motorrad communication system and the optional Smartphone Link app enable multimedia on the go: navigation announcements, telephone calls and music streaming as well as the retrieval of weather forecasts or traffic jam information are no problem. Navigation preparation adds further functions such as "My Motorcycle", and the multi-controller on the handlebars offers an alternative control option. Choose the pre-installed map data, and you will always be up to date thanks to lifelong, free map updates.



For more detailed information, contact your authorised BMW Motorrad Retailer or go online at [bmw-motorrad.com](http://bmw-motorrad.com).

# SAFETY

## HAND PROTECTORS

This tough hand protector is made of shatter-proof, UV-resistant plastic and provides effective protection for the hands against low branches and flying stones. Also available as optional equipment.



## ENGINE PROTECTION BARS

The stainless steel, electropolished engine protection bars provide effective protection for the sides of the engine, without compromising the lean angle.

To be fitted and/or enabled in a specialist workshop, and ideally at your authorised BMW Motorrad Retailer. Not available in conjunction with engine protectors. Small mounting parts are not included. For more detailed information, contact your authorised BMW Motorrad Retailer or go online at [bmw-motorrad.com](http://bmw-motorrad.com).



## ANTI-THEFT ALARM SYSTEM (NOT SHOWN)

The anti-theft alarm system reacts to changes in position and vibrations with a clearly audible signal and a flashing warning lights system. Thanks to the warning, passers-by quickly become aware. The system is conveniently activated by remote control.

To be fitted and/or enabled in a specialist workshop, and ideally at your authorised BMW Motorrad Retailer.

## ABS PRO ENABLING CODE (NOT SHOWN)

The BMW Motorrad ABS Pro is available in all riding modes and also adapts the ABS control to the motorcycle's lean angle. The system is perfectly adapted to the selected riding mode and ensures optimum braking performance even in bends. The motorcycle does not right itself and remains on course.





# ACCESSORIES FOR BMW R 1250 GS



## HP PARTS

### HP SPORTS SILENCER



A top-class feature for top quality sound. The sleek, high-quality titanium slip-on silencer with carbon end-cap delivers a powerful rumble. In addition, the sports silencer developed with Akrapovič is weight-optimised compared to the standard silencer.

Not approved for the USA.

### HP HAND LEVER, ADJUSTABLE



The CNC-milled HP hand levers made of anodised aluminium combine functionality and aesthetics. The grip width can be adjusted in five steps (brake lever) or three steps (clutch lever) using a setting screw and thus adapted to individual requirements. The look with HP logo also emphasises the bike's sportiness.

### HP COVERS FOR EXPANSION TANKS



The HP cover for expansion tanks made of anodised aluminium also adds to the bike's sporty character. The high-quality milled cover with HP branding emphasises the high-performance claim and also provides for an attractive customisation of the bike.

### HP MIRRORS



The high-quality HP mirrors are made of milled aluminium and emphasise the sporty character of the bike. The low-vibration construction and aerodynamic shape ensure excellent visibility. The attractive design with BMW Motorrad inscription also creates a strong individualisation effect.

### HP ENGINE HOUSING COVER, FRONT



The HP engine housing cover made of anodised aluminium also adds to the bike's sporty character. The high-quality milled cover and HP branding emphasise the high-performance standard and also guarantee an attractive customisation of the bike.

### HP FOOT LEVER AND RIDER FOOTRESTS, ADJUSTABLE



The HP rider footrests with plastic footplates are adjustable in three positions and provide maximum comfort and surefootedness on and off-road. The high-quality milled parts made of anodised aluminium provide more control especially when riding in a standing position. The exclusive look with HP logo also emphasises the bike's performance-based character.

The milled HP foot levers made of anodised aluminium are adjustable and come in sporty HP blue / silver / black. With the right set up, the foot levers can also be operated better and more sensitively when riding while standing up during off-road use. The exclusive look with HP logo also emphasises the bike's performance-based character.

### HP CYLINDER HEAD COVERS



The HP cylinder head covers made of anodised aluminium give the opposed-twin engine an attractive appearance. The high-quality milled covers and HP branding highlight the motorcycle's sporty character. The HP oil filler plug perfectly matches the cylinder head covers.



# STORAGE

## ALUMINIUM CASES

The perfect solution for touring fans who place the highest demands on themselves and their equipment: the aluminium case for mounting on the left-hand side offers 44 litres of storage space. The aluminium case for mounting on the right-hand side offers 36 litres of storage space. This robust piece of transport equipment is dust- and waterproof. Many practical details impress even under extreme conditions.

Not available in conjunction with LED indicators at the rear with short base TNR 8 522 499; install LED indicators with long base TNR 8 522 500 if necessary. For information on individual speed and load restrictions, please refer to the instruction booklet.

1 Aluminium case



2 Aluminium case, black



## ALUMINIUM TOPCASE

The waterproof topcase has a capacity of 32 litres and lashing eyes for securing additional luggage. And with the optional backrest pad added, it provides increased comfort for the passenger.

For information on speed and load limitations, please refer to the instruction booklet.

1 Aluminium topcase, 32l



2 Aluminium topcase, black, 32l



3 Aluminium backrest pad for aluminium topcase



## CASE HOLDER AND TOPCASE CARRIER FOR ALUMINIUM CASES

The aluminium side cases and the Atacama side bags can be easily and securely attached to the sturdy case rack made of polished or black powder-coated stainless steel. In addition to a typical Enduro appearance, the case rack also serves as a traction point for off-road use.

The Atacama luggage roll or other pieces of luggage can be attached to the sturdy topcase carrier made of powder-coated stainless steel.

### 1 & 2

Not available in conjunction with Rallye seat with luggage plate. Only available in conjunction with part number 77 30 8 546 226 (cover kit for holes for grab handles) if the standard passenger grab handles have been removed.

### 2 & 4

When used with aluminium cases, the black coating rubs off at the contact points.

1 Case holder for aluminium cases



2 Black case holder for aluminium cases



3 Topcase carrier for aluminium topcases



4 Black topcase carrier for aluminium topcases



## CARRY HANDLE FOR ALUMINIUM CASE / TOPCASE

Convenient and functional: The practical carry handles for aluminium cases and topcases make it easy to transport the luggage to and from the bike. If the cases are mounted, additional luggage can also be attached to the handles.



## LINER FOR ALUMINIUM CASES AND ALUMINIUM TOPCASES

The waterproof liner for the aluminium case gets the luggage organised and facilitates loading and unloading. The carry handle and shoulder strap make the bag easy to access and transport. Alternatively, the sturdy bag can also be attached to the outside of the case, creating additional storage space.





**LUGGAGE COMPARTMENT SEPARATING NET FOR ALUMINIUM CASES**

The luggage net for aluminium cases and topcases creates more order and makes it easier to access frequently used items. The highly flexible net is attached to the inside of the lid and ensures that luggage such as raincoats, folding backpacks, toiletry bags and sneakers are always at hand when the case is opened.



**ATACAMA LUGGAGE SYSTEM**

The Atacama side bags convince with clever details and a combined storage volume of 60 litres. In addition to the waterproof liners, various storage compartments provide additional space. Quick-release fasteners for easy mounting on the motorcycle and sturdy carry handles ensure a secure hold and extremely practical handling.

The Atacama side bags and roll bag and other pieces of luggage or helmets can be secured to the motorcycle using the lockable tension straps with steel core.

**1**  
Only available in conjunction with case rack for aluminium cases. For information on speed and load restrictions, please refer to the instruction booklet.

**3**  
For information on speed and load limitations, please refer to the instruction booklet. Rubs off at the contact points.

The extremely durable Atacama luggage roll sports many clever details and an enormous storage volume of 40 litres.

**1 Atacama side bags**



**2 Tensioning straps for Atacama side bags, lockable**



**3 Atacama luggage roll, 40l**



**4 Tensioning strap for Atacama roll bag, lockable**



**VARIABLE CASES**

With its patented adjustment mechanism, the variable case offers stowage space of 30 to 39 litres (left) and/or 20 to 29 litres (right). The adjustable volume offers benefits, especially in city traffic, as the width of the case can be reduced at the same time. Naturally the variable case is waterproof and also suitable for off-road use.

The variable cases can be easily and securely attached to the sturdy case racks on both sides of the motorcycle. The racks are perfectly integrated into the overall appearance of the motorcycle.

**1 Variable case**



**3 Case holders for variable cases**



**4 Case holders for black variable cases**



**ALUMINIUM TOPCASE AND BACKREST PAD**

The variable topcase with its patented adjustment mechanism offers a variable volume from 25 to 35 litres. The variable topcase, made of robust plastic, is waterproof, suitable for off-road use and has a large GS inscription.

The backrest pad for the variable topcase offers the passenger more comfort both on short trips and on long tours.

**1 Variable topcase**



**2 Backrest pad**





**LINER FOR VARIABLE CASE AND TOPCASE**



The liners for the variable cases and the variable topcase get the luggage organised and facilitate loading and unloading. The bag is quick to hand and easy to carry thanks to the carry handle and shoulder strap. Practical details include the mesh partition with a zippered compartment in the lid and the volume which can be varied by an all-round zipper.

**LUGGAGE PLATE FOR PASSENGER SEAT**



The luggage plate made of black painted plastic replaces the passenger seat and offers the ideal basis for safely transporting luggage. In combination with the variable cases, the result is a wide, flat packing surface on which even larger objects can be secured close to the vehicle's centre of gravity.

Not available in conjunction with Rallye seat with luggage plate. Only available in conjunction with part number 77 30 8 546 226 (cover kit for holes for grab handles) if the standard passenger grab handles have been removed.

**TRIMS FOR GRAB HANDLE HOLES**



The trims for grab handle holes cover the open holes when the passenger grab handles are removed and thus protect against dirt. They also create a typical Enduro appearance.

**LARGE TOPCASE, 49L AND BACKREST PAD**

This waterproof topcase offers ample space for up to two helmets with a volume of 49 litres. The lid optionally available in only primed, Granite grey metallic matt or Racing red allows customised paintwork in the desired or vehicle colour. Practical options are the matching liner or backrest pad for the passenger.

Only available in conjunction with luggage carrier and topcase carrier.

**1 Large topcase, 49l**



**2 Backrest pad for large topcase**



**LINER FOR LARGE TOPCASE**

The matching liner for the large topcase gets the luggage organised and facilitates loading and unloading. The carry handle and shoulder strap make the bag easy to access and transport. Practical details include two external patch pockets and the three-sided all-round zipper.



**TANK BAG AND MAP POCKET**

The tank bag, made of durable PVC-coated polyester fabric with a waterproof main compartment and belt attachment, offers intelligent details such as the cable duct and fastening loops for the additional waterproof DIN A4 map pocket; its volume can be expanded from 11 to 15 litres as required. Extra space is available with the exterior pocket.

The small tank bag made of PVC-coated polyester fabric with belt attachment is the ideal companion for short trips. The waterproof main compartment with an liner offers intelligent details such as the cable duct and fastening loops for the waterproof A4 map pocket and has a volume of 8 litres.

The removable and waterproof A4 map pocket ideally complements the tank bag.

For information on speed and load restrictions, please refer to the instruction booklet.

**1 Large tank bag, 11-15l**



**2 Small tank bag, 8l**



**3 Map pocket for tank bag**



**BAG FOR PASSENGER SEAT, 14-18 L**

With a waterproof main compartment which can be expanded from 14 to 18 litres, this durable bag for the passenger seat offers enough storage space for the daily ride to work or for day trips. The three-sided zip fastener allows quick access, while the functional carrying handle facilitates transport.

For information on speed and load restrictions, please refer to the instruction booklet.



**BAG FOR FRAME**

The lined pocket made of PVC-coated polyester fabric is attached to the frame below the rider's seat and does not restrict freedom of movement. Now smaller items are also always on board while on the road. The water-repellent zip fastener with non-slip zipper allows quick access.



**ADDITIONAL BAG UNDER LUGGAGE CARRIER**

The small and practical bag made of durable polyester fabric with a PVC coating creates additional stowage space under the luggage carrier. This means that smaller items that the rider does not want to do without on the road are always on board.

Not available in conjunction with the aluminium luggage carrier.





**POCKET FOR WIND DEFLECTOR**

The high-quality pockets made of PVC-coated polyester fabric are attached behind the trim panel and thus allow quick access to the contents. The lined storage space is particularly suitable for smaller items such as smartphones up to 5 inches, which are safe and protected there.



**TOPCASE CARRIER FOR LUGGAGE CARRIER (NOT SHOWN)**

The topcase carrier is the ideal link between the BMW topcase and the motorcycle. It is made of electropolished, stainless steel and allows the variable topcase to be mounted easily. In addition, the carrier offers additional attachment points for lashing luggage.



DESIGN

**OPTION 719 CLASSIC HAND LEVERS, ADJUSTABLE**



The Classic hand levers of the exclusive Option 719 are milled from an anodised aluminium alloy. The grip width can be adjusted in five steps (brake lever) or three steps (clutch lever) using a setting screw and thus adapted to individual requirements. The high-quality Billet Pack parts with Option 719 branding add value to the bike.

To be fitted and/or enabled in a specialist workshop, and ideally at your authorised BMW Motorrad Retailer.

**OPTION 719 CLASSIC COVERS FOR EXPANSION TANKS**



The Option 719 Classic covers for expansion tanks set an elegant, design highlight with their silver-coloured appearance. The milled cover made of anodised aluminium bears the inscription "Option 719". Together with the other special parts of Option 719 an exclusive customisation effect is created.

**OPTION 719 CLASSIC ENGINE HOUSING COVER, FRONT**



The Option 719 Classic engine housing cover sets an elegant, design highlight with its silver-coloured look. The high-quality milled cover made of anodised aluminium bears the "Option 719" inscription. Together with the other special parts of Option 719 an exclusive customisation effect is created.

To be fitted and/or enabled in a specialist workshop, and ideally at your authorised BMW Motorrad Retailer.

**OPTION 719 ADJUSTABLE CLASSIC RIDER FOOTRESTS AND FOOT LEVERS**



The Classic aluminium rider footrests with plastic footplate are adjustable in three positions and provide maximum comfort and surefootedness on and off-road. The high-quality milled parts of the exclusive Option 719 provide additional stability and even better control of the motorcycle when riding in a standing position, especially off-road.

The exclusive Option 719 Classic foot levers are milled from anodised aluminium and are individually adjustable. With the right set up, the foot levers can also be operated better and more sensitively when riding while standing up during off-road use. The high-quality Billet Pack parts with Option 719 branding add value to the bike.

To be fitted and/or enabled in a specialist workshop, and ideally at your authorised BMW Motorrad Retailer.

**OPTION 719 CLASSIC CYLINDER HEAD COVERS**



The Classic cylinder head covers of the exclusive Option 719 add design highlights with their silver-coloured appearance. The high-quality milled covers made of anodised aluminium bring the opposed-twin engine into the spotlight. The exclusive special parts bear the inscription "Option 719" and emphasise the high-quality character of the bike.

To be fitted and/or enabled in a specialist workshop, and ideally at your authorised BMW Motorrad Retailer.



OPTION 719 CLASSIC OIL FILLER PLUG



The safety screw for the oil filler neck is locked using a special Allen® key, preventing theft of the cover. At the same time, unauthorised access and contamination of the oil by foreign substances is prevented. The high-quality aluminium lock has a BMW Boxer inscription.

OPTION 719 SILVER MIRRORS



The Option 719 silver-coloured mirrors are made of milled aluminium and highlight the high-quality character of the bike. The low-vibration construction and aerodynamic shape ensure excellent visibility. The attractive design also creates a strong individualisation effect.

CHROME-PLATED EXHAUST MANIFOLD

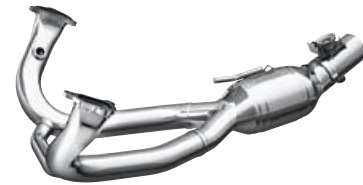

The chrome-plated exhaust manifold further enhances the motorcycle's appearance. This elegant manifold can be combined with the standard silencer or the HP sport silencer.

CHROME-PLATED REAR SILENCER



The high-quality chrome-plated rear silencer perfectly harmonises with other motorcycle chrome applications.

To be fitted and/or enabled in a specialist workshop, and ideally at your authorised BMW Motorrad Retailer.

BLACK REAR FOOTRESTS BRACKET



To be fitted and/or enabled in a specialist workshop, and ideally at your authorised BMW Motorrad Retailer.

REAR-WHEEL COVER



The milled aluminium rear-wheel cover emphasises the dynamic design of the bike. The black anodised covers with BMW Motorrad inscription and a diameter of 62 mm enhance the motorcycle visually and technically.

"STYLE" BLACK RADIATOR COWLS



The stainless steel "Style" radiator cowls are not only resistant to detergents due to their black coating, but also their colour does not fade even in direct sunlight. Together with the other optional equipment in Black, they emphasise the dynamic character of the bike.

LED INDICATORS



A shining example: the elegant LED indicators with white indicator glass match the motorcycle's look and also enhance it. Moreover, they impress with their sleek design and modern lighting technology. For example, they respond faster than classic bulbs and are virtually wear-free.

Note the differences in national-market versions. To be fitted and/or enabled in a specialist workshop, and ideally at your authorised BMW Motorrad Retailer.

EXTENDED FRONT-WHEEL COVER



The larger front-wheel cover emphasises the BMW R 1250 GS's Enduro style and offers improved spray protection.





# ERGONOMICS & COMFORT

## WINDSCREENS

The high-quality windscreen with its dark tint impressively underlines the motorcycle's sporty look. It has the same dimensions as the standard windscreen and, thanks to its scratch-resistant coating on both sides, ensures great, lasting visibility in all conditions.

The Rallye windscreen was specially developed for off-road use. It is small enough to give the rider a clear view of the terrain and yet offers protection and freedom of movement when riding in a standing position. The Enduro-specific appearance underlines the machine's off-road potential.

**1**  
Note the differences in national-market versions.  
To be fitted and/or enabled in a specialist workshop, and ideally at your authorised BMW Motorrad Retailer.

1 Windscreen, tinted



2 Rallye windscreen, tinted



3 Rallye screen



## EXCLUSIVE RIDER AND PASSENGER SEAT

Thanks to the smooth but very dimensionally stable soft-touch insert, the Exclusive rider's seat offers a noticeable improvement in seating comfort even on longer journeys. The high-quality impression invites the riders to get on the bike as soon as they see it.

The Exclusive rider's seat with the soft-touch insert is 20 mm higher and offers particularly tall riders noticeably better seating comfort.

The lower Exclusive rider's seat makes getting on and off the bike easier and offers a noticeable improvement in seating comfort thanks to the soft-touch insert.

Thanks to the smooth but very dimensionally stable soft-touch insert, the Exclusive passenger seat offers a noticeable improvement in seating comfort and invites the passenger to get on. The seat is also available in a narrow design.

- 1 Exclusive high rider seat**  
Seat height: 870 mm/890 mm;  
step length: 1,910 mm/1,950 mm  
Only available in conjunction with appropriate passenger or rider seat.
- 2 Exclusive low rider seat**  
Seat height: 820 mm/840 mm;  
step length: 1,820 mm/1,860 mm  
Only available in conjunction with appropriate passenger or rider seat.
- 3 Exclusive rider seat**  
Seat height: 850 mm/870 mm;  
step length: 1,870 mm/1,910 mm  
Only available in conjunction with appropriate passenger or rider seat.
- 4** Only available in conjunction with appropriate passenger or rider seat.

1 Exclusive rider seat, high



2 Exclusive rider seat, low



3 Exclusive rider seat



4 Exclusive passenger seat





RIDER AND PASSENGER SEAT

The rider seat in black is 20mm higher and offers particularly tall riders noticeably better seating comfort. 20mm lower than the standard version, this black rider's seat makes climbing on and off easier and keeps the ground within easy reach.

Thanks to an additional soft-touch foam layer, the 20mm higher comfort seat offers a noticeable increase in seating comfort and thus even more carefree kilometres. The soft, structured cover and exclusive design ensure a high-quality look.

The lower Comfort rider seat in an exclusive design offers a noticeable improvement in seating comfort and makes getting on and off the bike easier.

The comfort passenger seat offers a noticeable improvement in seating comfort thanks to an additional soft-touch foam layer.

- 1 High rider seat**  
Seat height: 870 mm / 890 mm;  
step length: 1,910 mm / 1,950 mm  
Only available in conjunction with appropriate passenger or rider seat.
- 2 Low rider seat**  
Seat height: 820 mm / 840 mm;  
step length: 1,820 mm / 1,860 mm;  
Only available in conjunction with appropriate passenger or rider seat.
- 3 Comfort rider seat, high**  
Seat height: 850 mm / 870 mm;  
step length: 1,920 mm / 1,940 mm
- 4 Comfort rider seat, low**  
Seat height: 820 mm / 840 mm;  
step length: 1,820 mm / 1,860 mm;
- 5** Only available in conjunction with appropriate passenger or rider seat.

1 High rider seat



2 Low rider seat



3 Comfort rider seat, high



4 Comfort rider seat, low



5 Comfort passenger seat



RALLYE SEAT WITH LUGGAGE PLATE

The narrow Rallye seat with harder padding gives riders maximum freedom of movement. There is still room for the passenger. On the small luggage plate with a GS inscription, objects can be attached close to the vehicle's centre of gravity.

- 1 Rallye seat, high**  
Seat height: 880 mm  
step length: 1,920 mm
- 2 Rallye seat, low**  
Seat height: 860 mm  
step length: 1,880 mm

1 Rallye seat, high, with luggage plate



1 Rallye seat, low, with luggage plate



ADJUSTABLE FOOTBRAKE LEVER AND GEARSHIFT LEVER

The set, consisting of a height-adjustable foot brake lever and a gearshift lever with adjustable kick lever, can be adapted to individual needs. When suitably adjusted, the foot levers can be optimally operated or regulated and allow even better vehicle control especially when riding off-road in a standing position

To be fitted and/or enabled in a specialist workshop, and ideally at your authorised BMW Motorrad Retailer.



ENDURO FOOTRESTS



The Enduro footrest has a wider and longer tread area and therefore offers more support and non-slip footing. This enables better vehicle control when riding off-road in a standing position without restricting the operability of the gearshift lever.

To be fitted and/or enabled in a specialist workshop, and ideally at your authorised BMW Motorrad Retailer.

BLACK RIDER FOOTREST, ADJUSTABLE



The spring-mounted rider footrests with plastic footplate are adjustable in three positions and provide maximum comfort and sure-footedness on and off-road. This means additional stability and even better control of the motorcycle when riding in a standing position, especially off-road.

To be fitted and/or enabled in a specialist workshop, and ideally at your authorised BMW Motorrad Retailer.

PRO GEAR-SHIFT ASSIST



The shift assistant Pro allows shifting up and down in almost all load ranges and engine speed ranges without actuating the clutch or throttle. The assistant thus ensures noticeably reduced shifting times, a relief of the clutch hand and thus greater comfort and dynamics.



**BLACK ADJUSTABLE GEARSHIFT LEVER**

The black anodised gearshift lever can be adapted to the rider's shoe size and provides greater operating comfort when riding in a standing position. The kick lever can be adjusted using a screw so that the distance between the kick lever and the footrest can be customized. This means that even riders with large feet can enjoy riding.



**PRO RIDING MODES RETROFIT SET (NOT SHOWN)**

The Pro riding modes can be retrofitted using an enabling code. Riders without Pro riding modes therefore do not have to do without the modern safety features. Retrofitting is possible with the Pro, Pro with DTC or Pro with ABS Pro riding modes.

To be fitted and/or enabled in a specialist workshop, and ideally at your authorised BMW Motorrad Retailer.

**HEATED GRIPS AND SWITCHES (NOT SHOWN)**

Comfort meets safety. The practical heated grips keep hands pleasantly warm even on cold days and also more responsive. The grip heating controlled by the on-board computer continuously detects the outside temperature via sensors and adjusts the heat output.

To be fitted and/or enabled in a specialist workshop, and ideally at your authorised BMW Motorrad Retailer.

**CRUISE CONTROL RETROFIT SET (NOT SHOWN)**

The electronic cruise control can be activated from 30km/h and keeps the driving speed constant. This makes it possible to enjoy longer motorway stretches in a relaxed style. The function is deactivated on braking, and the selected speed is automatically adopted after activating the Resume button.

To be fitted and/or enabled in a specialist workshop, and ideally at your authorised BMW Motorrad Retailer.



# NAVIGATION & COMMUNICATION

**BMW MOTORRAD NAVIGATOR VI**

With the multifunctional Navigator VI, route planning becomes child's play. The system with 16 GB flash memory and a five-inch touch screen always shows the right way. Thanks to the circular polarisation filter (CPOL), the waterproof display is easy to read even in direct sunlight. The high-resolution screen in a casing similar to a smartphone provides all the essential information and ensures that you can see the big picture required in every situation. Numerous additional functions make planning and touring an exciting experience. Plan your routes can be created according to your personal preferences and enjoy driving on winding and quiet side roads. In unknown terrain, the "round trip" option is a good choice as it reliably guides the rider at the end of the tour back to the starting point. The Bluetooth connection to the BMW Motorrad communication system and the optional Smartphone Link app enable multimedia on the go: navigation announcements, telephone calls and music streaming as well as the retrieval of weather forecasts or traffic jam information are no problem. Navigation preparation adds further functions such as "My Motorcycle", and the multi-controller on the handlebars offers an alternative control option. Choose the pre-installed map data, and you will always be up to date thanks to lifelong, free map updates.

With the help of the preparation for navigation device retrofit, motorcycles without navigation preparation can be retrofitted accordingly. Navigation preparation with a bracket and Mount Cradle for the instrument cluster integrates the BMW Navigator neatly into the cockpit and thus into the rider's direct field of vision.

Note the differences in national-market versions. Only available in conjunction with OE navigation preparation. Also available as optional equipment, option code 272

**1 BMW Motorrad Navigator VI**



**2 Navigation preparation retrofit set**





# SAFETY

## HAND PROTECTORS

The hand protector, made of impact-resistant and UV-resistant plastic, also protects the operating elements against branches and stone chips while riding off-road, and is aerodynamically tailored to the vehicle. On the road, the wind and weather protection offered by the protectors is also impressive: hands and fingers stay longer dry and warm even at low temperatures.

### 1 "Style" hand protector, Light white



### 2 Hand protector



## CYLINDER HEAD COVER GUARD

The stainless steel cylinder-head cover guard provides excellent protection for the cylinder head cover, preventing scratches and damage caused by flying stones. It has been perfectly matched to the motorcycle, is equipped with a large rubber bumper and optimally emphasises the design and contours of the opposed-twin engine.



## ENGINE PROTECTION BAR

The robust engine protection bar, made of polished stainless steel, reliably protects the cylinder area against damage without restricting the rider's freedom to lean the machine. The robust tube construction will even take hard knocks and prevent major fall damage off-road and on asphalt.



## ENDURO ALUMINIUM ENGINE GUARD

The robust Enduro aluminium engine guard (also available in black) effectively protects the lower part of the engine against stone chips and damage. The aluminium engine guard, specially designed for off-road use, is two millimetres thick and significantly wider and longer than the standard engine guard. The special shape also emphasises the motorcycle's off-road look.



### Engine guard, black (not shown)

To be fitted and/or enabled in a specialist workshop, and ideally at your authorised BMW Motorrad Retailer.

## LED ADDITIONAL HEADLIGHTS

The powerful LED additional headlights extend the illumination to ensure the required vision in poor visibility conditions. Thus they perfectly complement the main headlight. LED technology ensures virtually wear-free operation.

To be fitted and/or enabled in a specialist workshop, and ideally at your authorised BMW Motorrad Retailer. The additional headlights are approved for use as fog lights, and may only be used in poor weather conditions. Country-specific road traffic regulations apply.



## SAFETY SCREW FOR OIL FILLER CAP

The safety screw for the oil filler neck is locked using a special Allen® key, preventing theft of the cover. At the same time, unauthorised access and contamination of the oil by foreign substances is prevented. The high-quality aluminium lock has a BMW Boxer inscription.

### Safety screw plug for oil filler neck, black (not shown)



## SPLASH AND FLYING STONE PROTECTION ACCESSORY SET

The accessory set comprises a radiator protector and protective covers for the frame. The robust protective grilles made of impact-resistant plastic protect the radiator from damage caused by stone chips or bushes, especially off-road, while the protective covers protect the rear frame area from damage and provides splash protection when riding through rain or mud.



## RADIATOR COWL

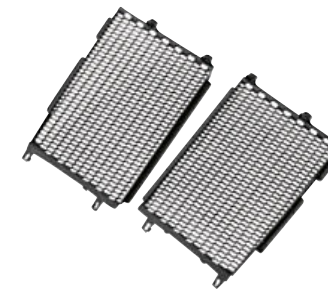

An absolute must-have for all off-road riders: the protective grille made of shatter-proof plastic effectively protects the radiator against damage from stone chips or bushes when riding off-road. This useful extra feature for the left side is very easy to install and also highlights the motorcycle's robust Enduro look.

## HEADLIGHT GUARD



The headlight guard protects the main headlight against stone chip damage when riding on terrain other than public roads. The guard is intended exclusively for off-road use and can be quickly and easily screwed on or unscrewed.

To be fitted and/or enabled in a specialist workshop, and ideally at your authorised BMW Motorrad Retailer.

## FRAME PROTECTOR



The frame protector made of black plastic protects the frame from scratches and prevents chafe marks caused by motorcycle boots in hard off-road use.



---

**PROTECTIVE GLASS FOR  
6.5-INCH TFT DISPLAY**

The protective glass reliably protects the 6.5-inch TFT display from dirt, flying stones and damage. The hardened glass has an anti-glare and anti-reflective surface, so that the TFT display can be read easily. With BMW Motorrad inscription.



---

**RETROFIT SET  
FOR ANTI-THEFT ALARM  
(NOT SHOWN)**

NEW

Strong protection from theft: If the motorcycle is moved or struck violently, the anti-theft alarm system responds with a clearly audible signal and a flashing warning light. The acoustic and optical warning will draw the attention of passers-by quickly. The alarm system is activated automatically when the ignition is switched off.

Note the differences in national-market versions.  
To be fitted and/or enabled in a specialist workshop,  
and ideally at your authorised BMW Motorrad Retailer.

---

**DAYTIME RUNNING LIGHT  
RETROFIT SET  
(NOT SHOWN)**

---

**TYRE PRESSURE CONTROL  
RETROFIT SET  
(NOT SHOWN)**

Tyre Pressure Control (TPC) with all functions can be retrofitted by installing the control unit. TPC provides reliable information about the current tyre pressure and warns the rider about pressure loss at an early stage. The corresponding notifications and instructions are provided by the on-board computer in the cockpit.

To be fitted and/or enabled in a specialist workshop,  
and ideally at your authorised BMW Motorrad Retailer.

---

**ABS PRO RETROFIT SET  
(NOT SHOWN)**

To be fitted and/or enabled in a specialist workshop,  
and ideally at your authorised BMW Motorrad Retailer.





# ACCESSORIES FOR BMW R 1250 GS ADVENTURE



## HP PARTS

### HP SPORTS SILENCER



A top-class feature for top quality sound. The sleek, high-quality titanium slip-on silencer with carbon end-cap delivers a powerful rumble. In addition, the sport silencer developed with Akrapovič is weight-optimised compared to the standard silencer.

No approval for USA. Please note the specifications for different countries.

### HP HAND LEVER, ADJUSTABLE



The CNC-milled HP hand levers made of anodised aluminium combine functionality and aesthetics. The grip width can be adjusted in five steps (brake lever) or three steps (clutch lever) using a setting screw and thus adapted to individual requirements. The look with HP logo also emphasises the bike's sportiness.

### HP COVERS FOR EXPANSION TANKS



The HP cover for expansion tanks made of anodised aluminium also adds to the bike's sporty character. The high-quality milled cover with HP branding emphasises the high-performance claim and also provides for an attractive customisation of the bike.

### HP MIRRORS



The high-quality HP mirrors are made of milled aluminium and emphasise the sporty character of the bike. The low-vibration construction and aerodynamic shape ensure excellent visibility. The attractive design with BMW Motorrad inscription also creates a strong individualisation effect.

### HP ENGINE HOUSING COVER, FRONT



The HP engine housing cover made of anodised aluminium also adds to the bike's sporty character. The high-quality milled cover and HP branding emphasise the high-performance standard and also guarantee an attractive customisation of the bike.

### HP FOOT LEVER AND RIDER FOOTRESTS, ADJUSTABLE



The HP rider footrests with plastic footplates are adjustable in three positions and provide maximum comfort and surefootedness on and off-road. The high-quality milled parts made of anodised aluminium provide more control especially when riding in a standing position. The exclusive look with HP logo also emphasises the bike's performance-based character.

The milled HP foot levers made of anodised aluminium are adjustable and come in sporty HP blue / silver / black. With the right set up, the foot levers can also be operated better and more sensitively when riding while standing up during off-road use. The exclusive look with HP logo also emphasises the bike's performance-based character.

### HP CYLINDER HEAD COVERS



The HP cylinder head covers made of anodised aluminium give the opposed-twin engine an attractive appearance. The high-quality milled covers and HP branding highlight the motorcycle's sporty character. The HP oil filler plug perfectly matches the cylinder head covers.



# STORAGE

## ALUMINIUM CASES

The perfect solution for touring fans who place the highest demands on themselves and their equipment: the aluminium case for mounting on the left-hand side offers 44 litres of storage space. The aluminium case for mounting on the right-hand side offers 36 litres of storage space. This robust piece of transport equipment is dust- and waterproof. Many practical details impress even under extreme conditions.

Not available in conjunction with LED indicators at the rear with short base TNR 8 522 499; install LED indicators with long base TNR 8 522 500 if necessary. For information on speed and load restrictions, please refer to the instruction booklet.

1 Aluminium case



2 Aluminium case, black



## ALUMINIUM TOPCASE

The waterproof topcase has a capacity of 32 litres and lashing eyes for securing additional luggage. And with the optional backrest pad added, it provides increased comfort for the passenger.

For information on speed and load limitations, please refer to the instruction booklet.

1 Aluminium topcase, 32l



2 Aluminium topcase, black, 32l



3 Aluminium backrest pad for aluminium topcase



## CARRY HANDLE FOR ALUMINIUM CASE/TOPCASE

Convenient and functional: The practical carry handles for aluminium cases and topcases make it easy to transport the luggage to and from the bike. If the cases are mounted, additional luggage can also be attached to the handles.



## MOUNTING KIT FOR CASE RACK FOR ALUMINIUM CASES

The aluminium side cases and the "Atacama" side bags can be easily and securely attached to the sturdy case rack made of polished or black powder-coated stainless steel. In addition to a typical Enduro appearance, the case rack also serves as a traction point for off-road use.

### 1 & 2

Not available in conjunction with Rallye seat with luggage plate. Only available in conjunction with part number 77 30 8 546 226 (cover kit for holes for grab handles) if the standard passenger grab handles have been removed.

### 2 & 3

When used with aluminium cases, the black coating rubs off at the contact points.

The Atacama luggage roll or other pieces of luggage can be attached to the sturdy topcase carrier made of powder-coated stainless steel.

1 Case holders for aluminium cases



2 Black case holders for aluminium cases



3 Black topcase carrier for aluminium topcase





**LINER FOR ALUMINIUM CASES AND ALUMINIUM TOPCASES**

The waterproof liner for the aluminium case gets the luggage organised and facilitates loading and unloading. The carry handle and shoulder strap make the bag easy to access and transport. Alternatively, the sturdy bag can also be attached to the outside of the case, creating additional storage space.



**LUGGAGE COMPARTMENT SEPARATING NET FOR ALUMINIUM CASES**

The luggage net for aluminium cases and topcases creates more order and makes it easier to access frequently used items. The highly flexible net is attached to the inside of the lid and ensures that luggage such as raincoats, folding backpacks, toiletry bags and sneakers are always at hand when the case is opened.



**ATACAMA LUGGAGE SYSTEM**

The Atacama side bags convince with clever details and a combined storage volume of 60 litres. In addition to the waterproof liners, various storage compartments provide additional space. Quick-release fasteners for easy mounting on the motorcycle and sturdy carry handles ensure a secure hold and extremely practical handling.

The extremely durable Atacama luggage roll sports many clever details and an enormous storage volume of 40 litres.

The Atacama side bags and roll bag and other pieces of luggage or helmets can be secured to the motorcycle using the lockable tension straps with steel core.

**1**  
Only available in conjunction with case rack for aluminium cases. For information on speed and load restrictions, please refer to the instruction booklet.

**3**  
For information on speed and load limitations, please refer to the instruction booklet. Rubs off at the contact points.

**1 Atacama side bags**



**2 Tensioning straps for Atacama side bags, lockable**



**3 Atacama luggage roll, 40l**



**4 Tensioning strap for Atacama roll bag, lockable**



**LUGGAGE PLATE FOR PASSENGER SEAT**

The luggage plate made of black painted plastic replaces the passenger seat and offers the ideal basis for safely transporting luggage. In combination with the variable cases, the result is a wide, flat packing surface on which even larger objects can be secured close to the vehicle's centre of gravity.

Not available in conjunction with Rallye seat with luggage plate. Only available in conjunction with part number 77 30 8 546 226 (cover kit for holes for grab handles) if the standard passenger grab handles have been removed.



**TRIMS FOR GRAB HANDLE HOLES**

The trims for grab handle holes cover the open holes when the passenger grab handles are removed and thus protect against dirt. They also create a typical Enduro appearance.



**TANK BAG, 12-16 L**

The waterproof liner for the aluminium case gets the luggage organised and facilitates loading and unloading. The carry handle and shoulder strap make the bag easy to access and transport. Alternatively, the sturdy bag can also be attached to the outside of the case, creating additional storage space.

For information on speed and load restrictions, please refer to the instruction booklet.

**BAG FOR FRAME**

The lined pocket made of PVC-coated polyester fabric is attached to the frame below the rider's seat and does not restrict freedom of movement. Now smaller items are also always on board while on the road. The water-repellent zip fastener with non-slip zipper allows quick access.





**BAG FOR PASSENGER SEAT, 14-18 L**

With a waterproof main compartment which can be expanded from 14 to 18 litres, this durable bag for the passenger seat offers enough storage space for the daily ride to work or for day trips. The three-sided zip fastener allows quick access, while the functional carrying handle facilitates transport.

For information on speed and load restrictions, please refer to the instruction booklet.

1 Bag for passenger seat, 14-18 l



2 Bag for passenger seat, 14-18 l



**POCKET FOR WIND DEFLECTOR**

The high-quality pockets made of PVC-coated polyester fabric are attached behind the trim panel and thus allow quick access to the contents. The lined storage space is particularly suitable for smaller items such as smartphones up to 5 inches, which are safe and protected there.



DESIGN

**OPTION 719 CLASSIC HAND LEVERS, ADJUSTABLE**



The Classic hand levers of the exclusive Option 719 are milled from an anodised aluminium alloy. The grip width can be adjusted in five steps (brake lever) or three steps (clutch lever) using a setting screw and thus adapted to individual requirements. The high-quality Billet Pack parts with Option 719 branding add value to the bike.

To be fitted and/or enabled in a specialist workshop, and ideally at your authorised BMW Motorrad Retailer.

**OPTION 719 CLASSIC COVERS FOR EXPANSION TANKS**



The Option 719 Classic covers for expansion tanks set an elegant, design highlight with their silver-coloured appearance. The milled cover made of anodised aluminium bears the inscription "Option 719". Together with the other special parts of Option 719 an exclusive customisation effect is created.

**OPTION 719 CLASSIC ENGINE HOUSING COVER, FRONT**



The Option 719 Classic engine housing cover sets an elegant, design highlight with its silver-coloured look. The high-quality milled cover made of anodised aluminium bears the "Option 719" inscription. Together with the other special parts of Option 719 an exclusive customisation effect is created.

To be fitted and/or enabled in a specialist workshop, and ideally at your authorised BMW Motorrad Retailer.

**OPTION 719 ADJUSTABLE CLASSIC RIDER FOOTRESTS AND FOOT LEVERS**



The Classic aluminium rider footrests with plastic footplate are adjustable in three positions and provide maximum comfort and surefootedness on and off-road. The high-quality milled parts of the exclusive Option 719 provide additional stability and even better control of the motorcycle when riding in a standing position, especially off-road.

The exclusive Option 719 Classic foot levers are milled from anodised aluminium and are individually adjustable. With the right set up, the foot levers can also be operated better and more sensitively when riding while standing up during off-road use. The high-quality Billet Pack parts with Option 719 branding add value to the bike.

To be fitted and/or enabled in a specialist workshop, and ideally at your authorised BMW Motorrad Retailer.

**OPTION 719 CLASSIC CYLINDER HEAD COVERS**



The Classic cylinder head covers of the exclusive Option 719 add design highlights with their silver-coloured appearance. The high-quality milled covers made of anodised aluminium bring the opposed-twin engine into the spotlight. The exclusive special parts bear the inscription "Option 719" and emphasise the high-quality character of the bike.

To be fitted and/or enabled in a specialist workshop,



OPTION 719 CLASSIC OIL FILLER PLUG



The safety screw for the oil filler neck is locked using a special Allen® key, preventing theft of the cover. At the same time, unauthorised access and contamination of the oil by foreign substances is prevented. The high-quality aluminium lock has a BMW Boxer inscription.

OPTION 719 SILVER MIRRORS



The Option 719 silver-coloured mirrors are made of milled aluminium and highlight the high-quality character of the bike. The low-vibration construction and aerodynamic shape ensure excellent visibility. The attractive design also creates a strong individualisation effect.

CHROME-PLATED EXHAUST MANIFOLD



The chrome-plated exhaust manifold further enhances the motorcycle's appearance. This elegant manifold can be combined with the standard silencer or the HP sport silencer.

CHROME-PLATED REAR SILENCER



The high-quality chrome-plated rear silencer perfectly harmonises with other motorcycle chrome applications.

To be fitted and/or enabled in a specialist workshop, and ideally at your authorised BMW Motorrad Retailer.

BLACK REAR FOOTRESTS RACK



To be fitted and/or enabled in a specialist workshop, and ideally at your authorised BMW Motorrad Retailer.

REAR-WHEEL COVER



The milled aluminium rear-wheel cover emphasises the dynamic design of the bike. The black anodised covers with BMW Motorrad inscription and a diameter of 62 mm enhance the motorcycle visually and technically.

LED TURN INDICATORS

A shining example: the elegant LED indicators with white indicator glass match the motorcycle's look and also enhance it. Moreover, they impress with their sleek design and modern lighting technology. For example, they respond faster than classic bulbs and are virtually wear-free.

Note the differences in national-market versions.  
To be fitted and/or enabled in a specialist workshop, and ideally at your authorised BMW Motorrad Retailer.



# ERGONOMICS & COMFORT

WIND DEFLECTOR AND WINDSCREENS

The high-quality windscreen with its dark tint impressively underlines the motorcycle's sporty look. It has the same dimensions as the standard windscreen and, thanks to its scratch-resistant coating on both sides, ensures great, lasting visibility in all conditions.

The Rallye windscreen was specially developed for off-road use. It is small enough to give the rider a clear view of the terrain and yet offers protection and freedom of movement when riding in a standing position. The Enduro-specific appearance underlines the machine's off-road potential.

The tinted wind deflectors with their stylish look give the bike a particularly casual touch and provide greater riding comfort on every journey.

**1 & 4**

Note the differences in national-market versions. To be fitted and/or enabled in a specialist workshop, and ideally at your authorised BMW Motorrad Retailer.

1 High windscreen, tinted



2 Rallye screen



3 Wind deflector, tinted



4 Windscreen, tinted



5 Rallye windscreen, tinted





---

**EXCLUSIVE RIDER AND PASSENGER SEAT**

Thanks to the smooth but very dimensionally stable soft-touch insert, the Exclusive rider's seat offers a noticeable improvement in seating comfort even on longer journeys. The high-quality impression invite the riders to get on the bike as soon as they see it.

The Exclusive rider's seat with the soft-touch insert is 20mm higher and offers particularly tall riders noticeably better seating comfort.

The lower Exclusive rider's seat makes getting on and off the bike easier and offers a noticeable improvement in seating comfort thanks to the soft-touch insert.

Thanks to the smooth but very dimensionally stable soft-touch insert, the Exclusive passenger seat offers a noticeable improvement in seating comfort and invites the passenger to get on. The seat is also available in a narrow design.

Only available in conjunction with appropriate passenger or rider seat.

---

**1 Exclusive rider seat**



---

**2 Exclusive rider seat, high**



---

**3 Exclusive rider seat, low**



---

**4 Exclusive passenger seat**



---

**RIDER SEAT**

The rider seat in black is 20mm higher and offers particularly tall riders noticeably better seating comfort.

20mm lower than the standard version, this black rider's seat makes climbing on and off easier and keeps the ground within easy reach.

Only available in conjunction with appropriate passenger or rider seat.

---

**1 High rider seat**



---

**2 Low rider seat**



---

**RALLYE SEAT WITH LUGGAGE PLATE**

The narrow and harder padded Rallye seat is tailor-made for off-road use and offers the rider maximum freedom of movement in off-road conditions. There is still room for the passenger. On the small luggage plate with a GS inscription, objects can be attached close to the vehicle's centre of gravity.





**BLACK RIDER FOOTREST, ADJUSTABLE**

The spring-mounted rider footrests with plastic footplate are adjustable in three positions and provide maximum comfort and sure-footedness on and off-road. This means additional stability and even better control of the motorcycle when riding in a standing position, especially off-road.



**ENDURO FOOTRESTS**

The Enduro footrest has a wider and longer tread area and therefore offers more support and non-slip footing. This enables better vehicle control when riding off-road in a standing position without restricting the operability of the gearshift lever.

To be fitted and/or enabled in a specialist workshop, and ideally at your authorised BMW Motorrad Retailer.



**PRO RIDING MODES RETROFIT SET (NOT SHOWN)**

The Pro riding modes can be retrofitted using an enabling code. Riders of older motorcycles therefore do not have to do without modern safety features. Depending on the year of manufacture, retrofitting is possible with the Pro, Pro with DTC or Pro with ABS Pro, DTC and HSC modes.

To be fitted and/or enabled in a specialist workshop, and ideally at your authorised BMW Motorrad Retailer.

**HILL START CONTROL RETROFIT SET (NOT SHOWN)**

The Hill Start Control (HSC) drive-off assistant can be retrofitted using an enabling code. Therefore, the driver does not have to do without the convenient assistance system. HSC makes stopping and starting on slopes easier and offers valuable support, especially when the bike has a full load.

To be fitted and/or enabled in a specialist workshop, and ideally at your authorised BMW Motorrad Retailer.

**ADJUSTABLE FOOTBRAKE LEVER AND GEARSHIFT LEVER, BLACK**

The set, consisting of Enduro footrests, a height-adjustable foot brake lever and a gearshift lever with adjustable kick lever, can be adapted to individual needs. When suitably adjusted, the foot levers can be optimally operated or regulated and allow even better vehicle control especially when riding off-road in a standing position.

Provides improved control when standing. With adjustable toe piece.

To be fitted and/or enabled in a specialist workshop, and ideally at your authorised BMW Motorrad Retailer.

**1 Adjustable footbrake lever**



**2 Adjustable gearshift lever, black**



**PRO GEAR-SHIFT ASSIST**

The shift assistant Pro allows shifting up and down in almost all load ranges and engine speed ranges without actuating the clutch or throttle. The assistant thus ensures noticeably reduced shifting times, a relief of the clutch hand and thus greater comfort and dynamics.



**HEATED GRIPS AND SWITCHES (NOT SHOWN)**

Comfort meets safety. The practical heated grips keep hands pleasantly warm even on cold days and also more responsive. The grip heating controlled by the on-board computer continuously detects the outside temperature via sensors and adjusts the heat output.

To be fitted and/or enabled in a specialist workshop, and ideally at your authorised BMW Motorrad Retailer.





# NAVIGATION & COMMUNICATION

## BMW MOTORRAD NAVIGATOR VI

With the multifunctional Navigator VI, route planning becomes child's play. The system with 16GB flash memory and a five-inch touch screen always shows the right way. Thanks to the circular polarisation filter (CPOL), the waterproof display is easy to read even in direct sunlight. The high-resolution screen in a casing similar to a smartphone provides all the essential information and ensures that you can see the big picture required in every situation. Numerous additional functions make planning and touring an exciting experience. Plan your routes can be created according to your personal preferences and enjoy driving on winding and quiet side roads. In unknown terrain, the "round trip" option is a good choice as it reliably guides the rider at the end of the tour back to the starting point. The Bluetooth connection to the BMW Motorrad communication system and the optional Smartphone Link app enable multimedia on the go: navigation announcements, telephone calls and music streaming as well as the retrieval of weather forecasts or traffic jam information are no problem. Navigation preparation adds further functions such as "My Motorcycle", and the multi-controller on the handlebars offers an alternative control option. Choose the pre-installed map data, and you will always be up to date thanks to lifelong, free map updates.

With the help of the preparation for navigation device retrofit, motorcycles without navigation preparation can be retrofitted accordingly. Navigation preparation with a bracket and Mount Cradle for the instrument cluster integrates the BMW Navigator neatly into the cockpit and thus into the rider's direct field of vision.

Note the differences in national-market versions. Only available in conjunction with OE navigation preparation. Also available as optional equipment, option code 272

### 1 BMW Motorrad Navigator VI



### 2 Navigation preparation retrofit set



# SAFETY

## "STYLE" HAND PROTECTOR, LIGHT WHITE

The "Light white" "Style" hand protector, made of shatter-proof and UV-resistant plastic, also protects the operating elements from branches and stone chips while riding off-road. On the road, the wind and weather protection offered by the protectors is also impressive: hands and fingers stay longer dry and warm even at low temperatures.



## CYLINDER HEAD COVER GUARD

The stainless steel cylinder-head cover guard provides excellent protection for the cylinder head cover, preventing scratches and damage caused by flying stones. It has been perfectly matched to the vehicle, is equipped with a large rubber bumper and optimally emphasises the design and contours of the opposed-twin engine.



## ENDURO ALUMINIUM ENGINE GUARD

The robust Enduro aluminium engine guard effectively protects the lower part of the engine against stone chips and damage. The aluminium engine guard, specially designed for off-road use, is two millimetres thick and significantly wider and longer than the standard engine guard. The special shape also emphasises the motorcycle's off-road look.

Engine guard, black  
(not shown)

To be fitted and/or enabled in a specialist workshop, and ideally at your authorised BMW Motorrad Retailer.



## RADIATOR COWL

An absolute must-have for all off-road riders: the protective grille made of shatter-proof plastic effectively protects the radiator against damage from stone chips or bushes when riding off-road. This useful extra feature for the left side is very easy to install and also highlights the motorcycle's robust Enduro look.

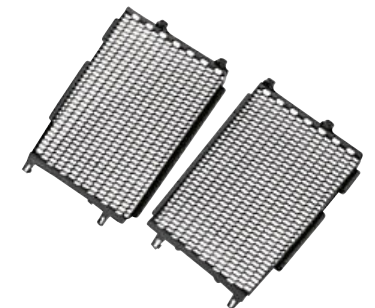



**LED ADDITIONAL HEADLIGHTS**

The powerful LED additional headlights extend the illumination to ensure the required vision in poor visibility conditions. Thus they perfectly complement the main headlight. LED technology ensures virtually wear-free operation.

To be fitted and/or enabled in a specialist workshop, and ideally at your authorised BMW Motorrad Retailer. The additional headlights are approved for use as fog lights, and may only be used in poor weather conditions. Country-specific road traffic regulations apply.



**SAFETY SCREW FOR OIL FILLER CAP**

The safety screw for the oil filler neck is locked using a special Allen® key, preventing theft of the cover. At the same time, unauthorised access and contamination of the oil by foreign substances is prevented. The high-quality aluminium lock has a BMW Boxer inscription.

**Safety screw plug for oil filler neck, black (not shown)**



**HEADLIGHT GUARD**



The headlight guard protects the main headlight against stone chip damage when riding on terrain other than public roads. The guard is intended exclusively for off-road use and can be quickly and easily screwed on or unscrewed.

To be fitted and/or enabled in a specialist workshop, and ideally at your authorised BMW Motorrad Retailer.

**FRAME PROTECTOR**



The frame protector made of black plastic protects the frame from scratches and prevents chafe marks caused by motorcycle boots in hard off-road use.

**PROTECTIVE GLASS FOR 6.5-INCH TFT DISPLAY**



The protective glass reliably protects the 6.5-inch TFT display from dirt, flying stones and damage. The hardened glass has an anti-glare and anti-reflective surface, so that the TFT display can be read easily. With BMW Motorrad inscription.

**SPLASH AND FLYING STONE PROTECTION ACCESSORY SET**



The accessory set comprises a radiator protector and protective covers for the frame. The robust protective grilles made of impact-resistant plastic protect the radiator from damage caused by stone chips or bushes, especially off-road, while the protective covers protect the rear frame area from damage and provides splash protection when riding through rain or mud.

**ANTI-THEFT ALARM RETROFIT SET (NOT SHOWN)**

**NEW**

Strong protection from theft: If the motorcycle is moved or struck violently, the anti-theft alarm system responds with a clearly audible signal and a flashing warning light. The acoustic and optical warning will draw the attention of passers-by quickly. The alarm system is activated automatically when the ignition is switched off.

Note the differences in national-market versions. To be fitted and/or enabled in a specialist workshop, and ideally at your authorised BMW Motorrad Retailer.

**TYRE PRESSURE CONTROL RETROFIT SET (NOT SHOWN)**

Tyre Pressure Control (TPC) with all functions can be retrofitted by installing the control unit. TPC provides reliable information about the current tyre pressure and warns the rider about pressure loss at an early stage. The corresponding notifications and instructions are provided by the on-board computer in the cockpit.

To be fitted and/or enabled in a specialist workshop, and ideally at your authorised BMW Motorrad Retailer.

**DAYTIME RUNNING LIGHT RETROFIT SET (NOT SHOWN)**

**ABS PRO RETROFIT SET (NOT SHOWN)**

To be fitted and/or enabled in a specialist workshop, and ideally at your authorised BMW Motorrad Retailer.



## MAINTENANCE & TECHNOLOGY

### ADDITIONAL POWER SOCKET

Electronic devices can be connected to the vehicle electrical system via the 12V power socket. One example of this is the BMW USB charger, which can be used to charge and operate mobile phones and MP3 players with an appropriate interface while riding.

To be fitted and/or enabled in a specialist workshop, and ideally at your authorised BMW Motorrad Retailer.





# ACCESSORIES FOR ALL MODELS

TYRES	306	MAINTENANCE & TECHNOLOGY	312
STORAGE	308	ADVANTEC ORIGINAL BMW ENGINE OIL	314
NAVIGATION & COMMUNICATION	310	ORIGINAL BMW CARE PRODUCTS	315
SAFETY	311		





## YOUR TYRES: THE PERFECT PAIR FOR MAINTAINING WHEEL GRIP DURING CORNERING.

They are your direct contact to the road. The decisive link against the centrifugal forces in the curve: your tyres. There is hardly anything that influences your motorcycle's handling more. There is a lot of discussion about the right tyres because anyone who has first-hand experience knows that two identical motorcycles drive very differently if they have different tyres.

Your authorised BMW Motorrad Retailer offers a selection of suitable tyres from well-known manufacturers for your bike. They are all chosen based on very extensive tyre tests. As preferences often vary depending on riding style and ability, many different types of tyres are tested and they are only given BMW Motorrad's official seal of approval after thorough testing. This is how we make sure that your tyres, in combination with your bike, perform optimally depending on the situation – when accelerating, cornering and braking.

So it makes sense to both have your BMW serviced at our trained authorised BMW Motorrad dealer and to have it fitted with a fresh set of tyres or tubes when necessary. With this "One-Stop" you not only save time, you can also make sure that you're driving using the perfect tyres. Your authorised BMW Motorrad dealer knows exactly which tyre is right for your riding style and your bike. Guarantees many thousands of kilometres of riding fun.

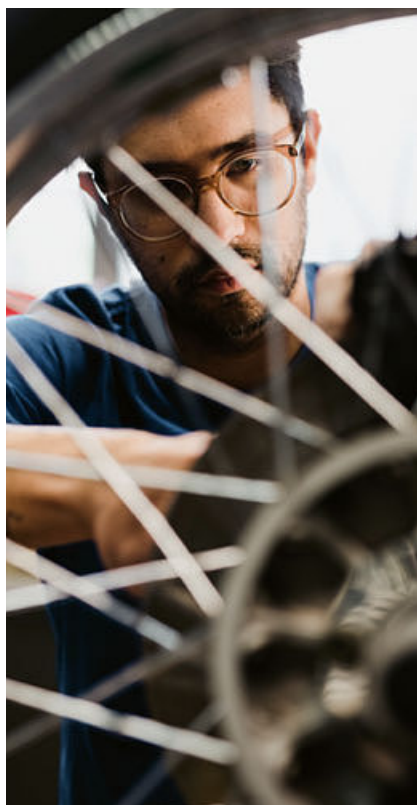
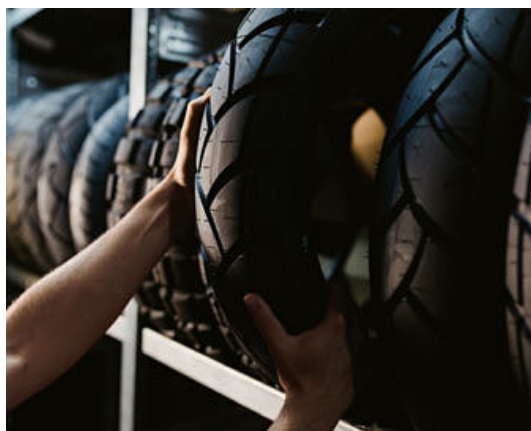

## YOUR BIKE. YOUR TYRES. THE RIGHT COMBINATION DOES THE TRICK.



### COMPACT FOOT PUMP



### ON THE ROAD WITH THE BEST TYRES.

Your authorised BMW Motorrad dealer is not only a specialist for your BMW, but also for the right tyres. So they know exactly which Enduro, Touring or Sport tyres are the best for you and your riding style. The right combination of tread, tyre contour, rubber compound, vehicle geometry and other factors make the perfect compound for you and your BMW.

There are a number of helpful tools around the topic of tyres, which we present to you in this catalogue. For example, tyre puncture sets, mini foot pumps and multifunctional tools. This way you are always safe on gravel, sand and asphalt.





# STORAGE

LUGGAGE ROLL, 50 L



This waterproof luggage roll with large opening can be used universally and offers a volume of 50 litres. The zippered liner and the small outer mesh pocket provide space for smaller items. A detachable shoulder strap and padded carry handles make transport to and from the bike easy.

ATACAMA LUGGAGE ROLL, 40 L



The Atacama luggage roll made of a robust mix of materials convinces with clever details and a storage volume of 40 litres. In addition to the waterproof liner, various storage compartments provide additional space. The versatile fastening concept, three carry handles and backpack function ensure a secure hold and extremely practical handling.

The Atacama roll bag and other pieces of luggage or helmets can be secured to the motorcycle using the optionally available lockable tension straps with steel core.

PACK BAG SET



The practical pack bag set keeps the BMW Motorrad case organised. It includes five tear-resistant, washable and foldable bags in sizes S, M and L as well as a laundry bag with a gym bag closure. Different colours for zippers and handles make it easier to distinguish. The two large bags have a reinforced base.

SMALL SOFTBAG, 30-35 L



The small softbag with its waterproof main compartment and water-repellent exterior pockets offers a storage volume from 30 to 35 litres. The padded carry handle and a shoulder strap make transport easy. Can be mounted individually to the bike with adjustable straps with snap-fit fasteners.

LARGE SOFTBAG, 50-55 L



The large softbag with its waterproof main compartment and water-repellent exterior pockets offers a storage volume from 50 to 55 litres. The padded carry handle and a shoulder strap make transport easy. Can be mounted individually to the bike with adjustable straps with snap-fit fasteners.

BAG FOR LUGGAGE CARRIER



The bag for the luggage carrier has a waterproof main compartment and, with a volume of 4.5 litres, provides enough storage space for day trips or the daily ride to work. It is a practical addition or alternative to the tank bag. The zip fastener on three sides allows quick access, while the carry handle facilitates transport.

FOLDING BACKPACK



The lightweight folding backpack is a helpful and durable companion when spontaneous storage space is needed on the road. For transport, simply fold it into the integrated zipper pocket. Its compact dimensions mean it can be cleverly stowed under the seat of the motorcycle or taken everywhere for other purposes.

SMARTPHONE POCKET



Smartphones with up to a display size of 5.1 inches can be safely stowed in the waterproof, padded smartphone pocket and stored under the seat. The charging cable is simply rolled up in the roll closure - the smartphone can then also be connected to the charger while riding or used as a navigation device.



# NAVIGATION & COMMUNICATION

## BMW MOTORRAD DUAL USB CHARGER WITH CABLE



With the dual USB charger from BMW Motorrad, two mobile devices can be charged simultaneously while riding. The device recognises the charging technology of all current smartphones and delivers a charging current of max. 2x2 A. The charger is connected to the 12V on-board socket via a 60 cm or 120 cm cable.

Available in 60 and 120 cm length.

## CAR KIT FOR BMW MOTORRAD NAVIGATOR VI



If the motorcycle stays at home, the BMW Navigator (versions V and VI) can also be used in the car in just a few easy steps thanks to the car kit. The car kit can be securely attached to the windscreen with the suction holder and has a built-in loudspeaker.

## BMW ADAPTER CABLE (NOT SHOWN)

The BMW adapter cable can be used to connect an Apple iPhone or iPod to the motorcycle's dual USB charger for charging. Thanks to the adapted cable length of 35 cm and the robust design with solid metal plug, the cable is ideally suited for use on motorcycles.

If the weather conditions get too tough for original charging cables, the BMW micro USB adapter comes to the rescue. The robust adapter cable also enables the rider to safely charge mobile devices – smartphones, MP3 players, tablets or cameras – using the BMW dual USB charger via micro USB while on the road.

## BMW adapter cable for Apple iPhone/iPod & BMW adapter cable for micro USB

K48/52/61: Caution: Only for charging. No multimedia functions.  
All others: Only available in conjunction with the dual USB charger.



# SAFETY

## FIRST-AID KIT, LARGE



The extensive first aid kit, large from BMW Motorrad complies with the German DIN standard for motorcycle first aid kits and should not be missing from any motorcycle. It is packed specially for motorcyclists and contains everything needed in an emergency, from gauze to an emergency blanket and first aid instructions.

## FIRST-AID KIT, SMALL



The compact first aid kit from BMW Motorrad fits into any motorcycle and contains basic equipment for treating minor injuries. In addition to a range of plasters and disposable gloves, the nylon bag also contains skin cleansing wipes, a first aid dressing and an emergency blanket.

## BRAKE DISC LOCK WITH ANTI-THEFT ALARM SYSTEM

Double protection against theft: The brake disc lock with anti-theft alarm is the ideal theft deterrent when you're out with your bike. The lock made of hardened steel provides reliable protection against manipulation and is easy to store thanks to its compact dimensions. The anti-theft alarm detects the smallest movements and violent shocks and responds by emitting an acoustic alarm.



Original BMW Motorrad accessories are available from your authorised BMW Motorrad Retailer.

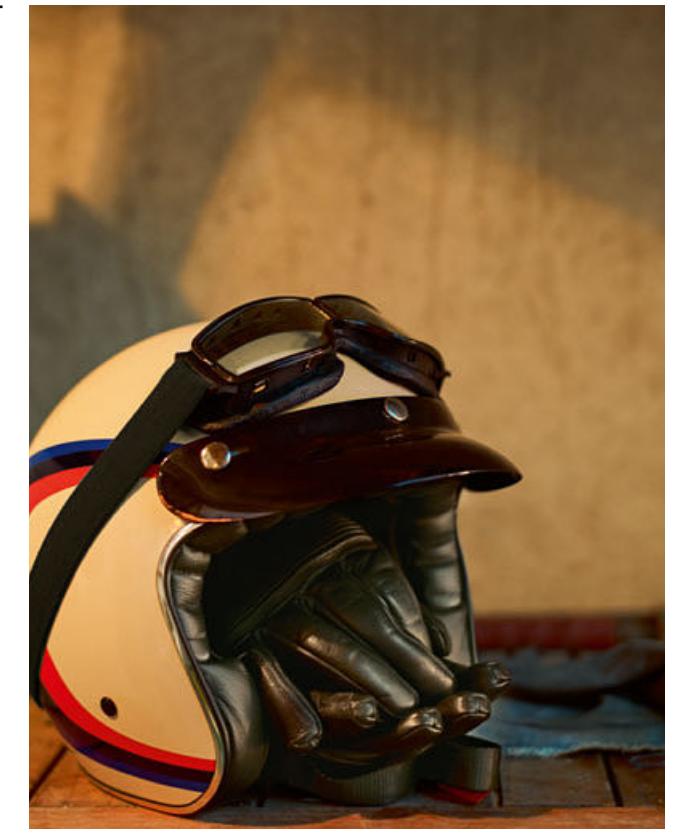



# MAINTENANCE & TECHNOLOGY

## BMW MOTORRAD BATTERY CHARGER PLUS

In addition to charging conventional lead-acid batteries and maintenance-free rechargeable batteries (gel/AGM), the high-quality BMW Motorrad battery charger Plus also allows for fully automatic, microprocessor-controlled charging and maintenance of all Original BMW Motorrad lithium-ion starter batteries with 12V and a capacity of 6 to 60Ah.

Available in 110V, 230V and UK versions. Please note the specifications for different countries



## ON-BOARD TOOL KIT

Simple maintenance and care work can also be carried out on the road using the on-board tool kit. The set is small, lightweight, multifunctional and is stored in a practical tool bag. An adapter with a quick-release fastener and ball lock guarantees fast and flexible handling of the individual tools.



## MULTIFUNCTIONAL TOOL

The BMW Motorrad multifunctional tool has everything under control – exactly 40 useful tools for on the go and at home. From the locking blade, screwdriver and pliers to the reversible ratchet with bit extension and nine screwdriver bits.



## MOTORBIKE CARPET

An exclusive place for the bike: the motorcycle mat not only impresses with its attractive design, it also reliably protects the floor from dirt, oil and petrol stains. A further advantage is the anti-slip and fire-retardant material composition. The practical underlay is generously sized at 250x115 cm.



## COMPACT FOOT PUMP

The mini foot pump is a genuine all-rounder. Fitted with a digital manometer, it's ideal for increasing air pressure in the air damping system, adjusting tyre pressure and even pumping up car and bike tyres, balls and mattresses.



## TYRE PRESSURE TRAVEL SET

The travel set for tyre pressure monitoring includes a small digital measuring device and CO<sub>2</sub> cartridges for filling.



## VEHICLE COVER

The vehicle cover for outdoors reliably protects your bike from rain, dirt and more. The high-quality nylon cover is waterproof and has ventilation openings and a viewing window for the license plate. Drawstrings and two metal eyelets guarantee secure attachment to the motorcycle.



## INDOOR VEHICLE COVER

The highly elastic indoor vehicle cover reliably protects the motorcycle against dust and scratches. The antistatic and breathable material also prevents condensation build-up. Three versions, which vary in shape and design (for covering different model types).

- 1 Without side case
- 2 With side cases

### 1 Indoor vehicle cover



### 2 Indoor vehicle cover, large



### 3 Indoor vehicle cover





WORKSTANDS

Easy to set up, this sturdy workstand holds your BMW securely in place, making maintenance easier to carry out.

1 Auxiliary stand, rear



2 Sport auxiliary stand, rear



3 Sport auxiliary stand, front



ORIGINAL BMW ENGINE OIL ADVANTEC

Designed exclusively for and tested by BMW, with high-performance BMW Motorrad bikes in mind, ADVANTEC Pro, ADVANTEC Ultimate and ADVANTEC Classic set the benchmark for lubricants.

**Original BMW Engine Oil ADVANTEC Pro 15W-50, 1l & Original BMW Engine Oil ADVANTEC Ultimate 5W-40, 1l (not shown)**

Please note the specifications for different countries.

1 Original BMW Engine Oil ADVANTEC Pro 15W-50, 500ml



2 Original BMW Engine Oil ADVANTEC Classic 20W-50, 1l



3 Original BMW Engine Oil ADVANTEC Ultimate 5W-40, 500ml



LED TORCH

Small, robust, reliable - and extremely bright: the rechargeable LED torch with a light output of over 80 lumens impresses thanks to its enormous headlight range and an above-average service life of up to 3000 charging cycles. The battery can be easily charged via the 12V power socket on the motorcycle.



GENUINE BMW CARE PRODUCTS



Availability may vary depending on the country. Not every product is available in every country due to different import laws for chemical products.

FROM LEFT TO RIGHT

**Motorcycle cleaner, 500 ml**  
Get off the bike after a ride – the same goes for dirt. The specially developed motorcycle cleaning fluid removes even the heaviest dirt.

**Wheel rim cleaner, 500 ml**  
The BMW Motorrad wheel rim cleaner effectively removes impurities like brake dust and dirt picked up from the street.

**Engine shine spray, 300 ml**  
The engine shine spray from BMW Motorrad is a heat-resistant care product especially for engine and exhaust parts painted black. It serves to prevent discolouration and to refresh faded colours as well as already damaged black paintwork.

**Chain cleaner, 300 ml**  
The BMW Motorrad chain cleaner also removes abrasive substances such as old chain lubricant, sand and street dirt from the chain sprocket.

**Chain spray, 300 ml**  
The BMW Motorrad chain spray is a fully synthetic lubricant specially developed for motorcycle drive chains.

**Gloss polish, 250 ml**  
The BMW Motorrad gloss polish protects against weather influences and preserves all paint, chrome and plastic parts.

**Metal polish, 75 ml**  
The BMW Motorrad metal polish for unpainted metals not only frees the bike from the city's dirt, but also makes it sparkling clean again.

**Body + Bike shower gel, 250 ml**  
Body + Bike from BMW Motorrad is the first shower gel for rider and vehicle. It removes dirt from the road and is kind to the skin and paint.

**Visor and helmet cleaner, 50 ml**  
The special visor and helmet cleaner removes foreign matter thoroughly and gently from the helmet shell and the visor.

**Helmet pad cleaner, 300 ml**  
The BMW Motorrad helmet pad cleaner removes even stubborn dirt and refreshes the padding in the helmet.

**Functional washing detergent, 250 ml**  
BMW Motorrad functional detergent for high-quality BMW Motorrad clothing, outdoor apparel and sportswear and for microfibre fabrics.

**Waterproofing agent for motorcycle clothing, 300 ml**  
BMW Motorrad impregnation agent for waterproof and oilproof re-impregnation of textiles made of natural and synthetic fibres.



# PREVIOUS MODELS

<b>C MODEL RANGE</b> C 600 Sport, C 650 GT	<b>318</b>	<b>F MODEL RANGE</b> F 800 S, F 800 ST, F 800 GT, F 800 R, F 650 GS, F 800 GS, F 700 GS, F 800 GS, F 800 GS Adventure	<b>414</b>
<b>G MODEL RANGE</b> G 650 GS, G 650 GS Sertao	<b>330</b>	<b>K MODEL RANGE</b> K 1200 R, K 1300 R, K 1200 R Sport, K 1200 S, K 1300 S, K 1200 GT, K 1300 GT, K 1600 GT, K 1600 GTL, K 1600 GTL Exclusive	<b>440</b>
<b>R MODEL RANGE, WATER-COOLED</b> R 1200 GS, R 1200 GS Adventure, R 1200 R, R 1200 RT, R 1200 RS	<b>338</b>	<b>S MODEL RANGE</b> HP4, S 1000 R, S 1000 RR, S 1000 XR	<b>460</b>
<b>R MODEL RANGE, AIR-COOLED</b> R 1200 GS, R 1200 GS Adventure, R 1200 R, R 1200 RT, R 1200 S, R 1200 ST	<b>372</b>		
<b>R MODEL RANGE R NINE T</b>	<b>400</b>		





# C MODEL RANGE

HP PARTS	320	ERGONOMICS & COMFORT	324
STORAGE	321	NAVIGATION & COMMUNICATION	327
DESIGN	323	SAFETY	329

**Vehicle-specific accessories for:**

- C 600 Sport  
Model code 0131, 0132
- C 650 GT  
Model codes 0133, 0134





## HP PARTS

### HP SPORT SILENCER

**Available for:**

- C 600 Sport
- C 650 GT

A top-class feature for top quality sound. The sleek, high-quality titanium slip-on silencer with carbon end-cap delivers a powerful rumble. In addition, the sports silencer developed with Akrapovič is weight-optimised compared to the standard silencer.



## STORAGE

### TOPCASE (35 L) WITH BACKREST PAD

**Available for:**

- C 600 Sport
- C 650 GT

This topcase is mounted on the luggage carrier and offers enough space for a helmet with its volume of 35 litres. The waterproof luggage box is available with lid trims in the same body colour as the Maxi-Scooter itself. The reflector on the lid is standard, the liner, backrest pad and vehicle lock are among the handy options.

The comfortable backrest pad for the 35-litre topcase offers the passenger more comfort both on short trips and long tours.

Only available in conjunction with luggage grid. Not in combination with backrest for passenger. For information on speed and load limitations, please refer to the instruction booklet.

#### 1 Topcase, 35l



#### 2 Topcase, backrest pad



### LUGGAGE GRID

**Available for:**

- C 600 Sport
- C 650 GT

The sturdy, stylish luggage carrier is ideal for reliably securing the topcase or other large items of luggage. An optional backrest can also be fitted to provide additional comfort for the passenger.

To be fitted and/or enabled in a specialist workshop, and ideally at your authorised BMW Motorrad Retailer.





**PARTITION NET FOR LUGGAGE COMPARTMENT**

**1 Available for:**  
• C 600 Sport

The practical partition net for the luggage compartment divides the storage compartment below the seat into one front and one rear section. This is perfect for neatly storing small items. The net can be installed and removed quickly using the buckles. When not in use, the net disappears into the stowage compartment to save space.

**2 Available for:**  
• C 650 GT

To be fitted and/or enabled in a specialist workshop, and ideally at your authorised BMW Motorrad Retailer.

**1 Partition net for luggage compartment**



**2 Partition net for luggage compartment**



**CENTRE TUNNEL BAG**

**Available for:**  
• C 600 Sport  
• C 650 GT

The practical centre tunnel bag offers 12 litres of storage space and can be attached quickly and easily. Above the waterproof main compartment there is a smaller lid compartment which holds all kinds of small parts. The bag is perfectly adapted to the scooter, but thanks to its carry handle and shoulder strap it is also ideal for a stroll around town.



To be fitted and/or enabled in a specialist workshop, and ideally at your authorised BMW Motorrad Retailer.

**DESIGN**

**LED INDICATORS**

**Available for:**  
• C 600 Sport

A shining example: The beautifully designed LED indicators with white turn indicator glass convince with their slim design and modern lighting technology. They respond much faster than incandescent lamps and are virtually wear-free. This provides a clear safety advantage in road traffic. The set includes two LED indicators for retrofitting.

Note the differences in national-market versions.  
To be fitted and/or enabled in a specialist workshop, and ideally at your authorised BMW Motorrad Retailer.

**1 LED flashing turn indicator, installation kit with VVP**



**2 Front LED flashing turn indicator**



**CHROME PARTS**

**1 Available for:**  
• C 650 GT

The chrome-plated footrest inserts and handlebar weights add a classy, personal touch to the maxi-scooter.

**2 Available for:**  
• C 600 Sport  
• C 650 GT

To be fitted and/or enabled in a specialist workshop, and ideally at your authorised BMW Motorrad Retailer.

**2**  
It is not possible to combine the central chrome-plated footrest insert with crash pads.

**3 Available for:**  
• C 600 Sport

**1 Chrome-plated handlebar weight**



**2 Chrome-plated footrest insert**



**3 Chrome-plated rear footrest**



Original BMW Motorrad equipment is available from your authorised BMW Motorrad Retailer.



# ERGONOMICS & COMFORT

## WIND DEFLECTORS

**Available for:**  
• C 650 GT

The black wind deflectors are firmly attached to the trim panel and effectively protect the hands from wind and weather.



## SPORT WINDSCREEN, TINTED

**Available for:**  
• C 650 GT

The tinted Sport windscreen gives the maxi-scooter a personal touch and sporty nuance. The special coating also permanently prevents scratches.

Note the differences in national-market versions. To be fitted and/or enabled in a specialist workshop, and ideally at your authorised BMW Motorrad Retailer.



## SPORT SEAT, HEATED

**Available for:**  
• C 600 Sport

The two-tone colour scheme in black/grey, textured surface and decorative double stitching in blue make the high-quality heated Sport seat a real highlight. The multi-level seat heating can be controlled separately for the rider and passenger and ensures a comfortable ride even on cool days.

To be fitted and/or enabled in a specialist workshop, and ideally at your authorised BMW Motorrad Retailer.

## EXCLUSIVE SEAT

**Available for:**  
• C 650 GT

The two-tone colour scheme in black/grey, textured surface and decorative stitching in Quartz grey make the high-quality heated Exclusive seat a real highlight. The multi-level seat heating can be controlled separately for the rider and passenger and ensures a comfortable ride even on cool days.

To be fitted and/or enabled in a specialist workshop, and ideally at your authorised BMW Motorrad Retailer.



## LOW SEAT

**1 Available for:**  
• C 600 Sport

**2 Available for:**  
• C 650 GT

20 mm lower than the standard version, this low seat makes climbing on off easier and keeps the ground within easy reach. Many riders feel safer thanks to the reduced seat height, because they can manoeuvre and control their scooter more easily. The high-quality surface material in black corresponds to the standard equipment.

**2**  
Not available in conjunction with seat heating. To be fitted and/or enabled in a specialist workshop, and ideally at your authorised BMW Motorrad Retailer.

### 1 Low seat



### 2 Low seat



## HEATED SEAT (NOT SHOWN)

**Available for:**  
• C 600 Sport  
• C 650 GT

The heated seat is the same size as the standard seat with the multi-level seat heating having separate controls for rider and passenger.

To be fitted and/or enabled in a specialist workshop, and ideally at your authorised BMW Motorrad Retailer.

## SCOOTER LEG COVER

**1 Available for:**  
• C 600 Sport

**2 Available for:**  
• C 650 GT

The scooter canopy reliably protects the rider's legs and lower body from water, wind and dirt. The waterproof protective cover can be fastened quickly and securely and is also suitable as additional protection against the cold, thanks to the removable polyester fleece. Zipped pockets and the integrated seat cover perfectly round off the weather protection.

Recommended maximum speed 130 km/h. To be fitted and/or enabled in a specialist workshop, and ideally at your authorised BMW Motorrad Retailer.

### 1 Scooter canopy



### 2 Scooter canopy





RAIN COVER FOR SEAT



**Available for:**  
• C 600 Sport

The snug-fitting rain cover for the seat is waterproof and is fastened using an elastic drawstring under the seat. The hood made of PU-coated nylon is tear-resistant and UV-resistant, making it ideal for all weathers. When not in use, it can be folded down to a compact size and stowed in the practical storage bag.

BACKREST FOR PASSENGER



**Available for:**  
• C 600 Sport  
• C 650 GT

Relaxed feeling on the road even after many kilometres: with the padded backrest the passenger enjoys more comfort on short trips as well as on longer tours. The ride can be enjoyed in a relaxed and even more thorough way. The backrest is attached to the passenger handles and can be used together with the luggage carrier.

Topcase and backrest for passenger cannot be fitted together. To be fitted and/or enabled in a specialist workshop, and ideally at your authorised BMW Motorrad Retailer.

HEATED GRIPS AND MULTIFUNCTION SWITCHES

**Available for:**  
• C 600 Sport  
• C 650 GT

Keep your hands as warm as you like with three-level grip heating (available settings: 1, 2 or Auto based on outside temperature).

To be fitted and/or enabled in a specialist workshop, and ideally at your authorised BMW Motorrad Retailer.



# NAVIGATION & COMMUNICATION

**BMW MOTORRAD NAVIGATOR VI (INCL. 4-BUTTON CRADLE MOUNT)**

**Available for:**  
• C 600 Sport  
• C 650 GT

**1 - 2**  
Only in combination with bracket for navigation systems. Note the differences in national-market versions.

With the multifunction Navigator VI, route planning becomes child's play. The system with 16GB flash memory and a five-inch touch screen always shows the right way, and the waterproof display is easy to read even in direct sunlight. The high-resolution screen provides all the essential information and ensures that you can see the big picture required in every situation. Numerous additional functions make planning and touring an exciting experience. Plan your routes can be created according to your personal preferences and enjoy driving on winding and quiet side roads. In unknown terrain, the "round trip" option is a good choice as it reliably guides the rider at the end of the tour back to the starting point. The Bluetooth connection to the BMW Motorrad communication system and the optional Smartphone Link app enable multimedia on the go: navigation announcements, telephone calls and music streaming as well as the retrieval of weather forecasts or traffic jam information are no problem. Operation is via the stable Mount Cradle; the four buttons can also be accurately controlled while wearing gloves. Choose the pre-installed map data, and you will always be up to date thanks to lifelong, free map updates.

BMW Motorrad navigation devices and the BMW Motorrad smartphone cradle can only be mounted using the BMW Motorrad navigation device bracket.

**1 BMW Motorrad Navigator VI (with 4-button Mount Cradle)**



**2 BMW Motorrad Smartphone Cradle**



**3 Bracket for BMW Motorrad navigation systems**



Original BMW Motorrad equipment is available from your authorised BMW Motorrad Retailer.



**MOBILE PHONE STORAGE**

**1 Available for:**  
• C 600 Sport

The custom-fit insert for the storage compartment offers space for a mobile phone and other small items. If the BMW USB charger is available on board, the smartphone can be charged while riding. The handy insert has a number of compartments. It can be locked, is waterproof and ensures that items are safely stowed.

**2 Available for:**  
• C 650 GT

**1 Mobile phone insert for storage compartment**



**2 Mobile phone insert**



**SAFETY**

**ASPHERICAL MIRROR**

**Available for:**  
• C 650 GT

The aspherical mirror glass with its curved surface enlarges the field of view and almost completely eliminates the blind spot. Objects that disappear in the blind spot with conventional mirrors remain largely visible with aspherical mirrors, even though they are almost at the same height.



**CRASH PADS**

**Available for:**  
• C 650 GT

The drop-protection pads made of robust plastic protect the Scooter from damage in the case of a fall. The abrasion-resistant pads are screwed to the trim panel at the front and the footboards at the rear, and offer effective protection if the bike should fall over or in the event of a fall at low speed.



**SCOOTER LOCK**

**Available for:**  
• C 600 Sport  
• C 650 GT

This scooter lock is a quick and effective solution for theft protection. With the sheathed chain made of ultra-hard steel, the handlebar end of the Maxi-Scooter can be fixed to the swinging arm or a fixed object in no time at all. When not in use, the lock can be stowed under the seat in the storage bag provided.

Use of chrome-plated handlebar weight is restricted (scooter lock fastener takes the place of left handlebar weight). To be fitted and/or enabled in a specialist workshop, and ideally at your authorised BMW Motorrad Retailer.



**ANTI-THEFT ALARM SYSTEM RETROFIT SET (NOT SHOWN)**

**Available for:**  
• C 600 Sport  
• C 650 GT

The anti-theft alarm system reacts to changes in position and vibrations with a clearly audible signal and a flashing warning lights system. Thanks to the warning, passers-by quickly become aware. The system is conveniently activated by remote control.

Note the differences in national-market versions. To be fitted and/or enabled in a specialist workshop, and ideally at your authorised BMW Motorrad Retailer.



# G MODEL RANGE

STORAGE	332
ERGONOMICS & COMFORT	334
SAFETY	336

**Vehicle-specific accessories for:**

- G 650 GS  
Model codes 0178, 0179, 0188, 0189
- G 650 GS Sertao  
Model code 0136, 0146





# STORAGE

## VARIABLE CASES

**Available for:**

- G 650 GS
- G 650 GS Sertao

The splash-proof plastic cases have an adjustment mechanism that allows the case volume to be adapted to current requirements. The case is narrower when capacity is reduced, which is useful in city traffic. The capacity on both sides is 19 to 28l each.



## TOPCASE, 31L

**Available for:**

- G 650 GS
- G 650 GS Sertao

The topcase attaches quickly and easily to the standard luggage grid. There's even space for a helmet inside.



## CASE RACK

**Available for:**

- G 650 GS
- G 650 GS Sertao

To be fitted and/or enabled in a specialist workshop, and ideally at your authorised BMW Motorrad Retailer.



## TANK BAG, 13-17L

**Available for:**

- G 650 GS
- G 650 GS Sertao

The tank bag is shaped for a snug fit on the motorcycle and has a waterproof main compartment. The map compartment and exterior pocket are highly water-resistant. An all-round zip increases capacity from 13l to 17l.



## LINER FOR VARIABLE CASES

**Available for:**

- G 650 GS
- G 650 GS Sertao

The practical, waterproof liner with removable carry strap keeps its contents well protected.

Variable cases, left and right, can be used on both sides.



## LINER FOR TOPCASE

**Available for:**

- G 650 GS

A highly water-resistant, easy-to-pack liner that you can use to carry luggage to and from your motorcycle. This eliminates the need to remove the topcase.





# ERGONOMICS & COMFORT

## WINDSCREENS

**Available for:**

- G 650 GS
- G 650 GS Sertao

Improves protection against wind and rain, especially on longer journeys. Tinted version also available.

**2** Not available for G 650 GS

**3** Not available for G 650 GS

**1** High windscreen

**2** High windscreen, tinted

**3** Low windscreen, tinted

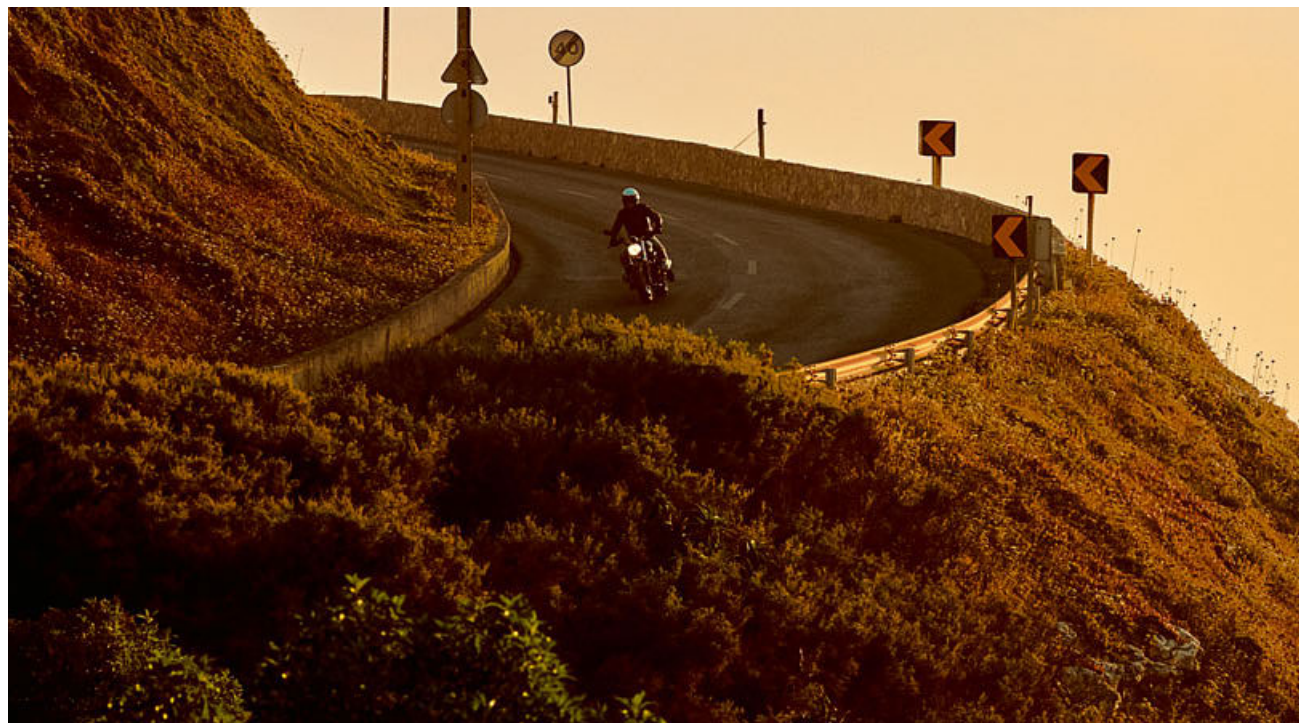

## HIGH SEAT

**Available for:**

- G 650 GS
- G 650 GS Sertao

40 mm higher than the standard version, this padded seat provides a more comfortable seating position for taller riders.



## CENTRE STAND

**Available for:**

- G 650 GS

The centre stand makes refuelling easier and ensures your motorcycle takes up less parking space.

Only in conjunction with lowered suspension.



## HEATED GRIPS (NOT SHOWN)

**Available for:**

- G 650 GS
- G 650 GS Sertao

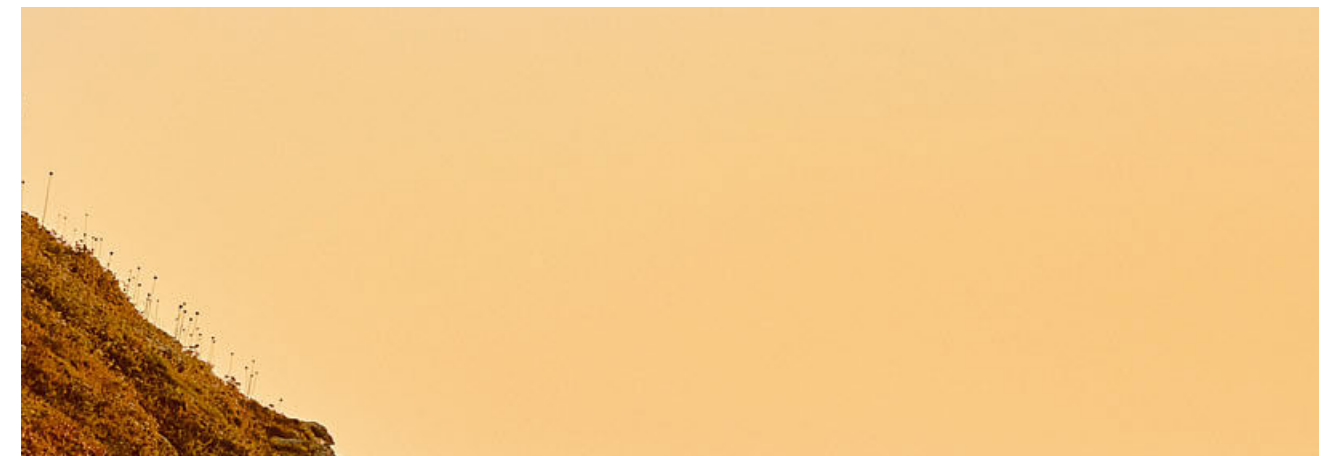



# SAFETY

## HAND PROTECTORS

**Available for:**

- G 650 GS
- G 650 GS Sertao

For effective protection against low branches and flying stones. Also helps shield the rider from wind in cold weather.



## ALUMINIUM ENGINE GUARD

**Available for:**

- G 650 GS
- G 650 GS Sertao

In situations where impacts are unavoidable, the engine protection bar effectively helps prevent damage.





# R MODEL RANGE WATER-COOLED

HP PARTS	340	NAVIGATION & COMMUNICATION	367
STORAGE	342	SAFETY	368
DESIGN	357	MAINTENANCE & TECHNOLOGY	371
ERGONOMICS & COMFORT	360		

#### Vehicle-specific accessories for:

- R 1200 R  
Model codes 0A03, 0A14
- R 1200 RT  
Model codes 0A03, 0A13
- R 1200 RS  
Model codes 0A05, 0A15
- R 1200 GS  
Model codes 0A01, 0A11, 0A51, 0A61
- R 1200 GS Adventure  
Model codes 0A02, 0A12





# HP PARTS

## HP SPORT SILENCER

**1 Available for:**

- R 1200 R
- R 1200 RS

The high-end titanium-clad silencer delivers an impressively rich sound and is a clear avowal to racing, both visually and acoustically.

**2 Available for:**

- R 1200 GS
- R 1200 GS Adventure

**2**  
Please note the specifications for different countries.

**HP Sports silencer (not shown) available for:**

- R 1200 RT

**HP Sports silencer (not shown) available for:**

- R 1200 GS
- R 1200 GS Adventure

Not available for model codes 0A51, 0A61

1 HP sports silencer



2 HP sports silencer



## HP HAND LEVERS

**Available for:**

- R 1200 R
- R 1200 RT
- R 1200 RS
- R 1200 GS
- R 1200 GS Adventure

The HP hand levers made of anodised aluminium emphasise the sportiness of the bike and can be ergonomically adjusted to the hand width in five (brake lever) or three (clutch lever) steps. They are milled from a high-strength aluminium alloy that is completely resistant to corrosion and integrate perfectly into the bike's sporty design in terms of colour.



To be fitted and/or enabled in a specialist workshop, and ideally at your authorised BMW Motorrad Retailer.

## HP CARBON HEAT GUARD

**Available for:**

- R 1200 R
- R 1200 RS

The high-quality HP Carbon cover acts as a heat protection and at the same time emphasises the sporty look of the sport silencer. The lightweight CFRP component for vehicles with a centre stand is sealed with UV-resistant high-gloss paint and adds a further sporty nuance.

To be fitted and/or enabled in a specialist workshop, and ideally at your authorised BMW Motorrad Retailer.

1 HP Carbon heat protection (for vehicles with a centre stand)



2 HP Carbon heat protection (for vehicles without a centre stand)



Original BMW Motorrad equipment is available from your authorised BMW Motorrad Retailer.



# STORAGE

## ALUMINIUM CASES

**Available for:**

- R 1200 GS
- R 1200 GS Adventure

Only available for model codes 0A01, 0A11

The perfect solution for touring fans who place the highest demands on themselves and their equipment: the aluminium case for mounting on the left-hand side offers 44 litres of storage space. The aluminium case for mounting on the right-hand side offers 36 litres of storage space. This robust piece of transport equipment is dust- and waterproof. Many practical details impress even under extreme conditions.

Not available in conjunction with LED indicators at the rear with short base TNR 8 522 499; install LED indicators with long base TNR 8 522 500 if necessary. For information on individual speed and load restrictions, please refer to the instruction booklet.

1 Aluminium case



3 Aluminium case



## ALUMINIUM TOPCASE AND BACKREST PAD

**Available for:**

- R 1200 GS
- R 1200 GS Adventure

Only available for model codes 0A01, 0A11

The waterproof topcase has a capacity of 32 litres and lashing eyes for securing additional luggage. And with the optional backrest pad added, it provides increased comfort for the passenger.

For information on speed and load limitations, please refer to the instruction booklet.

1 Aluminium topcase, 32l



2 Aluminium topcase, black, 32l



3 Backrest pad



## CASE AND TOPCASE RACK FOR ALUMINIUM CASE AND ALUMINIUM TOPCASE

**Available for:**

- R 1200 GS
- R 1200 GS Adventure

Only available for model codes 0A01, 0A11

The aluminium side cases and the Atacama side bags can be easily and securely attached to the sturdy case rack made of polished or black powder-coated stainless steel. In addition to a typical Enduro appearance, the case rack also serves as a traction point for off-road use.

The aluminium topcase or other pieces of luggage can be attached to the topcase carrier. In addition, the luggage grid can be used as a grip for Enduro use.

**1 & 2**

Not available in conjunction with Rallye seat with luggage grid. Only available in conjunction with part number 77 30 8 546 226 (cover kit for holes for grab handles) if the standard passenger grab handles have been removed.

**2 & 4**

When used with aluminium cases, the black coating rubs off at the contact points.

1 Case holders for aluminium cases



2 Black case holders for aluminium cases



3 Topcase carriers for aluminium topcases



4 Black topcase carrier for aluminium topcases



## CARRY HANDLE FOR ALUMINIUM CASE / TOPCASE

**Available for:**

- R 1200 GS
- R 1200 GS Adventure

Only available for model codes 0A01, 0A11

Convenient and functional: The practical carry handles for aluminium cases and topcases make it easy to transport the luggage to and from the bike. If the cases are mounted, additional luggage can also be attached to the handles.





**LINER FOR ALUMINIUM CASES AND ALUMINIUM TOPCASES**



**Available for:**  
 • R 1200 GS  
 • R 1200 GS Adventure  
 Only available for model codes 0A01, 0A11

The waterproof liner for the aluminium case or the aluminium topcase gets the luggage organised and facilitates loading and unloading. The carry handle and shoulder strap make the bag easy to access and transport. Alternatively, the sturdy bag can also be attached to the outside of the case, creating additional storage space.

**LUGGAGE COMPARTMENT SEPARATING NET FOR ALUMINIUM CASES**



**Available for:**  
 • R 1200 GS  
 • R 1200 GS Adventure  
 Only available for model codes 0A01, 0A11

The luggage net for aluminium cases and topcases creates more order and makes it easier to access frequently used items. The highly flexible net is attached to the inside of the lid and ensures that luggage such as raincoats, folding backpacks, toiletry bags and sneakers are always at hand when the case is opened.

**VARIABLE CASES**

**Available for:**  
 • R 1200 GS  
 • R 1200 GS Adventure

With its patented adjustment mechanism, the variable case offers stowage space of 30 to 39 litres (left) or 20 to 29 litres (right). The adjustable volume offers benefits, especially in city traffic, as the width of the case can be reduced at the same time. Naturally the variable case is waterproof and also suitable for off-road use.

1 Variable case, left, 30–39l



2 Variable case, right, 20–29l



**VARIABLE TOPCASE**

**Available for:**  
 • R 1200 GS

The variable topcase with its patented adjustment mechanism offers a variable volume from 25 to 35 litres. The variable topcase, made of robust plastic, is waterproof, suitable for off-road use and has a large GS inscription.

the comfortable backrest pad for the large topcase offers the passenger more comfort both on short trips and on long tours.

1 Variable topcase, 25–35l



2 Variable topcase, silver



3 Backrest pad for variable topcase



**LINER FOR VARIABLE CASE VARIABLE TOPCASE**

**Available for:**  
 • R 1200 GS  
 • R 1200 GS Adventure

The liner gets the luggage organised and facilitates loading and unloading. The bag is quick to hand and easy to carry thanks to the carry handle and shoulder strap. Practical details include the mesh partition with a zipped compartment in the lid and the volume which can be varied by an all-round zip.

**CASE HOLDERS FOR VARIABLE CASES**

**Available for:**  
 • R 1200 GS  
 • R 1200 GS Adventure

The variable cases can be easily and securely attached to the sturdy case racks on both sides of the motorcycle. The racks are perfectly integrated into the overall appearance of the motorcycle.





**CASE RACK FOR VARIABLE CASES IN BLACK**

**Available for:**

- R 1200 GS
- R 1200 GS Adventure

The variable cases can be easily and securely attached to the sturdy case racks on both sides of the motorcycle. The racks are perfectly integrated into the overall appearance of the motorcycle.



**LUGGAGE GRID FOR PASSENGER SEAT**

**Available for:**

- R 1200 GS
- R 1200 GS Adventure

The luggage grid made of black painted plastic replaces the passenger seat and offers the ideal basis for safely transporting luggage. In combination with the variable cases, the result is a wide, flat packing surface on which even larger objects can be secured close to the vehicle's centre of gravity.

Not available in conjunction with Rallye seat with luggage grid. Only available in conjunction with part number 77 30 8 546 226 (cover kit for holes for grab handles) if the standard passenger grab handles have been removed.



**TOURING CASES**

**Available for:**

- R 1200 R
- R 1200 RS

With a volume of 32 litres, the high-quality hard shell touring case offers ample space for luggage or the motorcycle helmet. The splashproof case with painted lid in Black storm metallic can be locked and is the perfect travel companion for short or longer tours.

**1 & 3**

For information on speed and load restrictions, please refer to the instruction booklet.

**1 Touring case, Black storm metallic**



**2 Touring case, Granite grey metallic matt**



**3 Touring case, Light white matt**



**TOURING TOPCASE**

**Available for:**

- R 1200 R
- R 1200 RS

This high-quality touring topcase with backrest pad and full equipment offers 49 litres of storage space. The waterproof luggage box with painted lid has two gas pressure dampers, interior lighting and carpet lining. The lock can be conveniently operated via central locking. The maximum load is 10 kg.

This high-quality light touring topcase with backrest pad offers a large storage space of 49 litres.

**5**

To be fitted and/or enabled in a specialist workshop, and ideally at your authorised BMW Motorrad Retailer.

**1 Blue planet touring topcase, 49l**



**2 Light white aluminium touring topcase, 49l**



**3 Sparkling storm metallic touring topcase, 49l**



**4 Carbon black metallic touring topcase, 49l**



**5 Backrest pad for touring topcase, brown**



**ADDITIONAL BRAKE LIGHT FOR TOURING TOPCASE**

The additional brake light for the touring topcase with modern LED technology in a white clear-glass look blends perfectly with the existing topcase lid embellisher. Because braking activity can be seen better, this promotes passive safety in traffic.

To be fitted and/or enabled in a specialist workshop, and ideally at your authorised BMW Motorrad Retailer.





**CASE RACK**

**Available for:**

- R 1200 R
- R 1200 RS

The touring case can be easily and securely attached to the sturdy black powder-coated steel case rack.



**IMPACT PROTECTION FOR TOURING CASES AND PROTECTIVE FILM**

**Available for:**

- R 1200 RT

The impact protection is made of sturdy plastic, protects the touring case at the front, bottom and sides from scratches and damage. The two moulded parts therefore serve well when the bike has to be manoeuvred into tight parking spaces or narrow passages. But even when transported by hand, the impact protection can take a bump or two.

The self-adhesive and transparent film protects top and side surfaces of touring cases from small scratches.

**Protective film for touring case (not shown)**

To be fitted and/or enabled in a specialist workshop, and ideally at your authorised BMW Motorrad Retailer.



**LINER FOR TOURING CASE AND TOURING TOPCASE**

**1 Available for:**

- R 1200 R
- R 1200 RS

The matching liner for the touring topcase gets the luggage organised and facilitates loading and unloading. The carry handle and shoulder strap make the bag easy to access and transport. Practical details include two external patch pockets and a wide-opening lid.

**2 - 4 Available for:**

- R 1200 RT

The handy, high-quality liner is water-resistant and makes full use of the capacity of the topcase. So while the liner is being used, space within the storage compartment for the topcase will be limited.

**1 Liner for touring case**



**2 Liner for touring topcase**



**3 Storage compartment for touring topcase**





**TANK BAG SMALL, 5-9 L**

**Available for:**

- R 1200 R
- R 1200 RS

The small tank bag made of durable PU-coated polyester fabric is the ideal companion for short trips. The waterproof main compartment with liner, the exterior pocket, the volume that can be expanded from 5 to 9 litres, the carry handle and the removable shoulder strap are functional features that meet all your everyday needs.



**SMALL TANK BAG, 8 L**

**Available for:**

- R 1200 GS

The small tank bag made of PVC-coated polyester fabric with belt attachment is the ideal companion for short trips. The waterproof main compartment with an liner offers intelligent details such as the cable duct and fastening loops for the waterproof A4 map pocket and has a volume of 8 litres.

For information on speed and load restrictions, please refer to the instruction booklet.



**LARGE TANK BAG, 11-15 L  
(NOT SHOWN)**

**Available for:**

- R 1200 GS

The tank bag, made of durable PVC-coated polyester fabric with a waterproof main compartment and belt attachment, offers many intelligent details; its volume can be extended from 11 to 15 litres as required. Extra space is available with the map pocket and an exterior pocket with bottle holder.

For information on speed and load restrictions, please refer to the instruction booklet.

**TANK BAG, 12-16 L**

**Available for:**

- R 1200 GS Adventure

The tank bag made of PVC-coated polyester fabric offers clever details and can be extended from 12 to 16 litres as required. Extra space is available with the map pocket and an exterior pocket. The smart fastener design guarantees a secure hold and extremely functional handling.

For information on speed and load restrictions, please refer to the instruction booklet.



**MAP POCKET FOR TANK BAG**

**Available for:**

- R 1200 GS

Even today, many tour riders do not want to do without reliable road maps. The ideal solution is the removable map pocket in A4 format with waterproof roll closure. It can be fastened securely to the tank bag with hook and loop fasteners; the stiffened bottom prevents it from flapping in the oncoming wind.

For information on speed and load restrictions, please refer to the instruction booklet.



**BAG FOR FRAME**

**Available for:**

- R 1200 R
- R 1200 RS
- R 1200 GS
- R 1200 GS Adventure

The lined pocket made of PVC-coated polyester fabric is attached to the frame below the rider's seat and does not restrict freedom of movement. Now smaller items are also always on board while on the road. The water-repellent zip fastener with non-slip zipper allows quick access.



**POCKET FOR WIND DEFLECTOR**

**Available for:**

- R 1200 GS
- R 1200 GS Adventure

The high-quality pockets made of PVC-coated polyester fabric are attached behind the trim panel and thus allow quick access to the contents. The lined storage space is particularly suitable for smaller items such as smartphones up to 5 inches, which are safe and protected there.





ATACAMA LUGGAGE SYSTEM

**1 & 3 available for:**

- R 1200 R
- R 1200 RT
- R 1200 RS
- R 1200 GS
- R 1200 GS Adventure

The Atacama side bags convince with clever details and a combined storage volume of 60 litres. In addition to the waterproof liners, various storage compartments provide additional space. Quick-release fasteners for easy mounting on the motorcycle and sturdy carry handles ensure a secure hold and extremely practical handling.

**2 & 4 & 5 available for:**

- R 1200 GS
- R 1200 GS Adventure

The Atacama luggage roll made of a robust mix of materials convinces with clever details and a storage volume of 40 litres. In addition to the waterproof liner, various storage compartments provide additional space. The versatile fastening concept, three carry handles and backpack function ensure a secure hold and extremely practical handling.

The Atacama side bags and roll bag and other pieces of luggage or helmets can be secured to the motorcycle using the lockable tension straps with steel core.

**1 & 2**

For information on speed and load limitations, please refer to the instruction booklet.

**2**

Only available in conjunction with case rack for aluminium cases.

**1 Atacama luggage roll, 40l**



**2 Atacama side bags**



**3 Tensioning strap for Atacama roll bag, lockable**



**4 Atacama side bag adapter**



**5 Tensioning straps for Atacama side bags, lockable**



BAG FOR PASSENGER SEAT, 14-18 L

**Available for:**

- R 1200 GS

With a volume of 14 to 18 litres, this durable bag for the passenger seat offers enough storage space for the daily ride to work or for day trips. The three-sided zip fastener allows quick access, while the functional carrying handle facilitates transport.

For information on speed and load restrictions, please refer to the instruction booklet.



BAG FOR PASSENGER SEAT, 16 L

**Available for:**

- R 1200 R
- R 1200 RS

With a volume of 16 litres, this durable bag for the passenger seat offers enough storage space for the daily ride to work or for day trips. The three-sided zip fastener allows quick access, while the functional carrying handle facilitates transport.





ADDITIONAL BAG UNDER LUGGAGE GRID

Available for:  
• R 1200 GS

The small and practical bag made of durable polyester fabric with a PVC coating creates additional stowage space under the luggage grid. This means that smaller items that the rider does not want to do without on the road are always on board.

Not available in conjunction with the aluminium luggage grid.



LARGE TOPCASE, 49L

Available for:  
• R 1200 GS

The waterproof topcase with painted lid offers storage space of 49 litres and has ample space for up to two helmets.

the comfortable backrest pad for the large topcase offers the passenger more comfort both on short trips and on long tours.

**1**  
Only available in conjunction with luggage grid and topcase rack.

1 Large topcase, 49l



2 Backrest pad for large topcase



LINER FOR LARGE TOPCASE

Available for:  
• R 1200 GS

The matching liner for the large topcase gets the luggage organised and facilitates loading and unloading. The carry handle and shoulder strap make the bag easy to access and transport. Practical details include two external patch pockets and the three-sided all-round zipper.

Not available in conjunction with the aluminium luggage grid.



SMALL TOPCASE, 30 L

Available for:  
• R 1200 R  
• R 1200 RS

The waterproof plastic topcase offers enough space for a helmet with a volume of 30 litres. The lid, which is available in Asphalt Grey metallic matt, Black Storm metallic or Light White, and the soft-close hinges, which allow the lid to be lowered gently, underline the high-quality appeal.

**1**  
Only available in conjunction with luggage carrier, topcase carrier and matching outer shell. For information on speed and load limitations, please refer to the instruction booklet. For more detailed information, contact your authorised BMW Motorrad Retailer or go online at [bmw-motorrad.com](http://bmw-motorrad.com).

1 Small topcase, 30l



2 Backrest pad for small topcase



LINER FOR SMALL TOPCASE, 30L

Available for:  
• R 1200 GS

The matching tailored liner for the topcase gets the luggage organised and facilitates loading and unloading. The carry handle and shoulder strap make the bag easy to access and transport. The practical details include the outside pocket and the three-sided zipper.

SMALL TOPCASE, 28 L

Available for:  
• R 1200 RT

With a volume of 28 litres, the waterproof topcase offers enough space for a helmet and impresses in daily use and on short tours. It is made of a hard-wearing plastic mix in a double-shell design. Its weight is approx. 5.5 kilograms. Backrest pad also available.

1 Small topcase, 28l



2 Backrest pad





LINER FOR SMALL TOPCASE, 28 L

**Available for:**  
• R 1200 RT

The matching liner for the small topcase gets the luggage organised and facilitates loading and unloading. The carry handle and shoulder strap make the bag easy to access and transport. Practical details include the three-sided all-round zipper.



LUGGAGE GRID

**Available for:**  
• R 1200 R  
• R 1200 RS

The sturdy, stylish luggage carrier is ideal for reliably securing the topcase or other large items of luggage. It acts as a full grip for the passenger and is also ideal for use as a pushing aid when manoeuvring.



DESIGN

GS DECOR STICKER SET

**1 Available for:**

• R 1200 GS  
Only available for model codes 0A01, 0A11

**2 Available for:**

• R 1200 GS  
Only available for model codes 0A51, 0A61

**3 Available for:**

• R 1200 GS Adventure

The sticker set in Racing Red and Blackstorm Metallic is perfectly tailored to your vehicle.

These highly durable stickers really stand out thanks to their vivid and metallic colour effects. The pack comes with instructions and application aids so they can be easily applied without creating air bubbles.

**Set contents:**

- Sticker set for: Mudguard, fuel tank, case, topcase, aluminium rims (K50) + spoked rims with rim base décor
- Application aids: Smoothing blade, application fluid, cleaning cloth
- Application instructions

1 GS decorative sticker set



1 GS sticker set



2 GS Adventure sticker set





**BLACK REAR FOOTREST BRACKET**

**Available for:**

- R 1200 GS
- R 1200 GS Adventure

**"STYLE" BLACK RADIATOR COWLS**

**Available for:**

- R 1200 GS

The stainless steel "Style" radiator grilles are not only resistant to detergents due to their black coating, but also their colour does not fade even in direct sunlight. Together with the other optional equipment in Black, they emphasise the dynamic character of the bike.

**EXTENDED FRONT FRONT-WHEEL COVER**

**Available for:**

- R 1200 GS
- Only available for model codes 0A51, 0A61

The larger front-wheel cover emphasises the BMW R 1200 GS's Enduro style and offers improved spray protection.



**LED INDICATORS**

**Available for:**

- R 1200 R
- R 1200 RS
- R 1200 GS
- R 1200 GS Adventure

A shining example: The beautifully designed LED indicators with white turn indicator glass convince with their slim design and modern lighting technology. They respond much faster than incandescent lamps and are virtually wear-free. This provides a clear safety advantage in road traffic. The set includes two LED indicators for retrofitting.

Note the differences in national-market versions.  
To be fitted and/or enabled in a specialist workshop, and ideally at your authorised BMW Motorrad Retailer.



**ENGINE SPOILER**

**Available for:**

- R 1200 R
- R 1200 RS



**CHROME PARTS**

**Available for:**

- R 1200 RT

Choose the look you want: these elegant, high-quality chrome parts can be combined as you wish, giving your BMW R 1200 RT a unique, stylish edge.

**2-4**

To be fitted and/or enabled in a specialist workshop, and ideally at your authorised BMW Motorrad Retailer.

**1 Chrome-plated rear silencer**



**2 Chrome-plated case strip**



**3 Touring topcase lid trim, chrome-plated**





# ERGONOMICS & COMFORT

## WINDSCREENS AND WIND DEFLECTOR

**1 Available for:**  
• R 1200 GS Adventure

The high, tinted windscreen underlines the sporty character of the machine. The scratch-resistant coating ensures long-term durability.

**2 & 5 & 6 Available for:**  
• R 1200 R

The scratch-resistant coated windscreen is higher and wider than the Sport windscreen and noticeably improves wind and weather protection for the rider.

**3 & 4 Available for:**  
• R 1200 GS.  
Only available for model codes A051, A061

The Rallye windscreen was specially developed for off-road use. It is small enough to give the rider a clear view of the terrain and yet offers protection and freedom of movement when riding in a standing position. The Enduro-specific appearance underlines the machine's off-road potential.

**7 Available for:**  
• R 1200 GS  
• R 1200 GS Adventure

The tinted Sport windscreen noticeably relieves the wind pressure on the upper body and adds a sporty nuance.

**8 & 9 Available for:**  
• R 1200 RT

The Sport windscreen in clear glass has a scratch-resistant coating and noticeably relieves the wind pressure on the upper body.

**Windscreen, tinted (not shown) available for:**  
• R 1200 RS

The tinted windscreen underlines the motorcycle's sporty look and ensures lasting transparency thanks to its scratch-resistant coating.

The convenient windscreen offers maximum wind and weather protection for rider and passenger.

Measuring 681 mm, this low windscreen is shorter than the standard windscreen and gives the bike a sporty look.

**1 & 7**  
Note the differences in national-market versions.  
To be fitted and/or enabled in a specialist workshop, and ideally at your authorised BMW Motorrad Retailer.

4 Rallye windscreen, tinted



5 Sport windscreen, tinted



6 Sport windscreen



7 Windscreen, tinted



8 Comfort windscreen



9 Low windscreen



1 High windscreen, tinted



2 High windscreen



3 Rallye windscreen





RIDER SEATS R 1200 GS / R 1200 GS ADVENTURE

**1 Available for:**  
• R 1200 GS

**9 Available for:**  
• R 1200 GS Adventure

**2 - 5 & 8 available for:**  
• R 1200 GS  
• R 1200 GS Adventure

**Rider seat, blue/black (not shown) available for:**  
• R 1200 GS Adventure

**6 & 7 Available for:**  
• R 1200 GS  
Only available for model codes 0A51, 0A61

Only available in conjunction with appropriate passenger or rider seat.  
Except for rider seat (standard), exclusive high rider seat, comfort high and low rider seat

1 Rider seat (standard)



2 Exclusive rider seat, high



3 Exclusive rider seat, low



4 Exclusive rider seat



5 Rider seat, high



6 Comfort rider seat, high



7 Comfort rider seat, low



8 Rider seat, low



9 Rider seat, olive grey/black



RIDER SEATS R 1200 GS / R 1200 GS ADVENTURE

**1 - 3 Available for:**  
• R 1200 RT

The rider seat in black is 20 mm higher and offers particularly tall riders noticeably better seating comfort.

**4 - 7 Available for:**  
• R 1200 R  
• R 1200 RS

20 mm lower than the standard version, this black rider's seat makes climbing on and off easier and keeps the ground within easy reach.

**High rider seat & rider seat & low rider seat, black optional with seat heater (not shown) available for:**  
• R 1200 RT

The rider seat in classic black can be adjusted and has the same seat height as the standard seat.

Rider seats and passenger seats are also available with seat heating.

1 High rider seat, black



2 Low rider seat, black



3 Rider seat, black



4 High rider seat, black



5 Low rider seat, black



6 Sport rider seat, black



7 Rider seat, black





PASSENGER SEATS

Available for:

- R 1200 GS
- R 1200 GS Adventure

Thanks to the smooth but very dimensionally stable soft-touch insert, the Exclusive passenger seat offers a noticeable improvement in seating comfort and invites the passenger to get on. The seat is also available in a narrow design.

Thanks to an additional soft-touch foam layer, the Comfort passenger seat provides noticeably greater seating comfort and even more carefree kilometres for the passenger. The soft, structured cover with decorative seams and exclusive design ensure a high-quality look.

Only available in conjunction with appropriate passenger or rider seat.

1 Exclusive passenger seat



2 Comfort passenger seat



RALLYE SEAT LUGGAGE PLATE

Available for:

- R 1200 GS
- R 1200 GS Adventure

The narrow and harder padded Rallye seat is tailor-made for off-road use and offers the rider maximum freedom of movement in off-road conditions. There is still room for the passenger. On the small luggage plate with a GS inscription, objects can be attached close to the vehicle's centre of gravity.

1  
Not available in conjunction with luggage plate.

1 High Rallye seat with luggage plate



2 Low Rallye seat with luggage plate



FOOTRESTS AND FOOT LEVER

1 - 3 Available for:

- R 1200 GS
- R 1200 GS Adventure

The spring-loaded rider footrest with plastic footplate is adjustable in three positions and offers maximum comfort and surefootedness on and off-road. This means additional stability and even better control of the motorcycle when riding in a standing position, especially off-road.

The wider and longer Enduro footrest offers more grip and allows better off-road vehicle control.

To be fitted and/or enabled in a specialist workshop, ideally at your authorised BMW Motorrad Retailer.

1 Adjustable rider footrest, black



2 Adjustable rider footrest



3 Enduro footrest



ADJUSTABLE FOOTBRAKE LEVER

Available for:

- R 1200 R
- R 1200 RS

The height-adjustable footbrake lever has a wider step and a patented folding mechanism. The footbrake can be suitably adjusted for even better operation and control, especially when driving off-road while standing. Height adjustment can be done without tools.



CENTRE STAND

Available for:

- R 1200 R
- R 1200 RT
- R 1200 RS

The stable centre stand ensures a safe stand for the motorcycle even on slopes and offers advantages, for example, when refuelling, mounting cases and topcases or checking tyre pressure. The motorcycle also takes up less space when parked upright.





**PRO GEAR-SHIFT ASSIST**

**Available for:**

- R 1200 R
- R 1200 RT
- R 1200 RS
- R 1200 GS
- R 1200 GS Adventure

The shift assistant Pro allows shifting up and down in almost all load ranges and engine speed ranges without actuating the clutch or throttle. The assistant thus ensures noticeably reduced shifting times, a relief of the clutch hand and thus greater comfort and dynamics.



**CRUISE CONTROL RETROFIT SET (NOT SHOWN)**

**Available for:**

- R 1200 R
- R 1200 RT
- R 1200 RS
- R 1200 GS
- R 1200 GS Adventure

The electronic cruise control can be activated from 30 km/h and keeps the driving speed constant. This makes it possible to enjoy longer motorway stretches in a relaxed style. The function is deactivated on braking, and the selected speed is automatically adopted after activating the Resume button

To be fitted and/or enabled in a specialist workshop, ideally at your authorised BMW Motorrad Retailer.

**PRO RIDING MODES RETROFIT SET (NOT SHOWN)**

**Available for:**

- R 1200 R
- R 1200 RT
- R 1200 RS
- R 1200 GS
- R 1200 GS Adventure

The Pro riding modes can be retrofitted using an enabling code. Riders of older motorcycles therefore do not have to do without modern safety features. Depending on the year of manufacture, retrofitting is possible with the Pro, Pro with DTC or Pro with ABS Pro, DTC and HSC modes.

To be fitted and/or enabled in a specialist workshop, ideally at your authorised BMW Motorrad Retailer.

**HILL START CONTROL RETROFIT SET (NOT SHOWN)**

**Available for:**

- R 1200 R
- R 1200 RT
- R 1200 RS
- R 1200 GS
- R 1200 GS Adventure

The Hill Start Control (HSC) drive-off assistant can be retrofitted using an enabling code. Therefore, the driver does not have to do without the convenient assistance system. HSC makes stopping and starting on slopes easier and offers valuable support, especially when the bike has a full load.

To be fitted and/or enabled in a specialist workshop, ideally at your authorised BMW Motorrad Retailer.

**HEATED GRIPS AND SWITCHES (NOT SHOWN)**

**Available for:**

- R 1200 R
- R 1200 RT
- R 1200 RS
- R 1200 GS
- R 1200 GS Adventure

Comfort meets safety. The practical heated grip keeps hands pleasantly warm even on cold days, while being even more responsive. The grip heating controlled by the on-board computer continuously detects the outside temperature via sensors and adjusts the heat output.

To be fitted and/or enabled in a specialist workshop, ideally at your authorised BMW Motorrad Retailer.

# NAVIGATION & COMMUNICATION

**BMW MOTORRAD NAVIGATOR VI (INCL. 4-BUTTON CRADLE MOUNT)**

**Available for:**

- R 1200 R
- R 1200 RT
- R 1200 RS
- R 1200 GS
- R 1200 GS Adventure

With the multifunctional Navigator VI, route planning becomes child's play. The system with 16 GB flash memory and a five-inch touch screen always shows the right way, and the waterproof display is easy to read even in direct sunlight. The high-resolution screen provides all the essential information and ensures that you can see the big picture required in every situation. Numerous additional functions make planning and touring an exciting experience. Plan your routes can be created according to your personal preferences and enjoy driving on winding and quiet side roads. In unknown terrain, the "round trip" option is a good choice as it reliably guides the rider at the end of the tour back to the starting point. The Bluetooth connection to the BMW Motorrad communication system and the optional Smartphone Link app enable multimedia on the go: navigation announcements, telephone calls and music streaming as well as the retrieval of weather forecasts or traffic jam information are no problem. Operation is via the stable Mount Cradle; the four buttons can also be accurately controlled while wearing gloves. Choose the pre-installed map data, and you will always be up to date thanks to lifelong, free map updates.

**1**  
Also available as optional equipment, option code 272

**2**  
Note the differences in national-market versions. Only available in conjunction with OE navigation preparation.

**1 Retrofit set preparation for navigation device**



**2 BMW Motorrad Navigator VI**



**AUDIO SYSTEM RETROFIT SET (NOT SHOWN)**

**Available for:**

- R 1200 RT

The audio system with radio function has MP3 player, iPod and USB stick interfaces. Operation is via the Multi-Controller on the handlebars or the radio control panel. The station, the current music track or the selected volume are displayed on the info screen.

Please note the specifications for different countries.



# SAFETY

## ENDURO ALUMINIUM ENGINE GUARD



- Available for:**
- R 1200 GS
  - R 1200 GS Adventure

The robust aluminium Enduro engine guard provides effective protection against stone chip and damage, especially in off-road use.

To be fitted and/or enabled in a specialist workshop, ideally at your authorised BMW Motorrad Retailer.

## ENDURO ALUMINIUM ENGINE GUARD IN BLACK



- Available for:**
- R 1200 GS
  - R 1200 GS Adventure

This sturdy Enduro aluminium engine guard was specially constructed for off-road use and provides optimal protection for the lower section of the engine.

To be fitted and/or enabled in a specialist workshop, ideally at your authorised BMW Motorrad Retailer.

## ENGINE PROTECTION BAR



- Available for:**
- R 1200 R
  - R 1200 RS
  - R 1200 GS
  - R 1200 GS Adventure

The robust engine protection bar, made of polished stainless steel, reliably protects the right cylinder area against damage without restricting the rider's freedom to lean the machine. The robust tube construction will even take hard knocks and prevent major fall damage.

## CYLINDER HEAD COVER GUARD



- Available for:**
- R 1200 R
  - R 1200 RT
  - R 1200 RS
  - R 1200 GS
  - R 1200 GS Adventure

The stainless steel cylinder-head cover guard provides excellent protection for the cylinder head cover, preventing scratches and damage caused by flying stones. It has been perfectly matched to the vehicle, is equipped with a large rubber bumper and optimally emphasises the design and contours of the opposed-twin engine.

## SAFETY SCREW FOR OIL FILLER CAP



- Available for:**
- R 1200 R
  - R 1200 RT
  - R 1200 RS
  - R 1200 GS
  - R 1200 GS Adventure

The safety screw for the oil filler cap protects against theft and foreign substances in the oil. It also gives an individual look.

**Safety screw plug for oil filler neck, black (not shown, NEW)**

## HAND PROTECTORS



- Available for:**
- R 1200 GS

The hand protector, made of impact-resistant plastic, protects the hands against wind and weather and also from branches and stone chips when riding off-road.

Also available as an equipment option.

## PROTECTIVE GLASS FOR 6.5-INCH TFT DISPLAY



- Available for:**
- R 1200 GS
  - R 1200 GS Adventure
- Only available for model codes 0A01, 0A11

The protective glass reliably protects the 6.5-inch TFT display from dirt, flying stones and damage. The hardened glass has an anti-glare and anti-reflective surface, so that the TFT display can be read easily. With BMW Motorrad inscription.

## RADIATOR GRILLE

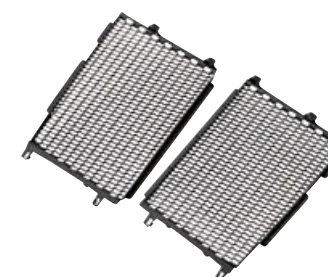

- Available for:**
- R 1200 GS
  - R 1200 GS Adventure

An absolute must-have for all off-road riders: the protective grille made of shatter-proof plastic effectively protects the radiator against damage from stone chips or bushes when riding off-road. This useful extra feature for the left side is very easy to install and also highlights the motorcycle's robust Enduro look.

## FRAME PROTECTOR



- Available for:**
- R 1200 GS
  - R 1200 GS Adventure
- Only available for model codes 0A01, 0A11

The frame protector made of black plastic protects the frame from scratches and prevents chafe marks caused by motorcycle boots in hard off-road use. The set comprises the frame protector for the left-hand and right-hand side as well as six tensioning straps. Installation is carried out quickly in just a few steps.

## LED ADDITIONAL HEADLIGHTS



- Available for:**
- R 1200 GS
  - R 1200 GS Adventure
- Only available for model codes 0A01, 0A11

The powerful LED additional headlights deliver the necessary perspective when visibility is poor thanks to extended illumination.

To be fitted and/or enabled in a specialist workshop, ideally at your authorised BMW Motorrad Retailer. The additional headlights are approved for use as fog lights, and may only be used in poor weather conditions. Country-specific road traffic regulations apply.

## LED ADDITIONAL HEADLIGHTS FOR R 1200 GS



- Available for:**
- R 1200 GS

The powerful LED additional headlights in a compact aluminium housing ensure better vision and visibility even in fog, rain or snowfall. At the same time, their white, daylight-like light colour ensures differentiated illumination of the road. LED technology ensures virtually wear-free operation.

## HEADLIGHT GUARD



- Available for:**
- R 1200 GS
  - R 1200 GS Adventure
- Only available for model codes 0A01, 0A11

The headlight guard protects the headlight against stone chip damage when riding on terrain other than public roads.

To be fitted and/or enabled in a specialist workshop, ideally at your authorised BMW Motorrad Retailer.



## 370 R MODEL RANGE, WATER-COOLED: PREVIOUS MODELS SAFETY / MAINTENANCE & TECHNOLOGY

### SPLASH AND FLYING STONE PROTECTION ACCESSORY SET

**Available for:**

- R 1200 GS
- Only available for model codes 0A51, 0A61

The accessory set comprises a radiator protector and protective covers for the frame. The robust protective grilles made of impact-resistant plastic protect the radiator from damage caused by stone chips or bushes, especially off-road, while the protective covers protect the rear frame area from damage and provides splash protection when riding through rain or mud.



### ANTI-THEFT ALARM SYSTEM RETROFIT SET (NOT SHOWN)

**Available for:**

- R 1200 R
- R 1200 RT
- R 1200 RS
- R 1200 GS
- R 1200 GS Adventure

Only available for model codes 0A01, 0A11

Strong protection from theft: If the motorcycle is moved or struck violently, the anti-theft alarm system responds with a clearly audible signal and a flashing warning light. The acoustic and optical warning will draw the attention of passers-by quickly. The alarm system is activated automatically when the ignition is switched off.

Note the differences in national-market versions. To be fitted and/or enabled in a specialist workshop, ideally at your authorised BMW Motorrad Retailer.

### ACTIVATION CODE FOR DTC (NOT SHOWN)

**Available for:**

- R 1200 R
- R 1200 RT
- R 1200 RS
- R 1200 GS
- R 1200 GS Adventure

Dynamic Traction Control (DTC) ensures greater riding stability and controls wheel slip even when leaning into corners to prevent the rear wheel from spinning. Depending on the riding mode, DTC allows more or less slip and thus guarantees the maximum safety and riding dynamics on different routes.

To be fitted and/or enabled in a specialist workshop, ideally at your authorised BMW Motorrad Retailer.

### ABS PRO RETROFIT SET (NOT SHOWN)

**Available for:**

- R 1200 R
- R 1200 RS
- R 1200 GS
- R 1200 GS Adventure

The BMW Motorrad ABS Pro is available in all riding modes and also adapts the ABS control to the motorcycle's lean angle. The system is perfectly adapted to the selected riding mode and ensures optimum braking performance even in bends. The motorcycle does not right itself and remains on course.

To be fitted and/or enabled in a specialist workshop, ideally at your authorised BMW Motorrad Retailer.

### TYRE PRESSURE CONTROL RETROFIT SET (NOT SHOWN)

**Available for:**

- R 1200 R
- R 1200 RT
- R 1200 RS
- R 1200 GS
- R 1200 GS Adventure

Now with gradient monitoring, TPC from BMW Motorrad constantly monitors tyre pressure and provides riders with real-time updates. Riders are also alerted when there is any significant drop in pressure. Also available as optional equipment.

To be fitted and/or enabled in a specialist workshop, ideally at your authorised BMW Motorrad Retailer.

### DAYTIME RUNNING LIGHT RETROFIT SET (NOT SHOWN)

**Available for:**

- R 1200 R
- R 1200 RT
- R 1200 RS
- R 1200 GS
- R 1200 GS Adventure

To be fitted and/or enabled in a specialist workshop, ideally at your authorised BMW Motorrad Retailer.

### ASC (AUTOMATIC STABILITY CONTROL) RETROFIT SET, SWITCHABLE (NOT SHOWN)

**Available for:**

- R 1200 R
- R 1200 RT
- R 1200 RS
- R 1200 GS
- R 1200 GS Adventure

To be fitted and/or enabled in a specialist workshop, ideally at your authorised BMW Motorrad Retailer.

# MAINTENANCE & TECHNOLOGY

### POWER SOCKET

**Available for:**

- R 1200 R
- R 1200 RT
- R 1200 RS
- R 1200 GS
- R 1200 GS Adventure

Electronic devices can be connected to the vehicle electrical system via the 12V power socket. One example of this is the BMW USB charger, which can be used to charge and operate mobile phones and MP3 players with an appropriate interface while riding.

To be fitted and/or enabled in a specialist workshop, ideally at your authorised BMW Motorrad Retailer.

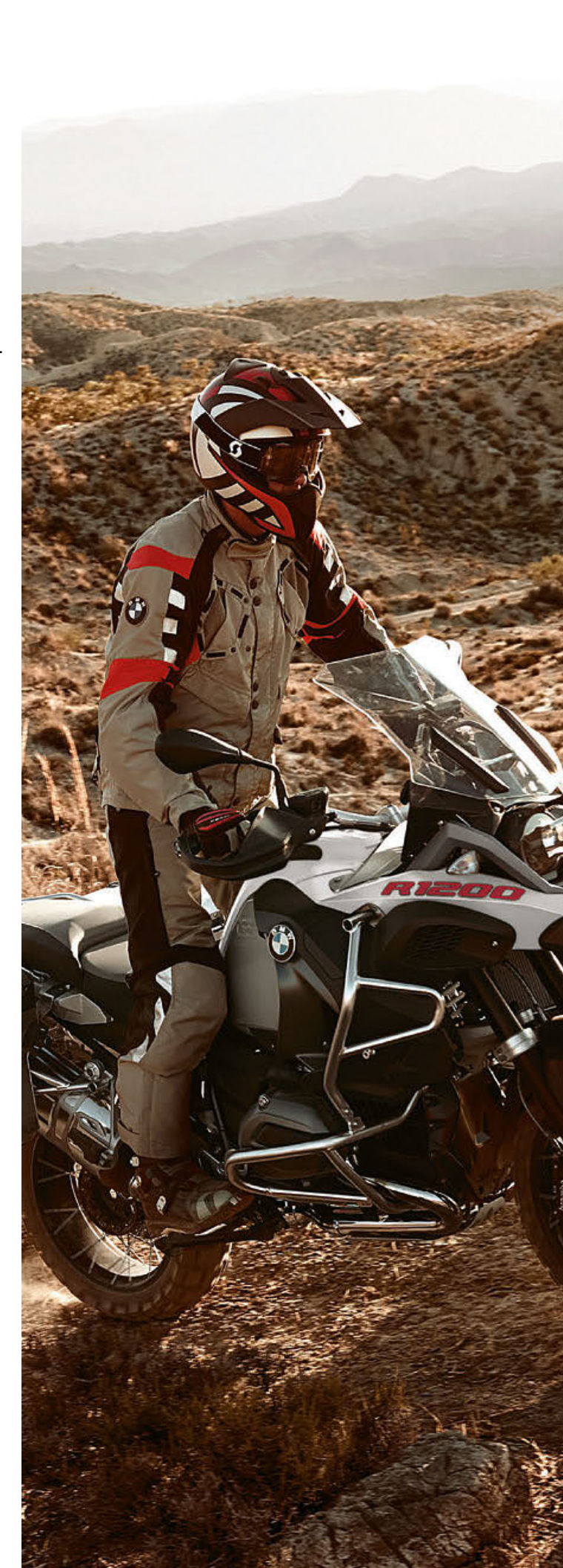

Original BMW Motorrad equipment is available from your authorised BMW Motorrad Retailer.



# R MODEL RANGE

## AIR-COOLED

HP PARTS	374	NAVIGATION & COMMUNICATION	395
STORAGE	377	SAFETY	396
DESIGN	386	MAINTENANCE & TECHNOLOGY	399
ERGONOMICS & COMFORT	390		

#### Vehicle-specific accessories for:

- R 1200 R  
Model code 0378, 0398, 0400, 0490
- R 1200 RT  
Model code 0368, 0388, 0430, 0440
- R 1200 S  
Model code 0366, 0396
- R 1200 ST  
Model code 0328, 0338
- R 1200 GS  
Model code 0307, 0317, 0303, 0313, 0450, 0460
- R 1200 GS Adventure  
Model code 0382, 0397, 0380, 0390, 0470, 0480





# HP PARTS

## HP SPORT SILENCER

**1 Available for:**

- R 1200 R
- Only available for model codes 0400, 0490

**2 Available for:**

- R 1200 RT
- R 1200 ST

**3 Available for:**

- R 1200 S

**4 Available for:**

- R 1200 GS
- R 1200 GS Adventure

Only available for model codes 0450, 0460, 0470, 0480

**Sport rear silencer (not shown) available for:**

- R 1200 R
- Only available for model codes 0378, 0398

**Sport rear silencer (not shown) available for:**

- R 1200 GS
- R 1200 GS Adventure

Not available for model codes 0450, 0460, 0470, 0480

Made entirely out of titanium, this slip-on silencer delivers a powerful rumble. It's also remarkably lightweight.

1 HP sports silencer



2 HP sports silencer



3 HP sports silencer



4 HP sports silencer



## HP CARBON CYLINDER HEAD COVERS

**Available for:**

- R 1200 R
- R 1200 RT
- R 1200 S
- R 1200 ST
- R 1200 GS
- R 1200 GS Adventure

Not available for model codes 0430, 0440, 0450, 0460, 0470, 0480

The HP carbon cylinder head covers score big in the looks department, thanks to a high-quality material and finish, and it also helps reduce the overall weight of the bike.

Not available in conjunction with aluminium/plastic cylinder head cover guard. To be fitted and/or enabled in a specialist workshop, ideally at your authorised BMW Motorrad Retailer.



## HP MILLED HAND LEVER

**Available for:**

- R 1200 R
- R 1200 RT
- R 1200 RS
- R 1200 GS
- R 1200 GS Adventure

The ergonomically optimised HP milled hand lever is made from colourless anodised aluminium and impressively emphasises the motorbike's sportiness. It is milled from a high-strength aluminium alloy that is completely resistant to corrosion and integrates perfectly into the bike's sporty design in terms of the colour.

To be fitted and/or enabled in a specialist workshop, ideally at your authorised BMW Motorrad Retailer.



## HP CARBON BELT COVER

**Available for:**

- R 1200 RT
- R 1200 S
- R 1200 ST
- R 1200 GS
- R 1200 GS Adventure

The high-quality HP carbon belt cover gives the front of the engine an elegant look with a discreet high-tech appeal. The exclusive CFRP cover is sealed with a UV-resistant high-gloss coating and features the BMW emblem at its centre.

To be fitted and/or enabled in a specialist workshop, ideally at your authorised BMW Motorrad Retailer.



## HP FORGED WHEELS

**Available for:**

- R 1200 R
- R 1200 S

Thanks to the use of lightweight-construction techniques, the HP forged wheels are approx. 1.1 kg lighter (per set) than the standard wheels. Reducing the unsprung and rotating mass improves handling and the quality of the suspension.

To be fitted and/or enabled in a specialist workshop, ideally at your authorised BMW Motorrad Retailer.





**HP INSTRUMENT CLUSTER**

**Available for:**  
• R 1200 S

The all-weather HP instrument cluster combines the classic BMW display with a host of racetrack-inspired features – a dream addition for all motorsport enthusiasts.

To be fitted and/or enabled in a specialist workshop, ideally at your authorised BMW Motorrad Retailer.



**HP CARBON HEAT PROTECTION COVER (NOT SHOWN)**

**Available for:**  
• R 1200 GS  
• R 1200 GS Adventure  
Only available for model codes 0450, 0460, 0470, 0480

The HP carbon heat protection cover for the join between the silencer and the exhaust-manifold replaces the standard aluminium trim and is suitable for both the standard and HP sports silencers.

**HP LABEL**

**Available for:**  
• R 1200 R  
• R 1200 RT  
• R 1200 S  
• R 1200 ST  
• R 1200 GS

With the self-adhesive HP label, the HP carbon parts can be further customised on request. The silver-coloured inscription on a black background measures 22x9 mm.

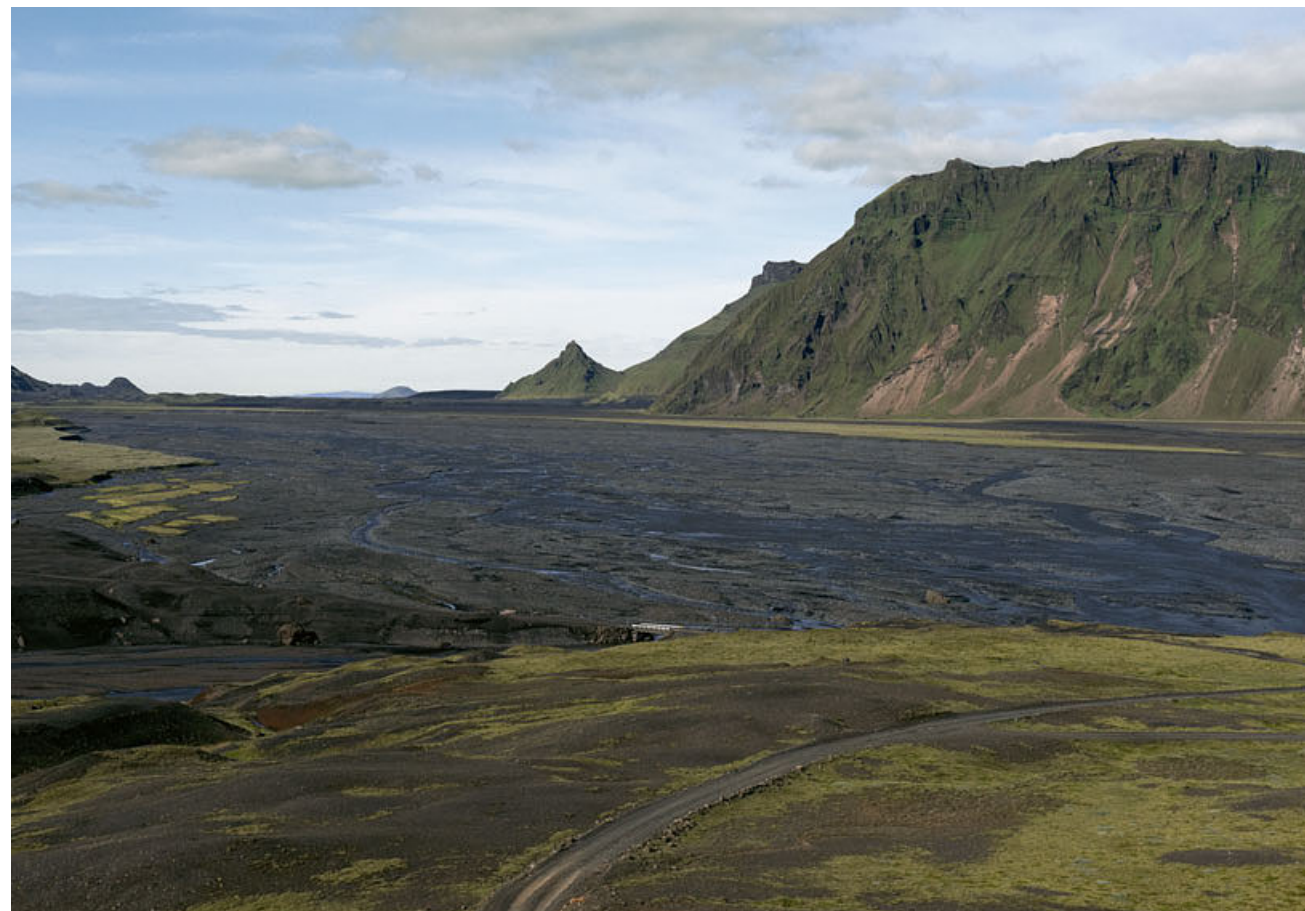

**STORAGE**

**ALUMINIUM CASES**

**Available for:**  
• R 1200 GS Adventure

The perfect solution for touring fans who place the highest demands on themselves and their equipment: the aluminium case for mounting on the left-hand side offers 44 litres of storage space. The aluminium case for mounting on the right-hand side offers 36 litres of storage space. This robust piece of transport equipment is dust- and waterproof. Many practical details impress even under extreme conditions.

Not available in conjunction with LED indicators at the rear with short base TNR 8 522 499; install LED indicators with long base TNR 8 522 500 if necessary. For information on speed and load restrictions, please refer to the instruction booklet.



**LUGGAGE COMPARTMENT SEPARATING NET FOR ALUMINIUM CASES**

**Available for:**  
• R 1200 GS Adventure

The luggage net for aluminium cases and topcases creates more order and makes it easier to access frequently used items. The highly flexible net is attached to the inside of the lid and ensures that luggage such as raincoats, folding backpacks, toiletry bags and sneakers are always at hand when the case is opened.



**ALUMINIUM TOPCASE**

**Available for:**  
• R 1200 GS Adventure

The waterproof topcase has a capacity of 32 litres and lashing eyes for securing additional luggage. And with the optional backrest pad added, it provides increased comfort for the passenger.

For information on speed and load limitations, please refer to the instruction booklet.





**TOPCASE CARRIER FOR ALUMINIUM TOPCASE**

**Available for:**  
• R 1200 GS Adventure



**BACKREST PAD FOR ALUMINIUM TOPCASE**

**Available for:**  
• R 1200 GS Adventure

For information on speed and load restrictions, please refer to the instruction booklet.



**LINER FOR ALUMINIUM CASES AND ALUMINIUM TOPCASE**

**Available for:**  
• R 1200 GS  
• R 1200 GS Adventure  
Not available for model codes 0307, 0317, 0303, 0313

High-quality materials and a robust design make the watertight liner suitable for use both in and on top of aluminium cases and topcases.



**CARRY HANDLE FOR ALUMINIUM CASE / TOPCASE**

**Available for:**  
• R 1200 GS Adventure

Convenient and functional: The practical carry handles for aluminium cases and topcases make it easy to transport the luggage to and from the bike. If the cases are mounted, additional luggage can also be attached to the handles.



**VARIABLE CASES**

**Available for:**  
• R 1200 GS

The variable cases are fitted with a patented adjustment system, allowing the capacity to be reduced from 68l (29l left, 39l right) per case by 9l to 50l (20l left, 30l right). The case is 120mm narrower when capacity is reduced, which is useful in city traffic.



**CASE HOLDERS FOR VARIABLE CASES**

**Available for:**  
• R 1200 GS

The case holder (for mounting variable cases) fits effortlessly into the overall design of the bike. Thanks to its high-quality Silver paint finish, it also won't look out of place when no cases are mounted.



**VARIABLE TOPCASE**

**Available for:**  
• R 1200 GS

Like the cases, the topcase is fitted with a patented adjustment system, which increases capacity from 25l to 35l. The variable topcase can also be mounted in the place of the passenger seat (for improved weight distribution, closer to the centre of gravity). In this case, the luggage plate must also be removed, and a mounting kit is required for the topcase.



**BACKREST PAD FOR VARIABLE TOPCASE**

**Available for:**  
• R 1200 GS





**MOUNTING FOR TOPCASE INSTEAD OF PASSENGER SEAT AND TOPCASE CARRIER**

- Available for:**
- R 1200 GS

**LINER FOR VARIABLE CASE AND VARIABLE TOPCASE**

- Available for:**
- R 1200 GS

The practical, waterproof liner with removable carry strap keeps its contents well protected. As with the variable case, its capacity is adjustable.

**1 Liner for variable case, left**

**2 Liner for variable case, right and variable topcase**



**ATACAMA LUGGAGE SYSTEM**

**1 - 2 Available for:**

- R 1200 R
- R 1200 RT
- R 1200 GS
- R 1200 GS Adventure

The Atacama luggage roll made of a robust mix of materials convinces with clever details and a storage volume of 40 litres. In addition to the waterproof liner, various storage compartments provide additional space. The versatile fastening concept, three carry handles and backpack function ensure a secure hold and extremely practical handling.

**3 - 4 Available for:**

- R 1200 GS Adventure

The Atacama side bags convince with clever details and a combined storage volume of 60 litres. In addition to the waterproof liners, various storage compartments provide additional space. Quick-release fasteners for easy mounting on the motorcycle and sturdy carry handles ensure a secure hold and extremely practical handling.

The Atacama side bags and roll bag and other pieces of luggage or helmets can be secured to the motorcycle using the lockable tension straps with steel core.

**1**

For information on speed and load limitations, please refer to the instruction booklet.

**2**

Only available in conjunction with case holder for aluminium cases.

For information on speed and load restrictions, please refer to the instruction booklet.

**1 Atacama luggage roll, 40 l**

**2 Tensioning strap for Atacama roll bag, lockable**



**3 Atacama side bags, 25 l and 35 l**

**4 Tensioning straps for Atacama side bags, lockable**





**SYSTEM CASES**

- Available for:**
- R 1200 R
  - R 1200 ST

The sleek design of the watertight system cases blends in effortlessly with the overall profile of the bike. Each case has a capacity of approx. 32l.



**CASE HOLDERS FOR SYSTEM CASES**

- Available for:**
- R 1200 R



**LINER FOR SYSTEM CASES**

- Available for:**
- R 1200 R
  - R 1200 RT
  - R 1200 ST

These liners are a perfect fit, both sturdy and lightweight. Handy compartments for small items and carry handles that can be tucked away make them essential travel companions.

Liner for left and right side identical.



**LINER FOR LARGE TOPCASE, 49 L**

- Available for:**
- R 1200 RT



**SMALL WATERPROOF TOPCASE, 28 L**

- Available for:**
- R 1200 R
  - R 1200 RT
  - R 1200 ST

With a volume of 28 litres, the waterproof topcase offers enough space for a helmet and impresses in daily use and on short tours. It is made of a hard-wearing plastic mix in a double-shell design. Its weight is approx. 5.5 kilograms. Backrest pad also available.



**LINER FOR SMALL TOPCASE, 28 L**

- Available for:**
- R 1200 R
  - R 1200 RT
  - R 1200 ST

The matching liner for the small topcase gets the luggage organised and facilitates loading and unloading. The carry handle and shoulder strap make the bag easy to access and transport. Practical details include the three-sided all-round zipper.



**IMPACT PROTECTION FOR SYSTEM CASES**

- Available for:**
- R 1200 R
  - R 1200 RT
  - R 1200 ST

Protects lower area of cases against scratching.



**PROTECTIVE FILM FOR SYSTEM CASES**

- Available for:**
- R 1200 RT

The self-adhesive protective film, protects case paintwork, e.g. from boot marks.



**LARGE TOPCASE**

- Available for:**
- R 1200 RT

At 49 litres, the waterproof topcase has a painted lid and offers plenty of space, for example for two helmets. The optional backrest pad offers additional comfort for the passenger. Available in Sapphire black and White aluminium (only available for model codes 0368, 0388).



**BACKREST PAD FOR SMALL TOPCASE**

- Available for:**
- R 1200 R
  - R 1200 RT
  - R 1200 ST



**LARGE CASE HOLDER INCL. LUGGAGE CARRIER**

- Available for:**
- R 1200 R
  - R 1200 RT
  - R 1200 ST



**LUGGAGE CARRIER**

- Available for:**
- R 1200 R

The sturdy, stylish luggage carrier is ideal for reliably securing the topcase or other large items of luggage. In addition, it serves as a convenient handle for the passenger and is also ideal for using as a pushing aid when manoeuvring.

To be fitted and/or enabled in a specialist workshop, ideally at your authorised BMW Motorrad Retailer.





## 384 R MODEL RANGE, AIR-COOLED: PREVIOUS MODELS STORAGE

### LARGE TANK BAG

**Available for:**

- R 1200 GS
- Not available for model codes 0307, 0317

The large tank bag with waterproof main compartment also comes with a detachable hip bag with length-adjustable carry strap. The A4 map pocket has a preformed shelf insert for mobile phones and other small items.

Not available in conjunction with handlebar cross-brace.



### TANK BAG

**Available for:**

- R 1200 RT

The tank bag with waterproof main compartment and A4 map pocket attaches quickly and easily to the motorcycle via "easy-click-on" technology with locking latch. An all-round zip increases capacity from 13l to 20l.

Cannot be used when BMW Motorrad Navigator is fitted.



### TANK BAG

**Available for:**

- R 1200 GS
  - R 1200 GS Adventure
- Not available for model codes 0303, 0313, 0450, 0460

The tank bag with a large waterproof main compartment (capacity approx. 22l), A4 map pocket and a detachable hip bag.



### TANK BAG

**Available for:**

- R 1200 ST

This tank bag has a large waterproof main compartment (approx. 12l) and a pocket (with window) for smaller items. It fits various BMW Motorrad models and can be combined with BMW Motorrad Navigator systems.



### TANK BAG

**Available for:**

- R 1200 R

Along with a waterproof main compartment and A4 map pocket, this tank bag has a zipped compartment for small items in the lid and a patch pocket for keys, glasses case, etc. An all-round zip increases capacity from approx. 13l to approx. 21l.



### SMALL TANK BAG

**Available for:**

- R 1200 GS
- Not available for model codes 0307, 0317

The small tank bag made of PVC-coated polyester fabric with belt attachment is the ideal companion for short trips. The waterproof main compartment with liner offers intelligent details such as the cable duct and fastening loops for the waterproof A4 map pocket and has a volume of 8 litres.



### UNIVERSAL TANK BAG

**Available for:**

- R 1200 R

The tank bag with a waterproof main compartment and a small map pocket fits various BMW Motorrad models. Capacity expands from approx. 10 to approx. 12l. Can be combined with BMW Motorrad Navigator systems.

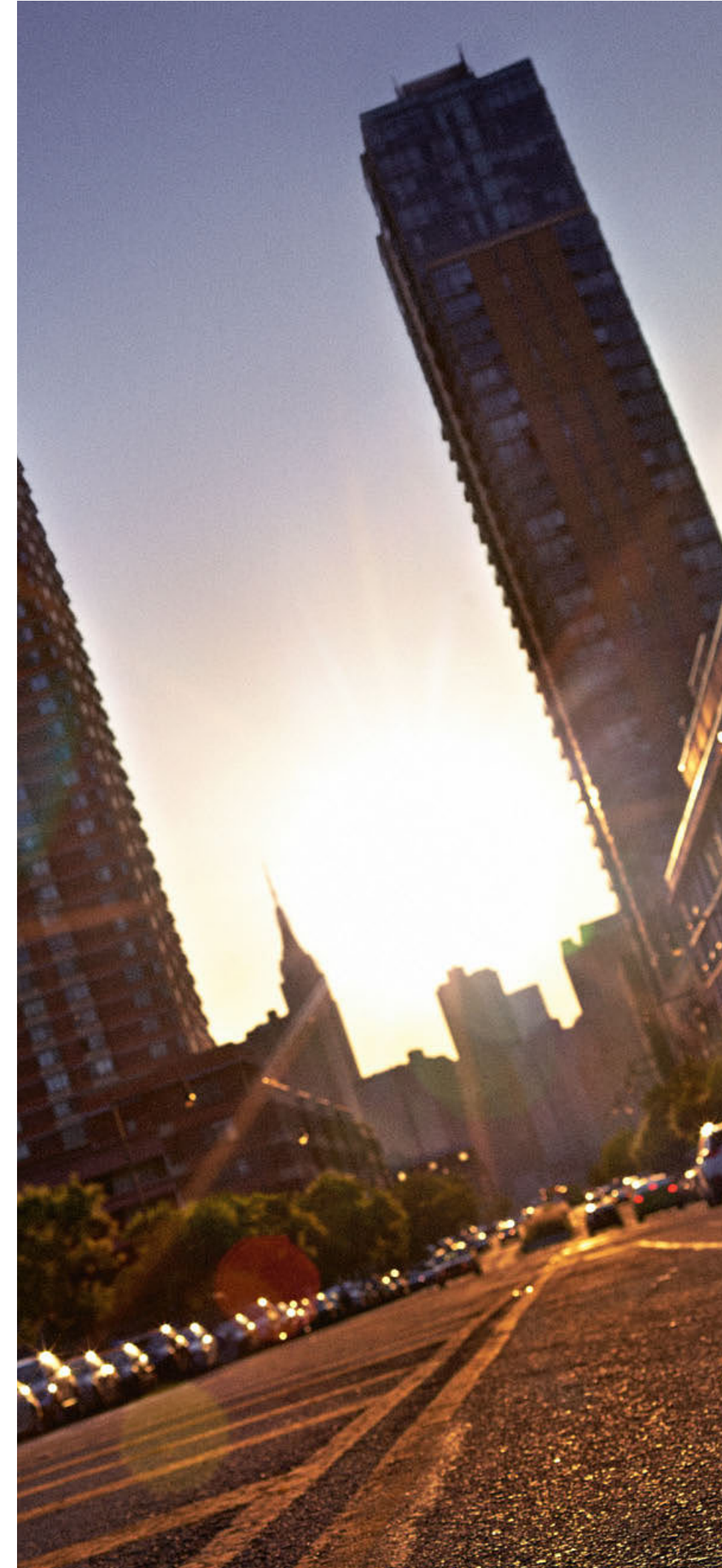



# DESIGN

## BMW MOTORRAD MACHINED PARTS

### 1 - 2 Available for:

- R 1200 R
- R 1200 GS
- R 1200 GS Adventure

Only available for model codes 0400, 0490, 0450, 0460, 0470, 0480

### 3 - 4 Available for:

- R 1200 R
- R 1200 GS
- R 1200 GS Adventure

The designs are the result of close collaboration with Roland Sands, the Californian designer, trendsetter and customization expert. All BMW Motorrad Machined Parts also feature the "by Roland Sands Design" inscription. The high-quality surfaces of these aluminium parts boast bold contrasts in Glossy Black and are produced in a series of complex processing steps, some of which are performed manually. All BMW Motorrad Machined Parts can be combined with the full range of Original BMW Motorcycle Equipment, allowing you to transform your motorcycle into your own ultra-personalised ride.

### 1 Machined cylinder head covers



### 2 Machined oil filler cap



### 3 Machined swinging-arm pivot mount cover



### 4 Machined angular transmission mount cover



## COVER CAP FOR TELELEVER AND SWINGING-ARM PIVOT MOUNT

### Available for:

- R 1200 R
- R 1200 RT
- R 1200 S
- R 1200 ST
- R 1200 GS
- R 1200 GS Adventure

Not available for model codes 0400, 0490, 0382, 0397

Turned aluminium caps are a stylish, high-quality alternative to the partially plastic standard caps on the fork bridge and Telelever.



## TELELEVER JOINT COVER CAP

### Available for:

- R 1200 R

Not available for model codes 0400, 0490

This chrome cover for the R 1200 R is the ideal complement to the fork bridge and Telelever caps.



## COVERS FOR FORK BRIDGE

### Available for:

- R 1200 R
- R 1200 GS
- R 1200 GS Adventure

Only available for model codes 0378, 0398, 0303, 0313, 0380, 0390

Turned aluminium caps are a stylish, high-quality alternative to the partially plastic standard caps on the fork bridge and Telelever.



## CHROME PARTS

### 1 Available for:

- R 1200 R
- R 1200 RT
- R 1200 GS
- R 1200 GS Adventure

Only available for model codes 0400, 0490, 0430, 0440, 0450, 0460, 0470, 0480

### 2 Available for:

- R 1200 RT

Only available for model codes 0430, 0440

### 3 Available for:

- R 1200 R

Chrome-plated parts are an eye-catching addition to your bike. The chrome-plated parts are respectively identical in form to the standard parts.

### 1

To be fitted and/or enabled in a specialist workshop, ideally at your authorised BMW Motorrad Retailer.

### 1 Cylinder head cover, chrome-plated



### 2 Expansion tank cap, chrome-plated



### 3 Custom mirrors, chrome-plated





**SILVER CYLINDER HEAD COVERS**

**Available for:**

- R 1200 R
- R 1200 RT

Only available for model codes 0400, 0490, 0430, 0440

The silver cylinder head covers give the opposed-twin engine an attractive appearance and the motorcycle an individual, high-quality look. The shape matches that of the standard covers in Granite grey.



**EXTENDED FRONT MUDGUARD**

**Available for:**

- R 1200 GS
- R 1200 GS Adventure

Not available for model codes 0307, 0317, 0382, 0397

A renowned hallmark of the GS Adventure, the extended front mudguard underlines the off-road look and helps prevent scratching.

Not available in conjunction with LED additional headlights.



**SILVER SPOKED WHEEL**

**Available for:**

- R 1200 R

Only available for model codes 0400, 0490

High-quality cross-spoke wheels are a stylish way to personalize your bike.



**LED INDICATORS**

**Available for:**

- R 1200 R
- R 1200 GS
- R 1200 GS Adventure

**LED turn indicator, rear (not shown) available for:**

- R 1200 GS
- R 1200 GS Adventure

A shining example: The beautifully designed LED indicators with white turn indicator glass convince with their slim design and modern lighting technology. They respond much faster than incandescent lamps and are virtually wear-free. This provides a clear safety advantage in road traffic. The set includes two LED indicators for retrofitting.

Note the differences in national-market versions. To be fitted and/or enabled in a specialist workshop, ideally at your authorised BMW Motorrad Retailer.



**LED REAR LIGHT**

**1 Available for:**

- R 1200 R

Sleek rear lights with state-of-the-art LED technology fuse style with technical wizardry. Practically wear-free, they increase safety in road traffic.

**2 Available for:**

- R 1200 GS
- R 1200 GS Adventure

Only available for model codes 0307, 0317, 0382, 0397

Note the differences in national-market versions. To be fitted and/or enabled in a specialist workshop, ideally at your authorised BMW Motorrad Retailer.

**1 LED rear light**



**2 LED rear light**



**GS DECOR STICKER SET**

**1 Available for:**

- R 1200 GS (from 2008 construction year)

The sticker set in Racing Red and Racing Blue Metallic is perfectly tailored to your vehicle. These highly durable stickers really stand out thanks to their vivid and metallic colour effects. The pack comes with instructions and application aids so they can be easily applied without creating air bubbles.

**2 Available for:**

- R 1200 GS Adventure (from 2008 construction year)

**Set contents:**

- Sticker set for: Mudguard, fuel tank, case, topcase, aluminium rims (K25), spoked rims (K25 Adventure), rim base décor
- Accessories (smoothing blade, application fluid, cleaning cloth)
- Application instructions

**1 GS decorative sticker set**



**2 GS Adventure decorative sticker set**





# ERGONOMICS & COMFORT

## HIGH WINDSCREEN

**Available for:**  
• R 1200 R

The high windscreen makes the R 1200 R even more of a touring machine, coming into its own on long stretches of motorways.



## SPORT WINDSCREEN

**Available for:**  
• R 1200 R

Offering the wind protection of a far larger screen, the sport windscreen variants deflect wind away from the rider, providing noticeable relief. It also enhances the classic roadster look of the R 1200 R.

1 Sport windscreen, tinted



2 Sport windscreen, clear



## TINTED WINDSCREEN

**1 Available for:**  
• R 1200 GS

The tinted windscreen gives the bike a sportier look. Same design and size as the standard windscreen.

**2 Available for:**  
• R 1200 GS Adventure

Note the differences in national-market versions.  
To be fitted and/or enabled in a specialist workshop, ideally at your authorised BMW Motorrad Retailer.

1 Tinted windscreen



2 Tinted windscreen





SEATS

**1 Available for:**

- R 1200 R
- Not available for model codes 0400, 0490

**High comfort seat & low seat, black & sport seat (not shown) available for:**

- R 1200 R

**Low seat, grey & low seat, black**

**(not shown) available for:**

- R 1200 RT

**2 & 4 available for:**

- R 1200 RT

**3 & 5 Available for:**

- R 1200 R

1 Comfort seat



2 Comfort seat



3 Extra low seat, black



4 Extra low seat, black



5 High seat, black



**LOW RIDER SEAT, BLACK (NOT SHOWN)**

**Available for:**

- R 1200 ST

RIDER SEAT/PASSENGER SEATS

**1 Available for:**

- R 1200 GS
  - R 1200 GS Adventure
- Not available for model codes 0382, 0397, 0470, 0480

**3 Available for:**

- R 1200 GS
  - R 1200 GS Adventure
- Not available for model codes 0303, 0313, 0470, 0480

**7 Available for:**

- R 1200 GS
  - R 1200 GS Adventure
- Not available for model codes 0303, 0313, 0382, 0397, 0470, 0480

**2 & 5 Available for:**

- R 1200 GS

**4 & 6 Available for:**

- R 1200 GS
- R 1200 GS Adventure

**Rider seat, grey & passenger seat, grey (not shown) available for:**

- R 1200 GS
- Not available for model codes 0303, 0313

1 Low rider seat, black



2 Rider seat, black



3 Rider seat, black/aluminium



4 Rider seat, black/red



5 Passenger seat, black



6 Passenger seat, black/aluminium



7 Passenger seat, black/red

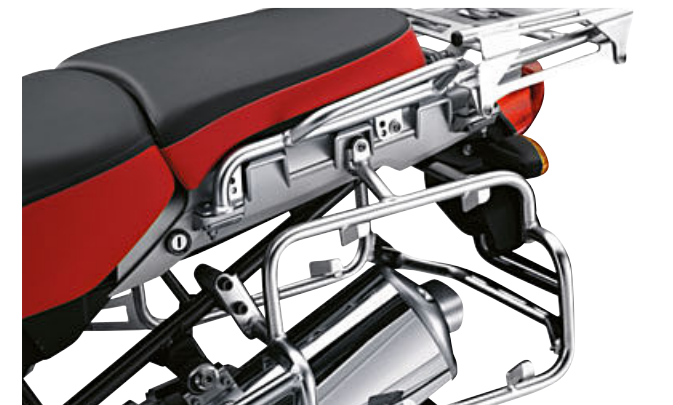



**HEATED GRIPS**

**1 Available for:**

- R 1200 R
- R 1200 S
- R 1200 GS
- R 1200 GS Adventure

Not available for model codes 0307, 0317, 0382, 0397

**2 Available for:**

- R 1200 RT

Not available for model codes 0430, 0440

**3 Available for:**

- R 1200 R
- R 1200 S

Not available for model codes 0400, 0490

**4 Available for:**

- R 1200 ST
- R 1200 GS
- R 1200 GS Adventure

Only available for model codes 0307, 0317, 0382, 0397

Keep your hands as warm as you like with retrofittable heated grips.

**2**

To be fitted and/or enabled in a specialist workshop, ideally at your authorised BMW Motorrad Retailer.

**1 Heated grip**



**2 Heated grip**



**3 Heated grip**



**4 Heated grip**



**WIDE ENDURO FOOTREST**

**Available for:**

- R 1200 ST
- R 1200 GS
- R 1200 GS Adventure

Not available for model codes 0307, 0317

Wide Enduro footrests provide a better foothold and improve control when riding off-road or in a standing position.



**ADJUSTABLE FOOTBRAKE LEVER (NOT SHOWN)**

**Available for:**

- R 1200 GS
- R 1200 GS Adventure

Wider than before and height-adjustable, the footbrake lever improves the control of brake pressure when riding in a standing position.

**NAVIGATION & COMMUNICATION**

**BMW MOTORRAD NAVIGATOR VI (INCL. 4-BUTTON CRADLE MOUNT)**

**Available for:**

- R 1200 R
- R 1200 RT
- R 1200 S
- R 1200 ST
- R 1200 GS
- R 1200 GS Adventure

Not only touring fans will have plenty of choice with the Navigator VI. The system makes route planning child's play and offers numerous additional functions that make every tour an exciting experience. The five inch touch screen is waterproof, easy to read even in direct sunlight and ensures that you can see the big picture required in every situation.

Note differences in national-market versions.  
 Only in combination with bracket for BMW Motorrad navigation devices.



**BMW MOTORRAD SMARTPHONE CRADLE**

**Available for:**

- R 1200 R
- R 1200 GS
- R 1200 GS Adventure

BMW Motorrad's robust smartphone cradle provides a safe and protected place for your smartphone. This means that useful functions such as navigation information and online information can also be used while you are on the move. Thanks to the handy charging function, your smartphone is also always ready for action on extended bike tours.

Only in combination with bracket for BMW Motorrad navigation devices.



**BRACKET FOR BMW MOTORRAD NAVIGATION SYSTEMS (NOT SHOWN)**

**Available for:**

- R 1200 R
- R 1200 RT
- R 1200 ST
- R 1200 GS
- R 1200 GS Adventure

Bracket for mounting BMW Motorrad navigation devices  
 Guarantees a good view of the navigation system.



# SAFETY

## HANDLEBAR CROSS-BRACE

**Available for:**

- R 1200 GS
- R 1200 GS Adventure

Not available for model codes 0307, 0317, 0382, 0397

Adds more stability to the handlebars.



## HANDLEBAR CROSS-BRACE PADDING

**Available for:**

- R 1200 GS
- R 1200 GS Adventure

Available in Black/White or Red/Black.



## LARGE UPPER SECTION OF HAND PROTECTORS

**Available for:**

- R 1200 GS
- R 1200 GS Adventure

Not available for model codes 0380, 0390

The large upper section of the hand protector adds an extra barrier against wind, rain and flying stones.



## HAND PROTECTORS

**Available for:**

- R 1200 GS
- R 1200 GS Adventure

Only available for model codes 0307, 0317, 0382, 0397

Protect the hands and instruments from wind and rain, and from low-hanging branches and flying stones on off-road trails.



## HAND PROTECTORS

**Available for:**

- R 1200 GS

Not available for model codes 0307, 0317

Protect the hands and instruments from wind and rain, and from low-hanging branches and flying stones on off-road trails.



## HEADLIGHT GUARD

**Available for:**

- R 1200 GS
- R 1200 GS Adventure

Not available for model codes 0307, 0317

Protects headlight from flying stones during off-road use. With snaplock system for quick attachment and removal.

Only for off-road use (not homologated for road use).



## ALUMINIUM ENGINE GUARD

**Available for:**

- R 1200 GS
- R 1200 GS Adventure

The robust aluminium engine guard effectively protects the lower area against stone chips and damage, for example, when bottoming out. Nothing stands in the way of an off-road excursion. Also street riders will appreciate the discreet off-road look.

To be fitted and/or enabled in a specialist workshop, ideally at your authorised BMW Motorrad Retailer.



## STAINLESS STEEL FRAME PROTECTOR

**Available for:**

- R 1200 GS
- R 1200 GS Adventure

The high-quality frame protector, made from laser-cut stainless steel, helps prevent scratching.



## STAINLESS STEEL ENGINE PROTECTION BAR

**1 Available for:**

- R 1200 R
- Only available for model codes 0400, 0490

**2 Available for:**

- R 1200 GS
- Cannot be fitted at the same time as the plastic cylinder head cover guard (71 60 7 693 843).

In situations where impacts are unavoidable, the engine protection bar helps prevent damage to the cylinder area of the engine. The R 1200 GS is designed for heavy off-road use on tricky terrain, so this is the ideal complement to the standard underride guard.

### 1 Stainless steel engine protection bar



### 2 Stainless steel engine protection bar



## CENTRE STAND

**Available for:**

- R 1200 R
- R 1200 RT
- R 1200 ST

Not available for model codes 0430, 0440

To be fitted and/or enabled in a specialist workshop, ideally at your authorised BMW Motorrad Retailer.



## SAFETY SCREW FOR OIL FILLER CAP

**Available for:**

- R 1200 R
- R 1200 RT
- R 1200 S
- R 1200 ST
- R 1200 GS
- R 1200 GS Adventure

The safety screw for the oil filler cap protects against theft and foreign substances in the oil. It also gives an individual look.

**Safety screw plug for oil filler neck, black (not shown, NEW)**





**CYLINDER HEAD COVER GUARD**

**1 & 3 Available for:**

- R 1200 R
- R 1200 RT
- R 1200 GS

Only available for model codes 0400, 0490, 0430, 0440, 0450, 0460

**2 Available for:**

- R 1200 GS
- R 1200 GS Adventure

Not available for model codes 0450, 0460, 0470, 0480

**4 Available for:**

- R 1200 R
- R 1200 RT
- R 1200 S

- R 1200 ST
- R 1200 GS

Not available for model codes 0400, 0490, 0430, 0440, 0450, 0460

Comprehensive protection for the most exposed parts of the opposed-twin engine. On tough terrain, it prevents impacts and scratches which may break the casing.

The cylinder head cover guard is made of glass-fibre-reinforced plastic and protects the cylinder head from damage.

**1 & 3**

To be fitted and/or enabled in a specialist workshop, ideally at your authorised BMW Motorrad Retailer.

**1 Aluminium cylinder-head cover plate**



**2 Aluminium cylinder-head cover plate**



**3 Plastic cylinder-head cover plate**



**4 Plastic cylinder-head cover plate**



**REAR MUDGUARD (NOT SHOWN)**

**Available for:**

- R 1200 RT

**ANTI-THEFT ALARM SYSTEM RETROFIT SET (NOT SHOWN)**

**Available for:**

- R 1200 R
- R 1200 RT
- R 1200 RS
- R 1200 GS
- R 1200 GS Adventure

If the anti-theft alarm system is moved or struck violently, the system responds with a clearly audible signal and a flashing warning light.

Note the differences in national-market versions. To be fitted and/or enabled in a specialist workshop, ideally at your authorised BMW Motorrad Retailer.

**MAINTENANCE & TECHNOLOGY**

**POWER SOCKET**

**Available for:**

- R 1200 R
- R 1200 RT
- R 1200 GS
- R 1200 GS Adventure

Electronic devices can be connected to the vehicle electrical system via the 12V power socket. One example of this is the BMW USB charger, which can be used to charge and operate mobile phones and MP3 players with an appropriate interface while riding.

To be fitted and/or enabled in a specialist workshop, ideally at your authorised BMW Motorrad Retailer.





# R MODEL RANGE R NINE T

HP PARTS	402	ERGONOMICS & COMFORT	410
STORAGE	403	NAVIGATION & COMMUNICATION	411
DESIGN	406	SAFETY	412

**Vehicle-specific accessories for:**

- R nineT  
Model codes 0A06, 0A16





# HP PARTS

## HP SPORT SILENCER

A top-class feature: made entirely of titanium, with a carbon end cap and a laser-etched HP logo. The HP sport silencer turns every ride into a thrilling experience. Choose from two positions (standard and raised) and in two colour variants (titanium and black).

**1**

Please note the specifications for different countries.  
To be fitted and/or enabled in a specialist workshop, ideally at your authorised BMW Motorrad Retailer.

**1 HP sports silencer, black**



**2 HP sports silencer**



## HP CARBON WHEEL COVERS

The HP carbon mudguard protects rider and motorbike – and emphasises the bike dynamics with the right sporty look thanks to its high-gloss finish. The high-quality carbon design also makes the cover particularly impact-resistant while reducing the overall weight of the motorbike.

To be fitted and/or enabled in a specialist workshop, ideally at your authorised BMW Motorrad Retailer.



## HP CARBON BELT COVER

The high-quality HP carbon belt cover gives the front of the engine an elegant look with a discreet high-tech appeal.

To be fitted and/or enabled in a specialist workshop, ideally at your authorised BMW Motorrad Retailer.



## HP PASSENGER FOOTRESTS, BLACK

The HP passenger footrests are milled from an anodised aluminium alloy and give the bike an even sportier appearance. Their design makes them very light, but also extremely dimensionally stable so that they provide secure support for the foot at all times.

To be fitted and/or enabled in a specialist workshop, ideally at your authorised BMW Motorrad Retailer.



# STORAGE

## TANK BAG / TANK BAG, LEATHER EDITION

Practical and stylish in one – the waterproof canvas tank bag provides 11l of storage space. Available in two material/colour combinations.

The tank strap underlines the retro look of the motorcycle and is used to attach the tank bag or small tank bag.

The leather edition tank strap in retro look with anti-slip coating is used to attach the tank bag or small tank bag.

**1&2**

For information on speed and load limitations, please refer to the instruction booklet.

**1 Tank bag, 11l**



**2 Tank bag, leather edition, 11l**



**3 Tank belt**



**4 Tank belt, leather edition**





**SMALL TANK BAG / SMALL TANK BAG, LEATHER EDITION**

Stylish and compact canvas bag for carrying a smartphone and sunglasses. Available in two material/colour combinations.

Only available in conjunction with tank belt/leather edition tank belt. For information on speed and load limitations, please refer to the instruction booklet.

1 Small tank bag, 1.5l



2 Small tank bag, leather edition, 1.5l



**REAR BAG / REAR BAG, LEATHER EDITION**

The waterproof rear bag made of black canvas has style and offers plenty of room for luggage with its 40-litre volume. Two side patch pockets, colour-contrasting straps and brushed metal buckles are a perfect match for the classic design of the Heritage models. Available in two material/colour combinations.

Not for use with luggage rack, Scrambler single seat, passenger comfort seat, side bag(s) or seat hump cover. For information on speed and load limitations, please refer to the instruction booklet.

1 Rear bag, leather edition, 40l



2 Rear bag, 40l



**SIDE BAGS / SIDE BAGS, LEATHER EDITION**

The waterproof side bags in retro style look extremely casual and with their 14-litre (right) and 9-litre (left) capacity offer plenty of storage space for luggage. Under the water-repellent outer fabric made of black canvas, the bag contents stay dry in a waterproof, removable inside pocket with a roll closure. Available in two material/colour combinations.

Not available in conjunction with the rear bag. For information on speed and load limitations, please refer to the instruction booklet.

**3**

Only available in conjunction with a low positioned silencer.

1 Left side bag, leather edition, 9l



2 Right side bag, leather edition, 14l



3 Left side bag, 9l



4 Right side bag, 14l



**BRACKET FOR SIDE BAG**

The bracket integrates inconspicuously into the bike design and allows for the side bag to be easily installed by means of a snap fastener.

1 Bracket for side bag, left



2 Bracket for side bag, right





# DESIGN

## BMW MOTORRAD MACHINED PARTS

Each unique, lovingly crafted BMW Motorrad Machined Part is designed to make the BMW R nineT even more stunning. The designs are the result of close collaboration with Roland Sands, the Californian designer, trendsetter and customization expert. All BMW Motorrad Machined Parts also feature the "by Roland Sands Design" signature logo. The high-quality surfaces of these aluminium parts boast bold contrasts in Glossy Black and are produced in a series of complex processing steps, some of which are performed manually. All BMW Motorrad Machined Parts can be combined with the full range of Original BMW Motorcycle Equipment, allowing you to transform the BMW R nineT into your own ultra-personalized ride.

To be fitted and/or enabled in a specialist workshop, ideally at your authorised BMW Motorrad Retailer.

1 Machined handlebar clamp



2 Machined headlight cover



3 Machined belt cover



4 Machined oil filler cap



5 Machined handlebar ends cover



6 Machined rear axle cover



7 Machined angular transmission mount cover



8 Machined swinging-arm pivot mount cover



9 Machined front brake fluid tank cover



10 Machined clutch fluid tank cover



11 Machined cylinder head covers



## ALUMINIUM TAIL-HUMP COVER

The aluminium tail-hump cover is fitted in place of the passenger seat, and includes a small, spray-water protected storage compartment. The high-quality backrest pad ensures enhanced rider comfort and finishes the look visually.

**Pad for tail-hump cover (not shown)**

Only for one-up.



## ALUMINIUM TANK HAND-BRUSHED, WITH GROUND-DOWN WELD SEAM

The aluminium tank is manufactured in accordance with BMW quality standards, and hand-brushed to create its distinctive surface. This makes each tank completely unique.

To be fitted and/or enabled in a specialist workshop, ideally at your authorised BMW Motorrad Retailer.



## HAND-BRUSHED ALUMINIUM TANK, WITH VISIBLE WELD SEAM

The aluminium tank is manufactured in accordance with BMW quality standards, and hand-brushed to create its distinctive surface. This makes each tank completely unique.

To be fitted and/or enabled in a specialist workshop, ideally at your authorised BMW Motorrad Retailer.



Original BMW Motorrad equipment is available from your authorised BMW Motorrad Retailer.



**KNEE PADS**

These ergonomically shaped rubber pads protect both sides of the tank from scratches. And their stylish design underscores the classic look of the BMW R nineT.



**COVER FOR MAIN FRAME SCREW CONNECTION**

The cover of the main frame screw connection is the elegant solution when the passenger frame is removed. To this end, the open main frame screw is covered with an aluminium double sleeve.



**CYLINDER HEAD COVERS**

The black or silver cylinder head covers give the opposed-twin engine an attractive appearance and the motorcycle an individual look.

**1**  
To be fitted and/or enabled in a specialist workshop, ideally at your authorised BMW Motorrad Retailer.

**3** Cylinder head cover, black



**2** Cylinder head cover, silver



**SILENCER BRACKET**

Bracket for attaching the silencer if no passenger frame is fitted.



**LED INDICATORS**

A shining example: The beautifully designed LED indicators with white turn indicator glass convince with their slim design and modern lighting technology. They respond much faster than incandescent lamps and are virtually wear-free. This provides a clear safety advantage in road traffic.

Note the differences in national-market versions.  
To be fitted and/or enabled in a specialist workshop, ideally at your authorised BMW Motorrad Retailer.





# ERGONOMICS & COMFORT

## CUSTOM RIDER'S SEAT, BLACK

The Custom rider seat in classic black with its discreet cross stitching and details in an Alcantara look sets individual accents. Its exclusive design, the high-quality seat surface, the white double decorative stitching and the embroidered BMW R nineT inscription in gold further enhance the look of the motorcycle.

Not available in conjunction with high-positioned Sports silencer (long crossover pipe).

## URBAN SEAT IN ESPRESSO BLACK

NEW

The Scrambler seat in Espresso black offers maximum seating comfort. In addition, the high-quality seat with attractive cross stitching and leather appearance gives the Heritage models an individual look.

**Urban seat in Espresso black, low:**  
seat height: 820 mm; step length: 1,830 mm

**Urban seat in Espresso black:**  
seat height: 850 mm; step length: 1,890 mm



## COMFORT REAR SEAT, BLACK

The passenger comfort seat with retaining belt is wider and with upgraded upholstery, thus offering the passenger a noticeable increase in seating comfort. The high-quality seat surface in a black leather look, the attractive decorative double stitching in white and the embroidered R nineT inscription in gold further enhance the look of the motorcycle.



## FORK BRIDGE WITH CLIP-ON HANDLEBARS

The fork bridge with fixed clip-on handlebars allows for a clearly front-wheel-oriented seating position for a Café Racer riding style.

To be fitted and/or enabled in a specialist workshop, ideally at your authorised BMW Motorrad Retailer.



## HEATED GRIPS AND MULTIFUNCTION SWITCHES (NOT SHOWN)

Keep your hands warm in cooler temperatures with heated grips (adjustable between two settings).

To be fitted and/or enabled in a specialist workshop, ideally at your authorised BMW Motorrad Retailer.

# NAVIGATION & COMMUNICATION

## BMW MOTORRAD NAVIGATOR VI

The multifunctional BMW Motorrad Navigator VI without pre-installed maps makes route planning child's play. The system with 4 GB flash memory and five-inch touch screen always gives the right directions, and the waterproof display is easy to read even in direct sunlight owing to the circular polarisation filter. The high-resolution screen provides all the essential information and ensures that you can see the big picture required in every situation. Numerous additional functions make planning and touring an exciting experience. Plan your routes can be created according to your personal preferences and enjoy driving on winding and quiet side roads. The rider can also preset route guidance to avoid certain roads, e.g. A-roads. In unknown terrain, the "round trip" option is a good choice as it reliably guides the rider at the end of the tour back to the starting point. The Bluetooth connection to

the BMW Motorrad communication system and the optional Smartphone Link app enable multimedia on the go: navigation announcements, telephone calls and music streaming as well as the retrieval of weather forecasts or traffic jam information are no problem. Navigation preparation adds further functions such as "My Motorcycle", and the multi-controller on the handlebars offers an alternative control option. The desired map material can simply be installed on the Navigator using an SD card.

Note the differences in national-market versions.  
Only available in conjunction with OE navigation preparation.  
Also available as optional equipment, option code 272



## BMW MOTORRAD SMARTPHONE CRADLE

BMW Motorrad's robust smartphone cradle provides a safe and protected place for your smartphone. This means that useful functions such as navigation information and online information can also be used while you are on the move. Thanks to the handy charging function, your smartphone is also always ready for action on extended bike tours.

Only in combination with bracket for BMW Motorrad navigation devices.





# SAFETY

## ALUMINIUM CYLINDER-HEAD COVER PLATE

The cylinder-head cover plate, made of anodised aluminium, protects the cylinder head against damage and makes the look of the motorcycle more striking.

To be fitted and/or enabled in a specialist workshop, ideally at your authorised BMW Motorrad Retailer.



## PLASTIC CYLINDER-HEAD COVER PLATE

The glass-fibre reinforced plastic cylinder-head cover plate protects the cylinder head from damage and emphasises the design of the opposed-twin engine.

To be fitted and/or enabled in a specialist workshop, ideally at your authorised BMW Motorrad Retailer.



## ANTI-THEFT ALARM SYSTEM RETROFIT SET (NOT SHOWN)

If the anti-theft alarm system is moved or struck violently, the system responds with a clearly audible signal and a hazard warning indicator lamp.

## SAFETY SCREW FOR OIL FILLER CAP

The safety screw for the oil filler cap protects against theft and foreign substances in the oil. It also gives an individual look.





# F MODEL RANGE

HP-PARTS	416	NAVIGATION & COMMUNICATION	436
STORAGE	418	SAFETY	437
DESIGN	428	MAINTENANCE & TECHNOLOGY	439
ERGONOMICS & COMFORT	430		

#### Vehicle-specific accessories for:

- F 800 S  
Model code 0216, 0226
- F 800 ST  
Model code 0234, 0244
- F 800 GT  
Model code 0B03, 0B13, 0B53, 0B63
- F 800 R  
Model code 0217, 0227, 0B04, 0B14, 0B54, 0B64
- F 650 GS  
Model code 0218, 0228
- F 700 GS  
Model code 0B01, 0B06, 0B11, 0B16
- F 800 GS  
Model code 0219, 0229, 0B02, 0B12, 0B07, 0B17
- F 800 GS Adventure  
Model code 0B05, 0B15, 0B55, 0B65





# HP PARTS

## HP MILLED HAND LEVER

**Available for:**

- F 800 R
- Not available for model codes 0217, 0227

The ergonomically optimised HP milled hand lever is made from colourless anodised aluminium and impressively emphasises the motorbike's sportiness. It is milled from a high-strength aluminium alloy that is completely resistant to corrosion and integrates perfectly into the bike's sporty design in terms of the colour.

To be fitted and/or enabled in a specialist workshop, ideally at your authorised BMW Motorrad Retailer.

1 HP milled handbrake lever



2 HP milled clutch lever



## HP SPORTS SILENCER

**1 Available for:**

- F 800 GT
  - F 800 R
- Not available for model codes 0B03, 0B13, 0217, 0227, 0B04, 0B14

**2 Available for:**

- F 650 GS
  - F 700 GS
  - F 800 GS
  - F800 GS Adventure
- Not available for model codes 0B06, 0B16, 0B07, 0B17

**HP sports silencer (not shown) available for:**

- F 700 GS
  - F 800 GS
- Not available for model codes 0B01, 0B11, 0219, 0229, 0B02, 0B12

The sleek, high-quality slip-on silencer with titanium sleeve and carbon end cap delivers a powerful rumble. Approx. 1.8 kg lighter than standard silencer.

1 HP sports silencer



2 HP sports silencer





# STORAGE

## ALUMINIUM CASES

- Available for:**
- F 800 GS
  - F 800 GS Adventure

Suitable for off-road use, these sturdy aluminium cases have a generous capacity of approx. 82l (38l left, 44l right).



## ALUMINIUM TOPCASE AND BACKREST PAD

- Available for:**
- F 650 GS
  - F 800 GS Adventure
- Not available for model codes 0218, 0228

The waterproof topcase has a capacity of 32 litres and lashing eyes for securing additional luggage. And with the optional backrest pad added, it provides increased comfort for the passenger.

For information on speed and load limitations, please refer to the instruction booklet.

1 Aluminium topcase



2 Backrest pad for aluminium topcase



## CASE HOLDER FOR ALUMINIUM CASES AND TOPCASE CARRIER FOR ALUMINIUM TOPCASES

- Available for:**
- F 800 GS
  - F 800 GS Adventure

The aluminium case can be easily and securely attached to the sturdy case holder made of polished stainless steel.

1 Case holder for aluminium cases



2 Topcase carrier for aluminium topcase



## LINER FOR ALUMINIUM CASES AND TOPCASE

- Available for:**
- F 800 GS
  - F 800 GS Adventure

High-quality materials and a robust design make the watertight liner suitable for use both in and on top of aluminium cases and topcases.

1 Liner for aluminium cases



2 Liner for aluminium topcase





**LUGGAGE COMPARTMENT SEPARATING NET FOR ALUMINIUM CASES**

**Available for:**

- F 800 GS
- F 800 GS Adventure

The luggage net for aluminium cases and topcases creates more order and makes it easier to access frequently used items. The highly flexible net is attached to the inside of the lid and ensures that luggage such as raincoats, folding backpacks, toiletry bags and sneakers are always at hand when the case is opened.



**CARRY HANDLE FOR ALUMINIUM CASE / TOPCASE**

**Available for:**

- F 800 GS
- F 800 GS Adventure

The practical carry handles for aluminium cases and topcases make it easy to transport the luggage to and from the bike.



**SPORT CASES**

**Available for:**

- F 800 S
- F 800 ST

Splash-proof sport cases come with waterproof liners (one per case). Capacity is adjustable from 15 to 25l on each side – ample room for a helmet in each case.



**TOURING CASES**

**Available for:**

- F 800 GT
- F 800 R

Not available for model codes 0217, 0227

The splash-proof, hard-shell plastic cases have a total capacity of approx. 55l (28l left, 27l right).



**CASE HOLDER**

**1 Available for:**

- F 800 ST
- F 800 GT
- F 800 R

Only available in conjunction with luggage grid.

**2 Available for:**

- F 800 S
- F 800 ST

**1 Case holder**



**2 Case holder**





**LINER FOR TOURING CASES**

**Available for:**

- F 800 GT
- F 800 R

Not available for model codes 0217, 0227

The rigid liners are waterproof thanks to a sealed liner and drawstring closure for the main compartment. A carry handle and detachable strap make them essential travel companions.



**VARIABLE CASES**

**Available for:**

- F 650 GS
- F 700 GS
- F 800 GS

The variable cases are fitted with a patented adjustment system, allowing the capacity to be reduced from a total of 67l (29l left, 38l right) per case by 10l to 47l (19l left, 28l right). The case is narrower when capacity is reduced, which is useful in city traffic.



**CASE HOLDERS FOR VARIABLE CASES AND TOPCASE CARRIERS FOR VARIABLE TOPCASE**

**1 Available for:**

- F 650 GS
- F 700 GS
- F 800 GS

**2 Available for:**

- F 700 GS
- F 800 GS

Not available for model codes 0219, 0229, 0B07, 0B17

**1 Case holders for variable cases**



**2 Topcase carrier for variable topcase**



**ALUMINIUM TOPCASE AND BACKREST PAD**

**1 Available for:**

- F 700 GS
- F 800 GS

Not available for model codes 0219, 0229

Like the cases, the topcase is fitted with a patented adjustment system, which increases capacity from 25l to 35l.

Only available in conjunction with luggage grid.

**2 Available for:**

- F 650 GS
- F 700 GS
- F 800 GS

**LINER FOR VARIABLE CASE, RIGHT AND VARIABLE TOPCASE**

**Available for:**

- F 650 GS
- F 700 GS
- F 800 GS

The practical, waterproof liner with removable carry strap keeps its contents well protected. As with the variable case, its capacity is adjustable.



**1 Variable topcase**



**2 Backrest pad for variable topcase**





**SMALL TOPCASE AND BACKREST PAD**

**Available for:**

- F 800 S
- F 800 ST
- F 800 GT
- F 800 R

With a volume of 28 litres, the waterproof topcase offers enough space for a helmet and impresses in daily use and on short tours. It is made of a hard-wearing plastic mix in a double-shell design. Its weight is approx. 5.5 kilograms.

**1 Small topcase, 28 l**



**2 Backrest pad for small topcase**



**LUGGAGE GRID**

**Available for:**

- F 800 S
- F 800 ST
- F 800 GT
- F 800 R



**SMALL LUGGAGE GRID**

**Available for:**

- F 650 GS
- F 700 GS
- F 800 GS
- F 800 GS Adventure



**LINER FOR SMALL TOPCASE**

**Available for:**

- F 800 S
- F 800 ST
- F 800 GT
- F 800 R

The matching liner for the small topcase gets the luggage organised and facilitates loading and unloading. The carry handle and shoulder strap make the bag easy to access and transport. Practical details include the three-sided all-round zipper.



**ATACAMA LUGGAGE SYSTEM**

**1 & 2 Available for:**

- F 800 GS
- F 800 GS Adventure

The Atacama side bags convince with clever details and a combined storage volume of 60 litres. In addition to the waterproof liners, various storage compartments provide additional space. Quick-release fasteners for easy mounting on the motorcycle and sturdy carry handles ensure a secure hold and extremely practical handling.

**3 & 4 Available for:**

- F 800 S
- F 800 ST
- F 800 GT
- F 800 R
- F 650 GS
- F 700 GS
- F 800 GS
- F 800 GS Adventure

The Atacama roll bag made of a robust mix of materials convinces with clever details and a storage volume of 40 litres. In addition to the waterproof liner, various storage compartments provide additional space. The versatile fastening concept, three carry handles and backpack function ensure a secure hold and extremely practical handling.

The Atacama side bags and roll bag and other pieces of luggage or helmets can be secured to the motorcycle using the lockable tension straps with steel core.

For information on speed and load restrictions, please refer to the instruction booklet. Only available in conjunction with case holder for aluminium cases. For information on speed and load restrictions, please refer to the instruction booklet.

**1 Atacama side bags**



**2 Tensioning straps for Atacama side bags, lockable**



**3 Atacama roll bag, 40l**



**4 Tensioning strap for Atacama roll bag, lockable**





## 426 F MODEL RANGE: PREVIOUS MODELS STORAGE

### TANK BAG

#### Available for:

- F 800 GT
- F 800 R

The tank bag is highly practical, with a waterproof main compartment, easy-access map pocket, carry handle and a removable carry strap. The capacity expands from approx. 10 to approx. 14l. Can be combined with the BMW Motorrad Navigator.



### TANK BAG

#### Available for:

- F 650 GS
- F 700 GS
- F 800 GS
- F 800 GS Adventure

Not available for model codes 0B02, 0B12, 0B07, 0B17

Tank bag with waterproof main compartment, A4 map pocket and two splash-proof patch pockets on the sides. The capacity expands from approx. 12 to approx. 17l. Can be combined with the BMW Motorrad Navigator.



### UNIVERSAL TANK BAG

#### Available for:

- F 800 S
- F 800 ST
- F 800 GT
- F 800 R

The waterproof tank bag with a waterproof main compartment fits various BMW Motorrad models. The capacity expands from approx. 10 to approx. 12l. Can be combined with the BMW Motorrad Navigator systems.



### TANK BAG

#### Available for:

- F 800 S
- F 800 ST
- F 800 GT
- F 800 R

Not available for model codes 0B03, 0B13

This tank bag has a large waterproof main compartment (approx. 12l) and a pocket (with window) for smaller items. It fits various BMW Motorrad models and can be combined with BMW Motorrad Navigator systems.



### ENDURO REAR BAG

#### Available for:

- F 650 GS
- F 700 GS
- F 800 GS

Not available for model codes 0B07, 0B17

A highly water-resistant main compartment and handy pockets for small items make this the perfect solution for Enduro riding. It can be mounted on either the rear of the bike or the small luggage carrier.



### HANDLE FOR PASSENGER (NOT SHOWN)

#### Available for:

- F 800 S
- F 800 R

The high-quality handle provides the passenger with secure support in any position while riding and also gives the rider greater freedom of movement. The handle therefore provides significantly greater riding comfort and safety – especially when riding with a passenger on long journeys. This makes mile after mile of riding even more fun.





# DESIGN

## PRIMED PASSENGER SEAT COVER

**Available for:**

- F 800 S
- F 800 ST
- F 800 R

The passenger seat cover gives the motorcycle a sporty single-seater look. It comes pre-primed, so can be painted the same colour as the bike.



## REAR SPRAY GUARD

**Available for:**

- F 650 GS
- F 700 GS
- F 800 GS
- F 800 GS Adventure

Helps protect the rear from dirt on wet surfaces.



## LED INDICATORS

**Available for:**

- F 800 S
- F 800 ST
- F 800 GT
- F 800 R
- F 650 GS
- F 700 GS
- F 800 GS
- F 800 GS Adventure

A shining example: The beautifully designed LED indicators with white turn indicator glass convince with their slim design and modern lighting technology. They respond much faster than incandescent lamps and are virtually wear-free. This provides a clear safety advantage in road traffic.

Note the differences in national-market versions.  
To be fitted and/or enabled in a specialist workshop,  
ideally at your authorised BMW Motorrad Retailer.



## LED REAR LIGHT

**Available for:**

- F 800 S
- F 800 ST
- F 800 GT
- F 800 R

Sleek rear lights with state-of-the-art LED technology fuse style with technical wizardry. Practically wear-free, they increase safety in road traffic.

Note the differences in national-market versions.  
To be fitted and/or enabled in a specialist workshop,  
ideally at your authorised BMW Motorrad Retailer.



## PLASTIC ENGINE SPOILER

**Available for:**

- F 800 S
- F 800 R

The plastic engine spoiler in Black is both stylish and striking.

Not available in conjunction with engine protection bar.



## PLASTIC RADIATOR TRIM

**Available for:**

- F 800 R

A Black single-piece plastic surround for the radiator that coordinates with the intake manifold fairing, rounding off the bike design in dynamic fashion.

Not available in conjunction with engine protection bar.

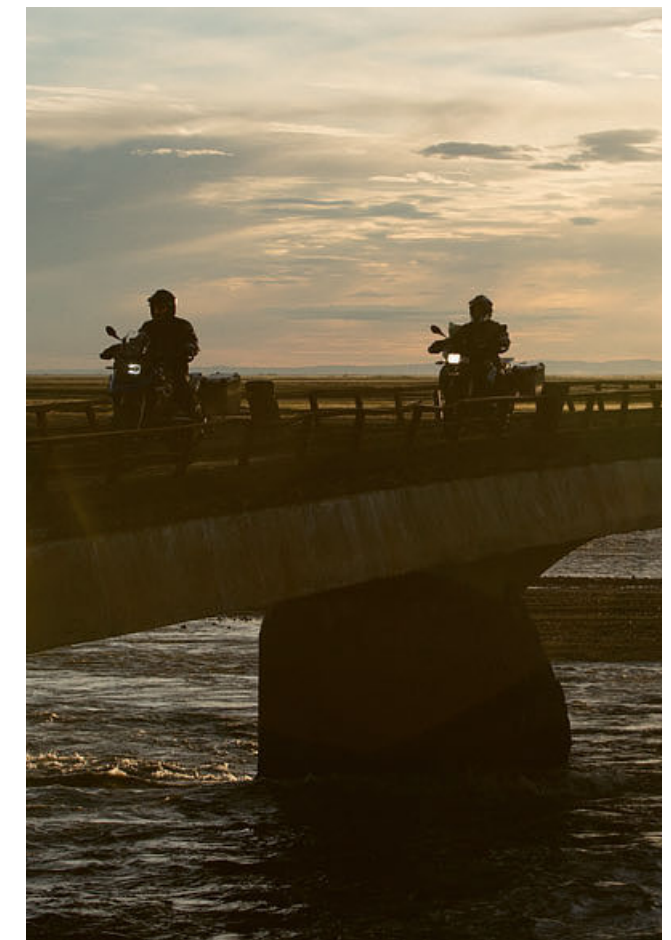



# ERGONOMICS & COMFORT

## WINDSCREENS

**1 Available for:**  
• F 650 GS  
• F 800 GS

**2 & 3 Available for:**  
• F 650 GS  
• F 700 GS  
• F 800 GS

**4 Available for:**  
• F 800 GT

**5 Available for:**  
• F 700 GS

**6 Available for:**  
• F 650 GS  
• F 800 GS

**See next page.**  
**7 Available for:**  
• F 800 R

**8 Available for:**  
• F 800 GT

**9 Available for:**  
• F 800 R

**10 – 13 Available for:**  
• F 800 S  
• F 800 ST

Improves protection against wind and rain, especially on longer journeys. Tinted version also available.

1 Touring windscreen



2 Large windscreen, tinted



3 Large windscreen, clear



4 High windscreen



5 Small windscreen, tinted



6 Small windscreen, clear



7 Windscreen, tinted



8 High windscreen



9 High windscreen



10 High windscreen, tinted



11 Low windscreen



12 Low windscreen, tinted





**SPORT WINDSCREEN**

**Available for:**

- F 800 R
- Not available for model codes 0B04, 0B14, 0B54, 0B64

The varnished windscreen underlines the dynamic design of the F 800 R and provides significant protection from wind when travelling at speed outside built-up areas.

**Available in various colours:**

Alpine white, Fire orange, Granite grey metallic, Light yellow metallic, Magma red, Mineral silver metallic and White aluminium 2 metallic matt.



**WIND DEFLECTOR SET**

**Available for:**

- F 800 GS
- Not available for model codes 0B02, 0B12, 0B07, 0B17



**EXTRA LOW SEAT, BLACK**

**Available for:**

- F 800 S
- F 800 ST
- F 800 GT
- F 800 R

A range of adjustable seats offers riders of all heights the chance to find the safest and most comfortable set-up that suits them.



**LOW SEAT, BLACK**

**1 Available for:**

- F 650 GS
- F 700 GS
- F 800 GS

**2 Available for:**

- F 800 GS Adventure

**3 Available for:**

- F 800 S
- F 800 ST
- F 800 GT
- F 800 R

A range of adjustable seats offers riders of all heights the chance to find the safest and most comfortable set-up that suits them.

1 Low seat, black



2 Low seat, black



3 Low seat, black



**COMFORT SEAT**

**1 Available for:**

- F 650 GS
- F 700 GS
- F 800 GS

**F 650 GS:**

Seat height: 835 mm; step length: 1,840 mm

**F 700 GS:**

Seat height: 835 mm; step length: 1,840 mm

**F 800 GS:**

Seat height: 895 mm; step length: 1,960 mm

**2 & 3 Available for:**

- F 800 GT
  - F 800 R
- Not available for model codes 0217, 0227

**F 800 GT:**

Seat height: 820 mm; step length: 1,858 mm

**F 800 R:**

Seat height: 820 mm; step length: 1,835 mm

A range of adjustable seats offers riders of all heights the chance to find the safest and most comfortable set-up that suits them.

1 Comfort seat



2 Comfort seat



3 High comfort seat



**RALLYE SEAT**

**Available for:**

- F 650 GS
- F 700 GS
- F 800 GS

**F 700 GS and F 650 GS:**

Seat height: 860 mm; step length: 1,870 mm

**F 800 GS:**

Seat height: 920 mm; step length: 1,990 mm





**HIGH SEAT**

- 1 Available for:**
- F 800 GS Adventure
- 2 Available for:**
- F 650 GS
  - F 800 GS
- 3 & 4 Available for:**
- F 800 GS Adventure

**F 800 GS Adventure:**  
Seat height: 890 mm;  
step length: 1,960 mm

**1 High seat, black/stone grey**



**2 High seat, black**



**3 High seat, black/red**



**4 High seat, black/sand cover**



**SEAT, GREY/BLACK**

- Available for:**
- F 700 GS
  - F 800 GS
- Not available for model codes 0219, 0229

**F 700 GS:**  
Seat height: 820 mm;  
step length: 1,810 mm

**F 800 GS:**  
Seat height: 880 mm;  
step length: 1,930 mm



**CENTRE STAND**

- Available for:**
- F 800 R
  - F 700 GS
  - F 800 GT
  - F 800 GS
  - F 800 GS Adventure
- Not available for model codes 0219, 0229



**SEAT, BLACK (NOT SHOWN)**

- Available for:**
- F 800 S
  - F 800 ST
  - F 800 GT
  - F 800 R
- Not available for model codes 0B04, 0B14, 0B54, 0B64

**HEATED GRIPS (NOT SHOWN)**

- Available for:**
- F 800 R
  - F 800 S
  - F 800 ST
  - F 800 GT
  - F 650 GS
  - F 700 GS
  - F 800 GS
  - F 800 GS Adventure

Comfort meets safety. The practical heated grip keeps hands warm even on cold days while being even more responsive.

To be fitted and/or enabled in a specialist workshop, ideally at your authorised BMW Motorrad Retailer.

**WIDE ENDURO FOOTREST**

- Available for:**
- F 700 GS
  - F 800 GS
  - F 800 GS Adventure
- Not available for model codes 0219, 0229

Wide Enduro footrests provide a better foothold and improve control when riding off-road or in a standing position.



**AUTOMATIC CHAIN LUBRICATION SYSTEM**

- Available for:**
- F 800 R
  - F 650 GS
  - F 700 GS
  - F 800 GS
  - F 800 GS Adventure
- Not available for model codes 0B54, 0B64, 0B06, 0B16, 0B07, 0B17

Lubricates the drive chain automatically, whenever the engine is running. Constant lubrication reduces friction within the chain drive, minimizing wear and tear and power loss.

To be fitted and/or enabled in a specialist workshop, ideally at your authorised BMW Motorrad Retailer.



**RUBBER INSERT FOR ENDURO WIDE FOOTREST**

- Available for:**
- F 700 GS
  - F 800 GS
- Not available for model codes 0219, 0229





# NAVIGATION & COMMUNICATION

## BMW MOTORRAD NAVIGATOR VI (INCL. 4-BUTTON CRADLE MOUNT)

**Available for:**

- F 800 S
- F 800 ST
- F 800 GT
- F 800 R
- F 650 GS
- F 700 GS
- F 800 GS
- F 800 GS Adventure

With the multifunctional Navigator VI, route planning becomes child's play. The system with 16 GB flash memory and a five-inch touch screen always shows the right way, and the waterproof display is easy to read even in direct sunlight. The high-resolution screen provides all the essential information and ensures that you can see the big picture required in every situation. Numerous additional functions make planning and touring an exciting experience. Plan your routes can be created according to your personal preferences and enjoy driving on winding and quiet side roads. The "round trip" option is a good choice on unfamiliar terrain, which will reliably lead back to the starting point. The Bluetooth connection to the BMW Motorrad communication system and the optional Smartphone Link app enable multimedia on the go: navigation announcements, telephone calls and music streaming as well as the retrieval of weather forecasts or traffic jam information are no problem. Operation is via the stable Mount Cradle; the four buttons can also be accurately controlled while wearing gloves. Choose the pre-installed map data, and you will always be up to date thanks to lifelong, free map updates.

Only in combination with bracket for navigation systems. Note the differences in national-market versions.



## BMW MOTORRAD SMARTPHONE CRADLE

**Available for:**

- F 800 GT
- F 800 R
- F 650 GS
- F 700 GS
- F 800 GS
- F 800 GS Adventure

BMW Motorrad's robust Smartphone Cradle provides a safe and protected place for your smartphone. This means that useful functions such as navigation information and online information can also be used while you are on the move. Thanks to the handy charging function, your smartphone is also always ready for action on extended bike tours.

Only in combination with bracket for BMW Motorrad navigation systems



# SAFETY

## LARGE SPOILER ATTACHMENTS FOR LARGE HAND PROTECTORS

**Available for:**

- F 650 GS
- F 700 GS
- F 800 GS

The spoiler attachment for the hand protector adds an extra barrier to help keep out wind, rain and flying stones.



## HAND PROTECTORS

**Available for:**

- F 650 GS
- F 700 GS
- F 800 GS

Protect the hands and instruments from wind and rain, and from low-hanging branches and flying stones on off-road trails.

### 1 Large hand protectors



### 2 Small hand protectors



## BOW-SHAPED HAND GUARD

**Available for:**

- F 650 GS
- F 700 GS
- F 800 GS

Not available for model codes 0B53, 0B14, 0B54, 0B64, 0B06, 0B16, 0B07, 0B17





**PLASTIC ENGINE GUARD**

**Available for:**

- F 650 GS
- F 700 GS
- F 800 GS
- F 800 GS Adventure

The small engine engine guard fits seamlessly into the dynamic GS design of the bike. It protects the engine from flying stones during light off-road use, and can be used at the same time as the engine protection bar.

**ENGINE PROTECTION BAR**

**Available for:**

- F 650 GS
- F 700 GS
- F 800 GS

In many situations where impacts with the motorcycle, such as the bike falling over, are unavoidable the robust stainless steel engine protection bar effectively helps prevent damage to the engine.



**ENDURO ALUMINIUM ENGINE GUARD**

**Available for:**

- F 650 GS
- F 700 GS
- F 800 GS
- F 800 GS Adventure

The robust aluminium engine guard protects the engine and manifold from stones and ricochets during off-road riding. It also emphasizes the tough enduro look, especially in combination with the engine protection bar. Does not restrict banking angle or movement of feet, etc.

**HEADLIGHT GUARD  
(FOR OFF-ROAD USE ONLY)**

**Available for:**

- F 650 GS
- F 700 GS
- F 800 GS

Not available for model codes 0B07, 0B17

Protects headlight from flying stones during off-road use. With snaplock system for quick attachment and removal.

Only for off-road use (not homologated for road use).



**LED ADDITIONAL HEADLIGHTS**

**Available for:**

- F 800 GS
  - F 800 GS Adventure
- Not available for model codes 0219, 0229, 0B02, 0B12

The powerful LED additional headlights deliver the necessary perspective when visibility is poor thanks to extended illumination.

To be fitted and/or enabled in a specialist workshop, ideally at your authorised BMW Motorrad Retailer. The additional headlights are approved for use as fog lights, and may only be used in poor weather conditions. Country-specific road traffic regulations apply.



**ANTI-THEFT ALARM SYSTEM  
WITH REMOTE CONTROL  
(NOT SHOWN)**

**Available for:**

- F 800 GT
- F 800 R
- F 650 GS
- F 700 GS
- F 800 GS
- F 800 GS Adventure

Note the differences in national-market versions. To be fitted and/or enabled in a specialist workshop, ideally at your authorised BMW Motorrad Retailer.

The anti-theft alarm system reacts to changes in position and vibrations with a clearly audible signal and a flashing warning lights system.

**ASC (AUTOMATIC STABILITY CONTROL)  
RETROFIT SET, SWITCHABLE  
(NOT SHOWN)**

**Available for:**

- F 800 GT
- Not available for model codes 0B03, 0B13

Controls and optimizes transmission and prevents rear wheel spin – on wet surfaces, for example.

**REAR SPRAY GUARD (NOT SHOWN)**

**Available for:**

- F 800 GT
  - F 800 R
- Not available for model codes 0217, 0227

MAINTENANCE & TECHNOLOGY

**OUTPUT REDUCTION RETROFIT SET (35 KW/48 HP)  
(NOT SHOWN)**

**Available for:**

- F 800 GT



# K MODEL RANGE

HP-PARTS	442	ERGONOMICS & COMFORT	453
STORAGE	445	NAVIGATION & COMMUNICATION	456
DESIGN	451	SAFETY	458

#### Vehicle-specific accessories for:

- K 1200 R  
Model codes 0584, 0594
- K 1200 R Sport  
Model codes 0585, 0595
- K 1200 S  
Model codes 0581, 0591
- K 1200 GT  
Model codes 0587, 0597
- K 1300 R  
Model codes 0518, 0519
- K 1300 S  
Model codes 0508, 0509
- K 1300 GT  
Model codes 0538, 0539
- K 1600 GT  
Model codes 0601, 0611
- K 1600 GTL  
Model codes 0602, 0612
- K 1600 GTL Exclusive  
Model codes 0603, 0613





# HP PARTS

## HP SPORT SILENCER

**1 Available for:**

- K 1300 R
- K 1300 S

The sleek, high-quality titanium slip-on silencer with carbon end-cap and heat shield trim delivers a powerful rumble. Approx. 1.5kg lighter than standard silencer.

**2 Available for:**

- K 1600 GT
- K 1600 GTL
- K 1600 GTL Exclusive

Craftsmanship at its finest: a double-flow slip-on silencer with high-quality conical titanium casing, crossover pipes and mounting system made of stainless steel, plus end-cap made of carbon. With three tailpipes on each side, the BMW K 1600 GT generates a rich, throaty sound to deliver a thrilling riding experience.

To be fitted and/or enabled in a specialist workshop, ideally at your authorised BMW Motorrad Retailer.

1 HP sports silencer



2 HP sports silencer



## HP CARBON HEAT SHIELD TRIM

**Available for:**

- K 1200 R
- K 1200 R Sport
- K 1300 R
- K 1300 S

The HP carbon heat shield trim for the join between the silencer and the exhaust-manifold is a lighter, more stylish alternative to the standard aluminium trim.



## HP CARBON AIR INTAKE

**Available for:**

- K 1200 R



## HP FOOTREST SYSTEMS

**1 Available for:**

- K 1300 R

The HP footrests for K 1200 models add both practicality and style. Multiple adjustment options allow riders to create the ergonomic set-up that suits them. Matching HP passenger footrests are included in the package.

**2 Available for:**

- K 1300 R
- K 1300 S

The HP footrests for K 1300 models differ slightly from other variants but offer comparable functionality. HP passenger footrests must be ordered separately.

To be fitted and/or enabled in a specialist workshop, ideally at your authorised BMW Motorrad Retailer.

1 HP footrest system



2 HP passenger footrests



## HP CARBON ENGINE SPOILER

**Available for:**

- K 1200 R
- K 1200 R Sport
- K 1300 R



## HP FORGED WHEELS

**Available for:**

- K 1200 R
- K 1200 R Sport
- K 1200 S
- K 1300 R
- K 1300 S

Thanks to the use of lightweight-construction techniques, the HP forged wheels are approx. 1.1 kg lighter (per set) than the standard wheels. Reducing the unsprung and rotating mass improves handling and the quality of the suspension.





HP INSTRUMENT CLUSTER

Available for:

- K 1200 R
- K 1200 R Sport
- K 1200 S
- K 1300 R
- K 1300 S

The all-weather HP instrument cluster combines the classic BMW display with a host of racetrack-inspired features – a dream addition for all motorsport enthusiasts.

To be fitted and/or enabled in a specialist workshop, ideally at your authorised BMW Motorrad Retailer.



HP GEAR-SHIFT ASSIST

Available for:

- K 1200 S
- K 1300 R
- K 1300 S

The gear-shift assist enables upshifts without throttle release or using the clutch – just like in pro racing.

To be fitted and/or enabled in a specialist workshop, ideally at your authorised BMW Motorrad Retailer.



HP LABEL

Available for:

- K 1200 R
- K 1200 R Sport
- K 1200 S
- K 1300 R
- K 1300 S

With the self-adhesive HP label, the HP carbon parts can be further customised on request. The silver-coloured inscription on a black background measures 22 x 9 mm.



STORAGE

SPORT CASES

Available for:

- K 1200 R
- K 1200 R Sport
- K 1200 S
- K 1300 R
- K 1300 S

Splash-proof sport cases come with waterproof liners (one per case). Capacity is adjustable from approx. 15 to approx. 25l on each side – ample room for a helmet in each case.



CASE HOLDERS FOR SPORT CASES

Available for:

- K 1200 R
- K 1200 R Sport
- K 1200 S
- K 1300 R
- K 1300 S



LINER FOR SYSTEM CASE

Available for:

- K 1200 GT
- K 1300 GT

Slipping seamlessly into the overall design of the bike, these liners are both stable and lightweight. Handy compartments for small items and carry handles that can be tucked away make them essential travel companions.

Liner for left and right side identical.



PROTECTIVE FILM FOR TOP OF SYSTEM CASES

Available for:

- K 1200 GT
- K 1300 GT

Self-adhesive, protects case paintwork.





**IMPACT PROTECTION SYSTEM FOR SYSTEM CASE**

**Available for:**

- K 1200 GT
- K 1300 GT

Protects lower area against scratches.



**LINER FOR TOURING CASES**

**Available for:**

- K 1600 GT
- K 1600 GTL

The matching liner for the touring case gets the luggage organised and facilitates loading and unloading. The carry handle and shoulder strap make the bag easy to access and transport. The practical details include the outside pocket and the three-sided zipper.

With carry handles and detachable shoulder strap.



**IMPACT PROTECTION SYSTEM AND PROTECTIVE FILM FOR TOURING CASES**

**Available for:**

- K 1600 GT
- K 1600 GTL
- K 1600 GTL Exclusive

**Protective film for touring cases (not shown)**

The impact protection is made of sturdy plastic and protects the touring cases at the front, bottom and sides from scratches and damage. The two moulded parts therefore serve well when the bike has to be manoeuvred into tight parking spaces or narrow passages. But even when transported by hand, the impact protection can take a bump or two.

The self-adhesive and transparent film protects top and side surfaces of touring cases from small scratches.

To be fitted and/or enabled in a specialist workshop, ideally at your authorised BMW Motorrad Retailer.



**LINER FOR EXCLUSIVE TOURING CASES**

**Available for:**

- K 1600 GT
- K 1600 GTL
- K 1600 GTL Exclusive

The matching liner for the Exclusive touring case gets the luggage organised and facilitates loading and unloading. The carry handle and shoulder strap make the bag easy to access and transport. Practical details include the three-sided all-round zip and the outer patch pocket made of soft Alcantara.

**SMALL TOPCASE, 28 L**

**Available for:**

- K 1200 GT
- K 1300 GT

With a volume of 28 litres, the waterproof topcase offers enough space for a helmet and impresses in daily use and on short tours. It is made of a hard-wearing plastic mix in a double-shell design. Its weight is approx. 5.5 kilograms.

**LINER FOR SMALL TOPCASE**

**Available for:**

- K 1200 GT
- K 1300 GT

The matching liner for the small topcase gets the luggage organised and facilitates loading and unloading. The carry handle and shoulder strap make the bag easy to access and transport. Practical details include the three-sided all-round zipper.

1 Liner for Exclusive touring case, left



2 Liner for Exclusive touring topcase





**TOURING TOPCASE, GLACIER SILVER METALLIC, 49 L**

**Available for:**  
• K 1600 GT

**Touring topcase, Dark graphite metallic (not shown)**

The waterproof touring topcase with its 49 litre volume, integrated backrest pad for the passenger, interior lighting and velour carpet lining offers space for two helmets. Two gas pressure shock absorbers support the opening process and underline the impression of high quality.



**ADDITIONAL BRAKE LIGHT FOR TOURING TOPCASE**

**Available for:**  
• K 1600 GT  
• K 1600 GTL  
• K 1600 GTL Exclusive

The additional brake light for the touring topcase with modern LED technology in a white clear-glass look blends perfectly with the existing topcase lid embellisher. Because braking activity can be seen better, this promotes passive safety in traffic.

To be fitted and/or enabled in a specialist workshop, ideally at your authorised BMW Motorrad Retailer.



**LINER FOR TOURING TOPCASE**

**Available for:**  
• K 1600 GT  
• K 1600 GTL

The matching liner for the touring topcase gets the luggage organised and facilitates loading and unloading. The carry handle and shoulder strap make the bag easy to access and transport. Practical details include two external patch pockets and a wide-opening lid.



**STORAGE COMPARTMENT FOR TOURING TOPCASE**

**Available for:**  
• K 1600 GT  
• K 1600 GTL  
• K 1600 GTL Exclusive

The practical solution for documents, stationery or even a netbook: the handy document compartment is secured in the topcase lid with four quick-release fasteners, and helps keep things organised while providing quick access to everything that is important for the trip.



**LARGE TOPCASE, WHITE ALUMINIUM, 49 L**

**Available for:**  
• K 1200 GT  
• K 1300 GT

The waterproof topcase is easy to mount on the luggage grid and has enough space inside for up to two helmets.



**LINER FOR LARGE TOPCASE, 49 L**

**Available for:**  
• K 1200 GT  
• K 1300 GT

Slipping seamlessly into the overall design of the bike, these liners are both sturdy and lightweight. Handy compartments for small items and carry handles that can be tucked away make them essential travel companions.



**TANK BAG**

**Available for:**  
• K 1200 R  
• K 1200 R Sport  
• K 1300 R

Waterproof tank bag with waterproof main compartment and map pocket and a capacity that expands from 13 to 20l. Sturdy construction and materials ensure everything stays in place, even when the bike is moving at high speed.

Cannot be used when BMW Motorrad Navigator is fitted.



**TANK BAG**

**Available for:**  
• K 1200 GT  
• K 1300 GT

A waterproof tank bag with main compartment designed with the ergonomic set-up of sport bike riders in mind. Capacity expands from 13 to 20 l via an all-round zip.



**LARGE TANK BAG**

**Available for:**  
• K 1200 S  
• K 1300 S

Waterproof tank bag with waterproof main compartment and map pocket and a capacity that expands from 13 to 20l. Sturdy construction and materials ensure everything stays in place, even when the bike is moving at speed.

Cannot be used when BMW Motorrad Navigator is fitted.





**UNIVERSAL TANK BAG**

**Available for:**

- K 1200 R
- K 1200 R Sport
- K 1200 S
- K 1300 R
- K 1300 S

This tank bag with waterproof main compartment fits various BMW Motorrad models. The capacity expands from approx. 10 to approx. 12l. Can be combined with BMW Motorrad Navigator systems.

**TANK BAG**

**Available for:**

- K 1200 R
- K 1200 R Sport
- K 1200 S
- K 1300 R
- K 1300 S

This tank bag has a large waterproof main compartment (approx. 12l) and a pocket (with window) for smaller items. It fits various BMW Motorrad models and can be combined with BMW Motorrad Navigator systems.

**TANK BAG**

**Available for:**

- K 1600 GT

The waterproof main compartment of the tank bag can be expanded from 10 to 12 litres and features a small view pocket with a removable panel. There are two outer pockets and one inner pocket for small parts. The practical variable insert is also suitable for dividing the interior of the tank bag. With carry handle and detachable shoulder strap.

For information on speed and load limitations, please refer to the instruction booklet.



**LUGGAGE CARRIER**

**Available for:**

- K 1200 S
- K 1300 S

**Luggage carrier (not shown) available for:**

- K 1200 R
- K 1200 R Sport
- K 1300 R



DESIGN

**LED REAR LIGHT**

**Available for:**

- K 1200 R
- K 1200 R Sport
- K 1200 S
- K 1300 R
- K 1300 S

Sleek rear lights with state-of-the-art LED technology fuse style with technical wizardry.

Practically wear-free, they increase safety in road traffic.

Note the differences in national-market versions. To be fitted and/or enabled in a specialist workshop, ideally at your authorised BMW Motorrad Retailer.



**LED FLASHING TURN INDICATORS AND REAR LED FLASHING TURN INDICATORS**

**Available for:**

- K 1200 R
- K 1200 R Sport
- K 1300 R

A shining example: The beautifully designed LED indicators with white turn indicator glass convince with their slim design and modern lighting technology. They respond much faster than incandescent lamps and are virtually wear-free. This provides a clear safety advantage in road traffic.

Note the differences in national-market versions. To be fitted and/or enabled in a specialist workshop, ideally at your authorised BMW Motorrad Retailer.



**OPTION 719 FORGED WHEEL**

**Available for:**

- K 1600 GT
- K 1600 GTL
- K 1600 GTL Exclusive

The high-quality Classic forged wheel of the exclusive Option 719 presents itself in an elegant two-colour look with all-round polish milling. The special surface treatment with detailed milling contours and the nine-spoke design give the touring bikes a soft and particularly valuable appearance.

To be fitted and/or enabled in a specialist workshop, ideally at your authorised BMW Motorrad Retailer.

**1 Option 719 Classic forged wheels, front**



**2 Option 719 Classic forged wheels, rear**





**CHROME PARTS**

**1 - 5 Available for:**

- K 1600 GT
- K 1600 GTL
- K 1600 GTL Exclusive

Choose the look you want: these elegant, high-quality chrome parts can be combined as you wish, giving your BMW K 1600 GT or GTL a unique, stylish edge.

To be fitted and/or enabled in a specialist workshop, ideally at your authorised BMW Motorrad Retailer.

**6 Available for:**

- K 1600 GT
- K 1600 GTL

**1 Chrome-plated windscreen trim**



**2 Chrome-plated expansion tank cap**



**3 Chrome-plated case strip**



**4 Chrome-plated coolant hose cover**



**5 Chrome-plated touring topcase lid trim**



**6 Chrome-plated slipstream deflector**



# ERGONOMICS & COMFORT

**TINTED WINDSCREEN**

**Available for:**

- K 1200 S
- K 1300 S

The tinted windscreen gives the bike a sporty look. Same design and size as the clear windscreen.



**LARGE WINDSCREEN**

**Available for:**

- K 1200 GT
- K 1300 GT

Providing the rider with even better protection from wind and rain, the large windscreen is ideal for longer tours.

To be fitted and/or enabled in a specialist workshop, ideally at your authorised BMW Motorrad Retailer.



**LOW WINDSCREEN**

**Available for:**

- K 1600 GT
- K 1600 GTL
- K 1600 GTL Exclusive

The low windscreen gives the bike a sporty look and offers good protection against wind and weather.

To be fitted and/or enabled in a specialist workshop, ideally at your authorised BMW Motorrad Retailer.



**COMFORT WINDSCREEN**

**Available for:**

- K 1600 GT
- K 1600 GTL
- K 1600 GTL Exclusive

The scratch-resistant comfort windscreen is higher than the standard windscreen and offers maximum wind and weather protection for rider and passenger.

To be fitted and/or enabled in a specialist workshop, ideally at your authorised BMW Motorrad Retailer.



**SPORT WINDSCREEN, TINTED**

**Available for:**

- K 1200 R
- K 1300 R

To be fitted and/or enabled in a specialist workshop, ideally at your authorised BMW Motorrad Retailer.



**GT WINDSCREEN**

**Available for:**

- K 1600 GT
- K 1600 GTL
- K 1600 GTL Exclusive

The GT windscreen underlines the dynamic appearance of the motorcycle and offers good protection against wind and weather.

To be fitted and/or enabled in a specialist workshop, ideally at your authorised BMW Motorrad Retailer.





**SEAT, BLACK  
(NOT SHOWN)**

**Available for:**

- K 1200 R
- K 1200 R Sport
- K 1300 R

**LOW SEAT, BLACK**

**Available for:**

- K 1200 R
- K 1200 R Sport
- K 1300 R

**PASSENGER COMFORT SEAT**

**Available for:**

- K 1200 R
- K 1200 R Sport
- K 1300 R

Increases passenger comfort and makes the bike even more of an all-rounder. The passenger area is significantly wider and more padded than the standard seat (rider section unchanged).

Not available in conjunction with HP carbon seat cover.



**ONE-PIECE SEAT**

**Available for:**

- K 1600 GT
- K 1600 GTL

The wider one-piece seat with decorative stitching is generously padded and offers excellent comfort for both rider and passenger alike when touring. It is available in three seat heights – 750, 780 and 810 mm – and can be heated.

**Low one-piece seat  
(not shown)**



**ARMRESTS FOR PASSENGER**

**Available for:**

- K 1600 GTL
- K 1600 GTL Exclusive

The padded armrests for the passenger offer relaxed travel comfort and can be easily folded up for conveniently getting on and off.

To be fitted and/or enabled in a specialist workshop, ideally at your authorised BMW Motorrad Retailer.



**HEIGHT-ADJUSTABLE RIDER SEAT,  
LOW**

**Available for:**

- K 1600 GT
- K 1600 GTL

The low rider's seat in black makes it easier to get on and off and improves ground accessibility. The motorcycle is thereby easier to manoeuvre and control. The seat is height-adjustable in two stages, and the lower inner leg curve offers the rider a high degree of seating comfort, even on longer journeys.



**LOW RIDER SEAT  
(NOT SHOWN)**

**Available for:**

- K 1200 GT
- K 1300 GT

Available in the colours grey and black and optionally as heated versions

**LED GROUND-LEVEL LIGHTING**

**Available for:**

- K 1600 GT
- K 1600 GTL
- K 1600 GTL Exclusive

Safe parking after sunset: the LED floor lighting illuminates the area under the bike and makes it easier to find a suitable standing space in the dark. In addition, getting off the bike and operating the main or side stands is even more secure. Even small items such as keys or coins are easier to find.

Note the differences in national-market versions. To be fitted and/or enabled in a specialist workshop, ideally at your authorised BMW Motorrad Retailer. K48: Only available in conjunction with OE 417 (central locking system).



**HEATED GRIPS AND SWITCHES**

**Available for:**

- K 1200 R
- K 1200 R Sport
- K 1200 S
- K 1200 GT
- K 1300 R
- K 1300 S
- K 1300 GT

Keep your hands as warm as you like with retrofittable heated grips.

To be fitted and/or enabled in a specialist workshop, ideally at your authorised BMW Motorrad Retailer.



Original BMW Motorrad equipment is available from your authorised BMW Motorrad Retailer.

**CRUISE CONTROL RETROFIT SET  
(NOT SHOWN)**

**Available for:**

- K 1600 GT
- K 1600 GTL
- K 1600 GTL Exclusive

The electronic cruise control can be activated from 30 km/h and keeps the riding speed constant. This makes it possible to enjoy longer motorway stretches in a relaxed style. The function is deactivated on braking, and the selected speed is automatically adopted after activating the Resume button.

To be fitted and/or enabled in a specialist workshop, ideally at your authorised BMW Motorrad Retailer.

**COMFORT FOOTREST, MAGNESIUM  
MATT, FRONT AND REAR  
(NOT SHOWN)**

**Available for:**

- K 1600 GT

To be fitted and/or enabled in a specialist workshop, ideally at your authorised BMW Motorrad Retailer.

**HILL START CONTROL RETROFIT SET  
(NOT SHOWN)**

**Available for:**

- K 1600 GT
- K 1600 GTL
- K 1600 GTL Exclusive

The Hill Start Control (HSC) drive-off assistant can be retrofitted using an enabling code.

To be fitted and/or enabled in a specialist workshop, ideally at your authorised BMW Motorrad Retailer.



# NAVIGATION & COMMUNICATION

## BMW MOTORRAD NAVIGATOR VI (INCL. 4-BUTTON CRADLE MOUNT)

**Available for:**

- K 1200 R
- K 1200 R Sport
- K 1200 S
- K 1200 GT
- K 1300 R
- K 1300 S
- K 1300 GT

With the multifunctional Navigator VI, route planning becomes child's play. The system with 16 GB flash memory and a five-inch touch screen always shows the right way, and the waterproof display is easy to read even in direct sunlight. The high-resolution screen provides all the essential information and ensures that you can see the big picture required in every situation. Numerous additional functions make planning and touring an exciting experience. Plan your routes can be created according to your personal preferences and enjoy driving on winding and quiet side roads. In unknown terrain, the "round trip" option is a good choice as it reliably guides the rider at the end of the tour back to the starting point. The Bluetooth connection to the BMW Motorrad communication system and the optional Smartphone Link app enable multimedia on the go: navigation announcements, telephone calls and music streaming as well as the retrieval of weather forecasts or traffic jam information are no problem. Operation is via the stable Mount Cradle; the four buttons can also be accurately controlled while wearing gloves. Choose the pre-installed map data, and you will always be up to date thanks to lifelong, free map updates.

Only in combination with bracket for navigation systems. Note the differences in national-market versions.



## BMW MOTORRAD NAVIGATOR VI

**Available for:**

- K 1600 GT
- K 1600 GTL
- K 1600 GTL Exclusive

Not only touring fans will have plenty of choice with the Navigator VI. The system makes route planning child's play and offers numerous additional functions that make every tour an exciting experience. The five inch touch screen is waterproof, easy to read even in direct sunlight and ensures that you can see the big picture required in every situation.

Note the differences in national-market versions.  
 Only available in conjunction with OE navigation preparation.



## BMW MOTORRAD SMARTPHONE CRADLE

**Available for:**

- K 1200 R
- K 1200 R Sport
- K 1200 S
- K 1200 GT
- K 1300 R
- K 1300 S
- K 1300 GT

BMW Motorrad's robust smartphone cradle provides a safe and protected place for your smartphone. This means that useful functions such as navigation information and online information can also be used while you are on the move. Thanks to the handy charging function, your smartphone is also always ready for action on extended bike tours.

Only in combination with bracket for BMW Motorrad navigation devices.



## AUDIO SYSTEM RETROFIT SET (NOT SHOWN)

**Available for:**

- K 1600 GT
- K 1600 GTL
- K 1600 GTL Exclusive

The audio system with radio function has MP3 player, iPod and USB stick interfaces. Operation is via the Multi-Controller on the handlebars or the radio control panel. The station, the current music track or the selected volume are displayed on the info screen.

Please note the specifications for different countries.



Original BMW Motorrad equipment is available from your authorised BMW Motorrad Retailer.



# SAFETY

## ENGINE PROTECTION BAR

- Available for:**
- K 1600 GT
  - K 1600 GTL

The two-piece engine protection bar, made of matt blasted stainless steel, protects the engine housing against damage and fits in perfectly with the classy overall design of the motorcycle.



## CENTRE STAND

- Available for:**
- K 1200 R
  - K 1200 R Sport
  - K 1200 S
  - K 1300 R
  - K 1300 S



## ADDITIONAL SWITCH FOR LED ADDITIONAL HEADLIGHTS (NOT SHOWN)

- Available for:**
- K 1600 GT
  - K 1600 GTL
  - K 1600 GTL Exclusive

## ACTIVATION CODE FOR DTC (NOT SHOWN)

- Available for:**
- K 1600 GT
  - K 1600 GTL

Dynamic Traction Control (DTC) ensures greater riding stability and controls wheel slip even when leaning into corners to prevent the rear wheel from spinning. Depending on the riding mode, DTC allows more or less slip and thus guarantees the maximum safety and riding dynamics on different routes.

To be fitted and/or enabled in a specialist workshop, ideally at your authorised BMW Motorrad Retailer.

## ANTI-THEFT ALARM SYSTEM WITH REMOTE CONTROL (NOT SHOWN)

- Available for:**
- K 1200 R
  - K 1200 R Sport
  - K 1200 S
  - K 1200 GT
  - K 1300 R
  - K 1300 S
  - K 1300 GT

The anti-theft alarm system reacts to changes in position and vibrations with a clearly audible signal and a flashing warning lights system. Thanks to the warning, passers-by quickly become aware. The system is conveniently activated by remote control.

Note the differences in national-market versions. To be fitted and/or enabled in a specialist workshop, ideally at your authorised BMW Motorrad Retailer.

## TYRE PRESSURE CONTROL RETROFIT SET (NOT SHOWN)

- Available for:**
- K 1600 GT
  - K 1600 GTL
  - K 1600 GTL Exclusive

Tyre Pressure Control (TPC) with all functions can be retrofitted by installing the control unit. TPC provides reliable information about the current tyre pressure and warns the rider about pressure loss at an early stage. The corresponding notifications and instructions are provided by the on-board computer in the cockpit.

To be fitted and/or enabled in a specialist workshop, ideally at your authorised BMW Motorrad Retailer.

## ASC (AUTOMATIC STABILITY CONTROL) RETROFIT SET, SWITCHABLE (NOT SHOWN)

- Available for:**
- K 1200 S
  - K 1300 GT

## TRIM, BLACK STORM METALLIC MATT (NOT SHOWN)

- Available for:**
- K 1600 GT





# S MODEL RANGE

HP PARTS	462	ERGONOMICS & COMFORT	476
STORAGE	473	NAVIGATION & COMMUNICATION	478
DESIGN	474	SAFETY	479

#### Vehicle-specific accessories for:

- S 1000 R  
Model codes 0D02, 0D12
- S 1000 RR  
model codes 0507, 0517, 0524, 0534, 0D10, 0D21, 0D50, 0D60
- HP 4  
model codes 0D01, 0D11





# HP PARTS

## HP SPORT SILENCER

### 1 & 4 Available for:

- S 1000 RR
- Only available for model codes 0D10, 0D21

### 2 Available for:

- S 1000 RR
- Only available for model codes 0D50, 0D60

### 3 Available for:

- S 1000 R
  - S 1000 RR
- Only available for model codes 0507, 0517, 0524, 0534

### HP sports silencer, silver (not shown) available for:

- S 1000 RR
- Only available for model codes 0D50, 0D60

The HP sports silencer is completely made of titanium and its excellent sound makes every ride a sporty experience. Thanks to its lightweight titanium design, the end cap and the large carbon heat shield, it also weighs less than the standard silencer.

1 HP sports silencer



2 HP sports silencer, black



3 HP sports silencer



4 HP titanium exhaust system

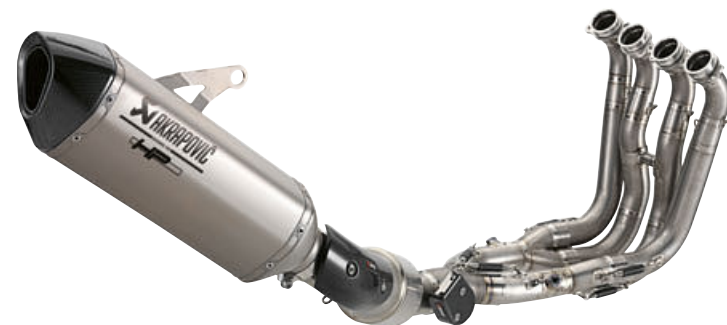

## HP TITANIUM EXHAUST SYSTEM

### Available for:

- S 1000 RR
- Only available for model codes 0507, 0517, 0524, 0534

The HP titanium exhaust system from Akrapovič with a carbon end cap not only enhances the sporty appearance but also the performance of the bike. Compared to the standard version, it offers a significant reduction in weight and an increase in engine torque, especially in the medium speed range.

To be fitted and/or enabled in a specialist workshop, ideally at your authorised BMW Motorrad Retailer.



## HP TITANIUM EXHAUST SYSTEM

### Available for:

- S 1000 R
- Only available for model codes 0D02, 0D12

The HP titanium exhaust system from Akrapovič with a carbon end cap not only enhances the sporty appearance but also the performance of the bike. Compared to the standard version, it offers a significant reduction in weight and an increase in engine torque, especially in the medium speed range. This leads to a very sensitive throttle response in all riding modes.

To be fitted and/or enabled in a specialist workshop, ideally at your authorised BMW Motorrad Retailer.



## HP FRONT SILENCER

### Available for:

- S 1000 RR
- Only available for model codes 0D50, 0D60

The HP titanium front silencer offers a visual enhancement and a throaty sound. It is the perfect supplement to the high-performance HP titanium exhaust system from Akrapovič and contributes to significant weight saving.

Only available in conjunction with HP sport silencer or sport silencer in black.

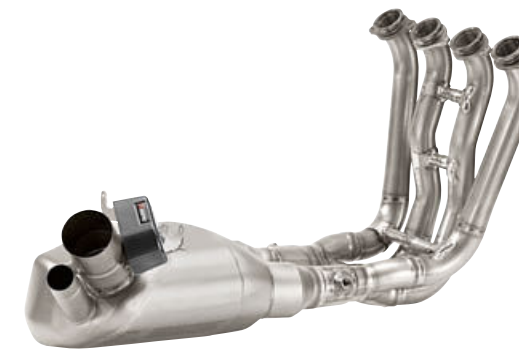

## HP POWER KIT

### Available for:

- S 1000 RR
- Only available for model codes 0D10, 0D21, 0D50, 0D60

Fit for the racetrack: the HP power kit combines the titanium exhaust system with special racing software for engine control, optimised and extended riding modes as well as DTC, Launch Control, anti-wheelie function and pit lane limiter. This means that the bike weighs almost 5 kg less than the standard trim.

Only for track use (not homologated for road use).  
To be fitted and/or enabled in a specialist workshop, ideally at your authorised BMW Motorrad Retailer.





**HP POWER KIT**

**Available for:**

- S 1000 RR
- Only available for model codes 0D10, 0D21, 0D50, 0D60

When combined with the HP titanium exhaust system, the HP power kit dramatically reduces weight and increases performance. Ideal for high-level racetrack riders and private racing teams.

Only for track use (not homologated for road use).  
To be fitted and/or enabled in a specialist workshop, ideally at your authorised BMW Motorrad Retailer.



**FOLDING HP HAND LEVERS**

**1 & 2 Available for:**

- S 1000 R
  - S 1000 RR
- Not available for model codes 0D10, 0D21, 0D50, 0D60

**3 Available for:**

- S 1000 RR
- Only available for model codes 0507, 0517, 0524, 0534

**HP folding clutch lever (not shown) available for:**

- S 1000 RR
  - HP 4
- Not available for model codes 0D10, 0D21, 0D50, 0D60

**HP clutch lever, black (not shown) available for:**

- S 1000 RR
  - HP 4
- Not available for model codes 0D10, 0D21

The CNC-milled HP brake levers made of corrosion-resistant anodised aluminium emphasise the motorbike's sportiness in a particularly impressive manner.

To be fitted and/or enabled in a specialist workshop, ideally at your authorised BMW Motorrad Retailer.

**1 Folding HP clutch lever**



**2 Folding HP clutch lever**



**3 HP handbrake lever with remote adjustment**



**FOLDING HP BRAKE LEVER, BLACK**

**Available for:**

- S 1000 RR
  - HP 4
- Not available for model codes 0D10, 0D21, 0D50, 0D60

The all-weather HP instrument cluster combines the classic BMW display with a host of racetrack-inspired features – a dream addition for all motorsport enthusiasts.



**HP RIDER FOOTRESTS**

**1 Available for:**

- S 1000 R
  - S 1000 RR
- Not available for model codes 0D50, 0D60

**2 Available for:**

- S 1000 RR
- Only available for model codes 0D10, 0D21, 0D50, 0D60

**3 Available for:**

- S 1000 RR
- Only available for model codes 0D10, 0D21

The HP rider footrest system is adjustable in many ways and offers ergonomic qualities as well as maximum variability. The high-quality milled parts made of anodised aluminium can be adapted to a sporty riding style or different rider statures and thus ensure even better control, for example in an inclined position.

**1 HP rider footrest system**



**2 HP rider footrest system, left**

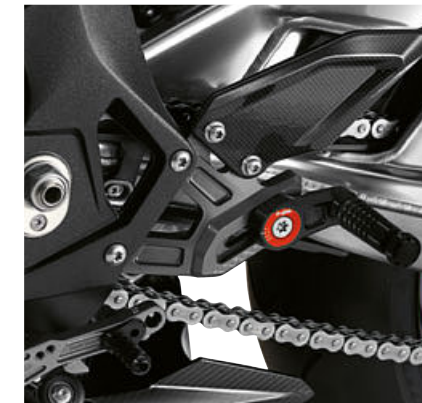

**3 HP rider footrest system, right**



**HP PASSENGER FOOTRESTS**

**1 Available for:**

- S 1000 R
- S 1000 RR

**2 Available for:**

- S 1000 R

The HP passenger footrests are milled from an anodised aluminium alloy and give the bike an even sportier appearance.

**HP CHAIN TENSIONER**

**Available for:**

- S 1000 R
- S 1000 RR
- HP 4

The HP chain tensioner offers high-precision adjustment of chain tension and rear-wheel alignment. It is securely attached to the swinging arm, which makes it easier to install and remove the rear wheel. The precise scale glued to the swinging arm guarantees high reading accuracy.

**1 HP passenger footrests**



**2 HP passenger footrests, black**





**466 S MODEL RANGE: PREVIOUS MODELS  
HP PARTS**

**HP HAND LEVER PROTECTORS**

**Available for:**

- S 1000 R
- S 1000 RR

Not available for model codes 0507, 0517, 0524, 0534

With its dynamic look, the hand lever protectors also make a clear statement of uncompromising sportiness on the road.

**1**  
Only available in conjunction with HP clutch lever.



**HP ASSEMBLY STAND MOUNTING**

**Available for:**

- S 1000 R
- S 1000 RR
- HP 4

The high-quality HP assembly stand mounting is made of high-strength, CNC-milled aluminium and enables the use of the rear Sport assembly stand. The existing rollers prevent the assembly stands from slipping and thus protect the motorcycle from possible scratches.



**HP CARBON WHEEL COVERS AND MOUNTINGS**

**Available for:**

- S 1000 R
- S 1000 RR
- HP 4

Not available for model codes 0D50, 0D60

The HP carbon wheel cover protects rider and motorbike – and emphasises the bike dynamics with the right sporty look.

**1**  
To be fitted and/or enabled in a specialist workshop, ideally at your authorised BMW Motorrad Retailer.

**1 HP carbon front wheel cover**



**2 HP carbon rear wheel cover**



**HP AXLE PROTECTORS**

**Available for:**

- S 1000 R
- S 1000 RR
- HP 4

The HP axle protectors made of highly abrasion-resistant plastic protect the fork and swinging arm from scratches if the bike falls or tips over.

**HP ENGINE PROTECTOR**

**Available for:**

- S 1000 R
- S 1000 RR
- HP 4

The HP engine protector offers improved protection against damage to engine components with its replaceable plastic slip pads.

K49: Not available in conjunction with engine protection bar. All: To be fitted and/or enabled in a specialist workshop, ideally at your authorised BMW Motorrad Retailer.

**1 HP engine guard, left**



**2 HP engine guard, right**



**HP FORGED WHEELS**

**Available for:**

- S 1000 R
- S 1000 RR
- HP 4

The black anodised HP forged front wheel offers improved handling and suspension characteristics thanks to its weight advantage.

To be fitted and/or enabled in a specialist workshop, ideally at your authorised BMW Motorrad Retailer.



**HP CARBON UPPER FAIRING SIDE PANEL**

**Available for:**

- S 1000 RR
- Only available for model codes 0D10, 0D21, 0D50, 0D60

The high-quality HP carbon side trim panel for the upper left or right side combines an elegant look with the perfection of a lightweight, high-tech material.



Original BMW Motorrad equipment is available from your authorised BMW Motorrad Retailer.

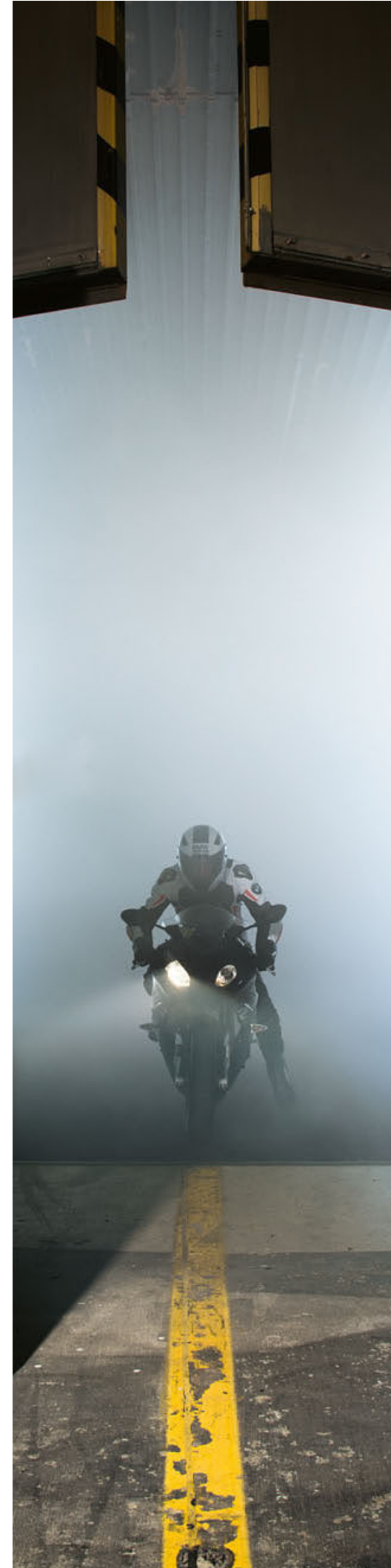



**HP CARBON CHAIN GUARD**

**Available for:**

- S 1000 R
- S 1000 RR
- HP 4

The high-quality HP carbon chain guard combines an elegant look with the perfection of a lightweight, high-tech material.

To be fitted and/or enabled in a specialist workshop, ideally at your authorised BMW Motorrad Retailer.



**HP LABEL**

**Available for:**

- S 1000 RR
- HP 4

Not available for model codes 0D50, 0D60

With the self-adhesive HP label, the HP carbon parts can be further customised on request.



**HP CARBON TANK TRIM / FUEL FILLER CAP COVER**

**Available for:**

- S 1000 R
- S 1000 RR
- HP 4

The HP carbon tank cover with its particularly impact-resistant and UV-resistant high-gloss paintwork is an unmistakable highlight in terms of sportiness.



**HP CARBON AIRBOX COVER**

**Available for:**

- S 1000 R
- S 1000 RR

Not available for model codes 0507, 0517, 0524, 0534

The airbox provides optimal air supply – the HP carbon airbox cover the matching look, thus highlighting the sporty design.



**HP CARBON ENGINE SPOILER AND HEAT PROTECTION SHIELD**

**1 Available for:**

- S 1000 RR

Only available for model codes 0D10, 0D21

**2 Available for:**

- HP 4

**Engine spoiler heat protection shield (not shown) available for:**

- S 1000 R

For simultaneous fitting of engine spoiler and HP titanium exhaust system.

**Engine spoiler heat protection shield (not shown) available for:**

- S 1000 RR

Only available for model codes 0D10, 0D21, 0D50, 0D60

**1 HP carbon engine spoiler**



**2 HP carbon engine spoiler, long**





**HP CARBON SPROCKET COVER**

- Available for:**
- S 1000 R
  - S 1000 RR



**HP TYRE WARMERS**

- Available for:**
- S 1000 RR
  - HP 4

The professional HP tyre warmers allow quick and even heating of tyre and rim for maximum grip.



**HP RIDER SEAT**

- Available for:**
- S 1000 R
  - S 1000 RR
  - HP 4

The HP rider's seat has been specially designed for racetrack use and, thanks to its optimised contour and anti-slip surface, offers significantly more support when accelerating, braking and cornering. In addition, the seat, which rises to the rear, offers a 20 millimetres higher seat position.



**HP BRAKE BLEED VALVE AND AID**

- Available for:**
- S 1000 RR
  - HP 4
- Not available for model codes 0D10, 0D21

The HP brake bleed assistant with vacuum bellows, hose adapter and hose facilitates the bleeding of the brake system by means of vacuum. For this purpose, the compressed bellows and the transparent silicone hose are attached to the bleed valve. The system is then bled by pumping with the brake lever.



**HP DATA LOGGER**

- Available for:**
- S 1000 R
  - S 1000 RR
  - HP 4

The HP data logger permanently stores the relevant riding data, which can then be analysed to improve lap times.



**HP CARBON WINDSCREEN**

- Available for:**
- S 1000 R

The high-quality HP carbon windscreen signals sportiness with its look. It is coated with UV-resistant high-gloss paintwork and is therefore particularly impact-proof. The high-quality carbon design also makes the windscreen very light and thus reduces the overall weight of the motorbike.



**HP COVER KIT**

- Available for:**
- S 1000 R
  - S 1000 RR
  - HP 4

When the mirrors, turn indicators and licence plate holder are removed for use on the racetrack, the corresponding mounts can be covered with the HP cover kit. It contains two covers each for the mirrors and turn indicators at the front as well as another one for the rear underside.



**HP BRAKE PADS**

- Available for:**
- S 1000 RR

The HP brake pads impress with features optimised for the racetrack. Without vehicle type approval.

Only for track use (not homologated for road use).



**CALIBRATION KIT**

- Available for:**
- S 1000 RR
  - HP 4
- Not available for model codes 0524, 0534, 0D10, 0D21, 0D50, 0D60  
Only for track use (not homologated for road use).

- HP Race calibration kit 3 (not shown) available for:**
- S 1000 RR
- Only available for model codes 0D10, 0D21, 0D50, 0D60

- HP Race calibration kit diagnostic cable (not shown) available for:**
- S 1000 RR
- Only available for model codes 0D50, 0D60

Allows riders to customize a range of engine management parameters and fine-tune performance on the racetrack.



**HP GEAR-SHIFT ASSIST**

- Available for:**
- S 1000 R
  - S 1000 RR
  - HP 4
- Not available for model codes 0D10, 0D21, 0D50, 0D60

Change gears like the pros on the track: the HP gear-shift assist minimizes shift times, and enables faster upshifts without throttle release or use of the clutch.

To be fitted and/or enabled in a specialist workshop, ideally at your authorised BMW Motorrad Retailer.





HP CARBON CROSSBEAM (NOT SHOWN)

**HP carbon peg  
available for:**

- S 1000 R

Only available in conjunction with HP titanium exhaust system.

**HP carbon peg  
available for:**

- S 1000 RR
- HP 4

Not available for model codes 0D10, 0D21, 0D50, 0D60

Only in conjunction with HP titanium exhaust system/  
HP power kit.

**HP carbon peg  
available for:**

- S 1000 RR

Only available for model codes 0D10, 0D21

Only in conjunction with HP titanium exhaust system,  
HP power kit or HP sports silencer.

The lightweight HP carbon peg in the racing look is intended for mounting the rear silencer when the passenger footrest system is removed.



# STORAGE

**TANK BAG**

**Available for:**

- S 1000 R
- S 1000 RR

Not available for model codes 0507, 0517, 0524, 0534

The tank bag with a waterproof main compartment and strap fastening holds 13 litres and is adapted to the tank geometry.

For information on speed and load limitations, please refer to the instruction booklet.



**SADDLE BAGS**

**Available for:**

- S 1000 R
- S 1000 RR

Not available for model codes 0507, 0517, 0524, 0534

The stowage space of the saddlebags made of durable polyester can be expanded from around 10 to up to 16 litres per side.

For information on speed and load limitations, please refer to the instruction booklet.



**REAR BAG 25-32L**

**Available for:**

- S 1000 R
- S 1000 RR

Not available for model codes 0507, 0517, 0524, 0534

The robust rear bag with its waterproof main compartment and water-repellent outer pockets offers a volume from 25 to 32 litres.

Not available in conjunction with the comfort passenger seat or passenger seat cover. For information on speed and load limitations, please refer to the instruction booklet.



**BAG FOR PASSENGER SEAT**

**Available for:**

- S 1000 R
- S 1000 RR

Not available for model codes 0507, 0517, 0524, 0534

The waterproof passenger seat bag with 2.5 litre stowage space can be expanded to 5.5 litres – just the right size for a day trip.

Not available in conjunction with the passenger seat cover. For information on speed and load limitations, please refer to the instruction booklet.





# DESIGN

## LED INDICATORS

- Available for:**
- S 1000 R
  - S 1000 RR
  - HP 4

The elegant LED indicators with white indicator glass set standards in terms of design and function.

Note the differences in national-market versions.  
To be fitted and/or enabled in a specialist workshop,  
ideally at your authorised BMW Motorrad Retailer.



## ENGINE SPOILER AND ATTACHMENT SET

- Erhältlich für:**
- S 1000 R

The engine spoiler upgrades the bike and highlights its dynamic character.

**1&2**

To be fitted and/or enabled in a specialist workshop, ideally at your authorised BMW Motorrad Retailer.

- Motorspoiler Lightwhite & Befestigung für Motorspoiler (ohne Abbildung) erhältlich für:**
- S 1000 R

1 Engine spoiler, Racing red



2 Engine spoiler, Black storm metallic



3 Engine spoiler, Frozen dark blue metallic

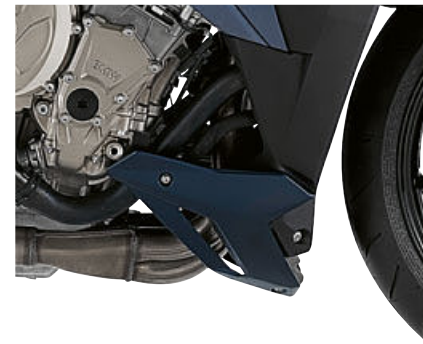

## SEAT HUMP COVER

- Available for:**
- S 1000 R
  - S 1000 RR

Not available for model codes 0507, 0517, 0524, 0534

Not available in conjunction with the rear bag or passenger seat bag.

The high-quality seat hump cover allows the double seat to be quickly and easily converted into a sporty single-seater.

**Available in these colours:**

Alpine white, Frozen dark blue metallic, Granite grey metallic matt, Light grey metallic, Racing red, Sapphire black metallic, Thunder grey metallic and Black storm metallic.

1 Tail-hump cover, Racing red



2 Tail-hump cover, Racing red





# ERGONOMICS AND COMFORT

## TINTED WINDSCREEN

### 1 Available for:

- S 1000 RR
- Not available for model codes 0507, 0517, 0524, 0534

### 2 Available for:

- S 1000 RR
  - HP 4
- Only available for model codes 0524, 0534, 0D01, 0D11

The tinted windscreen emphasises the sporty look of the motorcycle. The special coating also permanently prevents scratches.

## SPORT WINDSCREEN, TINTED

### Available for:

- S 1000 R

The tinted sport windscreen underlines the dynamic appearance of the motorcycle and offers good protection against wind and weather.

Note the differences in national-market versions. To be fitted and/or enabled in a specialist workshop, ideally at your authorised BMW Motorrad Retailer.

### 1 Tinted windscreen



### 2 Tinted windscreen



## HIGH WINDSCREEN

### Available for:

- S 1000 RR
- Not available for model codes 0507, 0517, 0524, 0534

The high windscreen in typical racing bubble form noticeably relieves wind pressure from the upper body at higher speeds and increases comfort.

## HIGH WINDSCREEN, TINTED

### 1 Available for:

- S 1000 RR
- Not available for model codes 0507, 0517, 0524, 0534

### 2 Available for:

- S 1000 RR
  - HP 4
- Only available for model codes 0507, 0517, 0524, 0534, 0D01, 0D11

The high, tinted windscreen in typical race bubble form relieves wind pressure from the upper body at higher speeds and increases comfort.

### 1 High windscreen, tinted



### 2 High windscreen, tinted



### 2 High windscreen, tinted



## COMFORT SEAT AND COMFORT PASSENGER SEAT

### Available for:

- S 1000 R
- S 1000 RR
- HP 4

Not available for model codes 0507, 0517

### 2

Not available in conjunction with the rear bag

The comfort seat with its additional padding and a seat height increased by 35 mm to 850 mm offers noticeable benefits in seating comfort and therefore even more carefree miles for the rider. Their three colours (black, red and white) also enhances the appearance of the motorcycle.

### 1 Comfort seat



### 2 Comfort rear seat



## CRUISE CONTROL RETROFIT SET (NOT SHOWN)

### Available for:

- S 1000 R
- S 1000 RR

Only available for model codes 0D02, 0D12, 0D10, 0D21

The electronic cruise control can be activated from 30 km/h and keeps the riding speed constant. This makes it possible to enjoy longer motorway stretches in a relaxed style. The function is deactivated on braking, and the selected speed is automatically adopted after activating the Resume button.

## PRO GEAR-SHIFT ASSIST (NOT SHOWN)

### Available for:

- S 1000 R
- S 1000 RR

Not available for model codes 0507, 0517, 0524, 0534

The shift assistant Pro allows shifting up and down in almost all load ranges and engine speed ranges without clutch control. The assistant thus ensures noticeably reduced shifting times, a relief of the clutch hand and thus greater comfort and dynamics.

To be fitted and/or enabled in a specialist workshop, ideally at your authorised BMW Motorrad Retailer.

## HEATED GRIPS AND SWITCHES (NOT SHOWN)

### Heated grips available for:

- S 1000 RR
- HP 4

Only available for model codes 0524, 0534, 0D01, 0D11

### Grip heating for vehicles with and without cruise control, available for:

- S 1000 R
- S 1000 RR

Not available for model codes 0507, 0517, 0524, 0534

Keep your hands as warm as you like with retrofittable heated grips.

To be fitted and/or enabled in a specialist workshop, ideally at your authorised BMW Motorrad Retailer.

## PRO RIDING MODES RETROFIT SET (NOT SHOWN)

### Available for:

- S 1000 RR

Not available for model codes 0507, 0517, 0524, 0534

The Pro riding modes can be retrofitted using an activation code. Riders without Pro riding modes therefore do not have to do without modern safety features. Pro riding modes including dynamic traction control (DTC) or Pro riding modes including ABS Pro suitable for cornering can be retrofitted.

To be fitted and/or enabled in a specialist workshop, ideally at your authorised BMW Motorrad Retailer.



# NAVIGATION & COMMUNICATION

## BMW MOTORRAD NAVIGATOR VI (INCL. 4-BUTTON CRADLE MOUNT)

**Available for:**  
• S 1000 R

With the multifunctional Navigator VI, route planning becomes child's play. The system with 16GB flash memory and a five-inch touch screen always shows the right way, and the waterproof display is easy to read even in direct sunlight. The high-resolution screen provides all the essential information and ensures that you can see the big picture required in every situation. Numerous additional functions make planning and touring an exciting experience. Plan your routes can be created according to your personal preferences and enjoy driving on winding and quiet side roads. In unknown terrain, the "round trip" option is a good choice as it reliably guides the rider at the end of the tour back to the starting point. The Bluetooth connection to the BMW Motorrad communication system and the optional Smartphone Link app enable multimedia on the go: navigation announcements, telephone calls and music streaming as well as the retrieval of weather forecasts or traffic jam information are no problem. Operation is via the stable Mount Cradle; the four buttons can also be accurately controlled while wearing gloves. Choose the pre-installed map data, and you will always be up to date thanks to lifelong, free map updates.



Please note the specifications for different countries.  
Only in combination with bracket for BMW Motorrad navigation devices.

## BMW MOTORRAD SMARTPHONE CRADLE

**Available for:**  
• S 1000 R

BMW Motorrad's robust smartphone cradle provides a safe and protected place for your smartphone. This means that useful functions such as navigation information and online information can also be used while you are on the move. Thanks to the handy charging function, your smartphone is also always ready for action on extended bike tours.



Only in combination with bracket for BMW Motorrad navigation devices.

## BRACKET FOR BMW MOTORRAD NAVIGATION SYSTEMS (NOT SHOWN)

**Available for:**  
• S 1000 R

The BMW Motorrad navigation device holder is mounted on the handlebar clamping block in the rider's field of view.

To be fitted and/or enabled in a specialist workshop, ideally at your authorised BMW Motorrad Retailer.

# SAFETY

## ANTI-THEFT ALARM RETROFIT SET (NOT SHOWN)

**Available for:**  
• S 1000 RR  
• HP 4

Not available for model codes OD10, OD21, OD50, OD60

If the anti-theft alarm system is moved or struck violently, the system responds with a clearly audible signal and a hazard warning indicator lamp.

Note the differences in national-market versions.  
To be fitted and/or enabled in a specialist workshop, ideally at your authorised BMW Motorrad Retailer.

## HIGHER-CAPACITY BATTERY (12V/10AH) (NOT SHOWN)

**Available for:**  
• S 1000 R  
• S 1000 RR  
• HP 4

The higher-capacity battery (12V/10Ah) with maintenance-free AGM technology has a significantly longer service life than conventional lead acid batteries.

## ACTIVATION CODE FOR DTC (NOT SHOWN)

**Available for:**  
• S 1000 R  
• S 1000 RR

Only available for model codes OD02, OD12, OD10, OD21

Dynamic Traction Control (DTC) ensures greater riding stability and controls wheel slip even when leaning into corners to prevent the rear wheel from spinning. Depending on the riding mode, DTC allows more or less slip and thus guarantees the maximum safety and riding dynamics on different routes.

To be fitted and/or enabled in a specialist workshop, ideally at your authorised BMW Motorrad Retailer.

## ABS PRO RETROFIT SET (NOT SHOWN)

**Available for:**  
• S 1000 R  
• S 1000 RR  
• HP 4

Only available for model codes OD02, OD12, OD10, OD21, OD01, OD11

The BMW Motorrad ABS Pro is available in all riding modes and also adapts the ABS control to the motorcycle's lean angle. The system is perfectly adapted to the selected riding mode and ensures optimum braking performance even in bends. The motorcycle does not right itself and remains on course.

To be fitted and/or enabled in a specialist workshop, ideally at your authorised BMW Motorrad Retailer.



BMW Motorrad equipment is available from your authorised BMW Motorrad Retailer.





**BMW  
MOTORRAD**

## **CONNECT TO YOUR BIKE AND THE WORLD AROUND YOU: THE COMMUNICATION SYSTEM FIT-FOR-ALL**

Talk to each other, listen to music and always stay on course. With the BMW Motorrad Fit-for-All communication system, you have everything in your ear and always fully under control via the intuitive, three-button controller. You'll enjoy the impressive audio quality, and thanks to its slim design it can be easily integrated into almost any helmet. Discover more at [bmw-motorrad.com/fit-for-all](https://www.bmw-motorrad.com/fit-for-all)



**MAKE LIFE A RIDE**



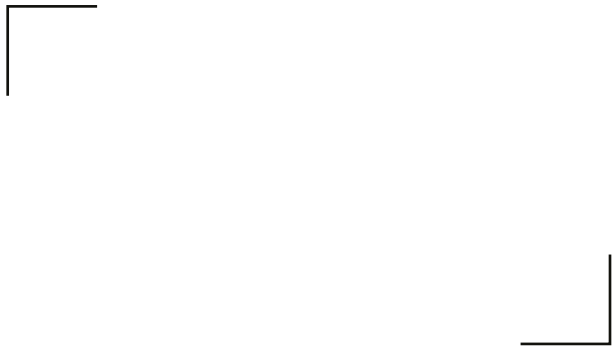

Subject to change in design and equipment. Subject to error. Vehicle illustrations may feature unspecified optional equipment. © BMW Motorrad, EX-VB-1, Munich, Germany. Not to be reproduced, wholly or in part, without the written permission of BMW AG, Munich. Printed on 100% chlorine-free bleached paper. Printed in Germany 01/2020.  
0 11 999 006 20 1 2020