



**BMW Motorrad**



**ORIGINAL  
BMW MOTORRAD  
ACCESSORIES CATALOGUE**

**MAKE LIFE A RIDE.**



# 2018

Original BMW Motorrad  
accessories catalogue

**International GS Trophy** ————— 04

**Current models**

Heritage ————— 06

Sport ————— 26

Urban Mobility ————— 48

Tour ————— 72

Roadster ————— 130

Adventure ————— 168

**Model-independent accessories** ————— 244

**Predecessor models** ————— 256



# THE GS TROPHY: THE ULTIMATE TEST OF MAN, MACHINE AND ACCESSORIES.

It is a test of strength for man and machine. It involves mud, sand, rough terrain, steep ramps and magnificent nature: BMW Motorrad's GS Trophy. A very special adventure with extreme challenges. Teams from all over the world compete here for the tour of a lifetime.

Only those who can place full trust in their machine and all its components can pass this test. That is why all GS Trophy bikes are equipped exclusively with original BMW Motorrad accessories. These accessories are perfectly developed for every bike and for use under the toughest conditions. This is the only way they can withstand the extreme challenges of the GS Trophy and reliably protect man and machine.

For example, the lightweight yet ultra-stable engine protection bar, which, in combination with cylinder head bonnet protection and Enduro aluminium engine protection, reliably protects the engine from damage in the event of a crash or contact with rocky surfaces. The right ergonomics for the driver are also very important. The adjustable driver footrests in combination with the adjustable gear and footbrake levers, among other things make sure that this works for every driving situation and conveys safety.

Well-equipped for the next GS Trophy – a motorcycle adventure in which every participant has to prove himself or herself. And who knows where the tour of your life will take you.



## GET ON YOUR BIKE. OFF ON AN ADVENTURE.



### ORIGINAL BMW MOTORRAD ACCESSORIES THE GS TROPHY BIKES

- Engine protection bar
- Cylinder head cover guard
- Aluminium Enduro engine guard
- Adjustable rider foot pegs
- Adjustable footbrake lever
- Adjustable gear lever
- Stainless steel luggage grid
- Bag for pillion seat
- Headlight guard
- First-aid kit, large
- Advantec oil

### READY FOR ANY CHALLENGE.

No matter where you and your BMW are going: With the right BMW Motorrad accessories, you are always making the right choice. As only things that prove themselves under the toughest conditions meet our idea of quality and are allowed to be used in the GS Trophy – and ultimately make their way into this catalogue. Ready to leave familiar paths and discover new territory.



As well as the many original BMW Motorrad accessories used during the GS Trophy, you will also find numerous other original accessories for the areas of storage space, design and safety in this catalogue. For all current and many older BMW Motorrad models. For a short day trip, the race track or a big tour.

**BE  
IMPATIENT  
TO GET OUT  
AND GET  
ON IT.**

**R nineT derivatives** ————— 06

R nineT, R nineT Pure, R nineT Scrambler,  
R nineT Racer and R nineT Urban G/S



## EQUIPMENT FOR BMW R NINET DERIVATIVES



## HP PARTS



### HP SPORT SILENCER

#### AVAILABLE FOR

R nineT  
R nineT Pure  
R nineT Scrambler  
R nineT Racer  
R nineT Urban G/S

A top-class feature: made entirely of titanium, with a carbon end cap and a laser-etched HP logo. High-quality sounds turns every ride into a thrilling experience. Choose from two positions and in two colour variants (Titanium and Black). Mounting instructions are available from your BMW Motorrad dealership.

Variants without pillion frame are only for solo riding; for aesthetic reasons we recommend combining this item with the main frame screw cover (because the pillion frame is not fitted).

#### PART NUMBERS

**HP sports silencer** (image 1)  
Order number: 77 11 8 564 693\*

Low, with pillion frame  
(+) Short crossover pipe (image 2)  
Order number: 77 11 8 356 747\*

Low, without pillion frame  
(+) Short crossover pipe (image 2)  
Order number: 77 11 8 356 747\*

(+) Silencer bracket  
Order number: 18 21 8 564 071\*

(+) Spacer sleeve for attaching silencer  
Order number: 18 51 7 708 081\*

(+) Rubber decoupling element for silencer  
Order number: 18 51 7 728 002\*

(+) Cylinder screw M8x30  
Order number: 07 12 9 907 381\*

High, without pillion frame (image 3):  
(+) Long crossover pipe  
Order number: 77 11 8 564 716\*

(+) Silencer bracket  
Order number: 77 11 8 359 976\*

HP sports silencer, black (not shown)  
Order number: 77 11 2 455 702

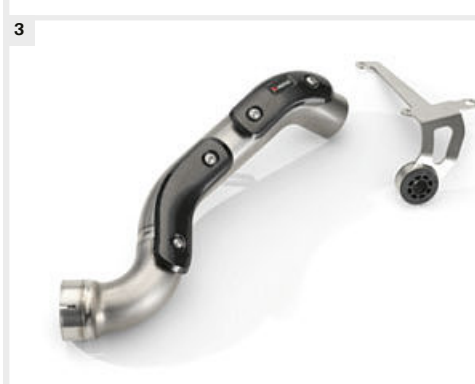

### HP STEERING DAMPER, ADJUSTABLE

#### AVAILABLE FOR

R nineT

Comfort and performance in equal measure. 12 settings to choose from.

To be fitted in a specialist workshop, and ideally at your BMW Motorrad dealership.

For more detailed information, contact your BMW Motorrad dealership or go online at [bmw-motorrad.com](http://bmw-motorrad.com).

#### ITEM NUMBERS

**HP steering damper, adjustable**  
Order number: 77 24 8 394 218\*

### HP CARBON BOLT-ON PARTS

#### AVAILABLE FOR

R nineT  
R nineT Pure  
R nineT Scrambler  
R nineT Racer  
R nineT Urban G/S

Superlative performance is a given with these HP parts. They're elegant, exclusive and durable – each one a masterpiece in its own right. And if perfection's what you're after, you've hit the jackpot. They're made of carbon, the ultimate lightweight material. An unbeatable combination of stylish looks and technical expertise. To be fitted in a specialist workshop, and ideally at your BMW Motorrad dealership.

#### PART NUMBERS

**HP carbon mudguard, front** (image 1)  
Order number: 77 31 8 562 589\*  
Not available for the BMW R nineT.

**HP carbon mudguard, front** (not shown)  
Order number: 77 31 8 562 589\*  
For the BMW R nineT.

**HP carbon belt cover** (image 2)  
Order number: 71 60 7 709 611\*

**HP carbon cylinder head covers** (image 3)  
Order number: 77 12 8 394 184\*  
For more detailed information, contact your BMW Motorrad dealership or go online at [bmw-motorrad.com](http://bmw-motorrad.com).

**HP carbon cover for intake snorkel**  
(image 4)

Order number: 77 31 8 562 580\*  
Mounting instructions are available from your BMW Motorrad dealership.

(+) Plastic washer M5 (two required)

**HP carbon trim for throttle body**  
(image 5)

Order number: 77 31 8 562 584\*  
Mounting instructions are available from your BMW Motorrad dealership.

(+) Plastic washer M5 (two required)

**HP carbon cover for ignition switch/steering lock**  
(image 6)

Order number: 77 31 8 562 583\*  
Mounting instructions are available from your BMW Motorrad dealership.

**HP carbon seat hump cover** (image 7)  
Order number: 77 34 8 396 070\*

(+) Padding for seat hump  
Order number: 77 34 8 533 901\*

**(o) Custom padding for seat hump** (image 8)  
Order number: 77 34 8 564 531\*

Mounting instructions are available from your BMW Motorrad dealership.

For solo riding only.

Recommended if pillion seat is not fitted.

The rear bag, seat hump cover and pillion comfort seat cannot be combined.

Not available for the BMW R nineT Scrambler or Urban G/S.

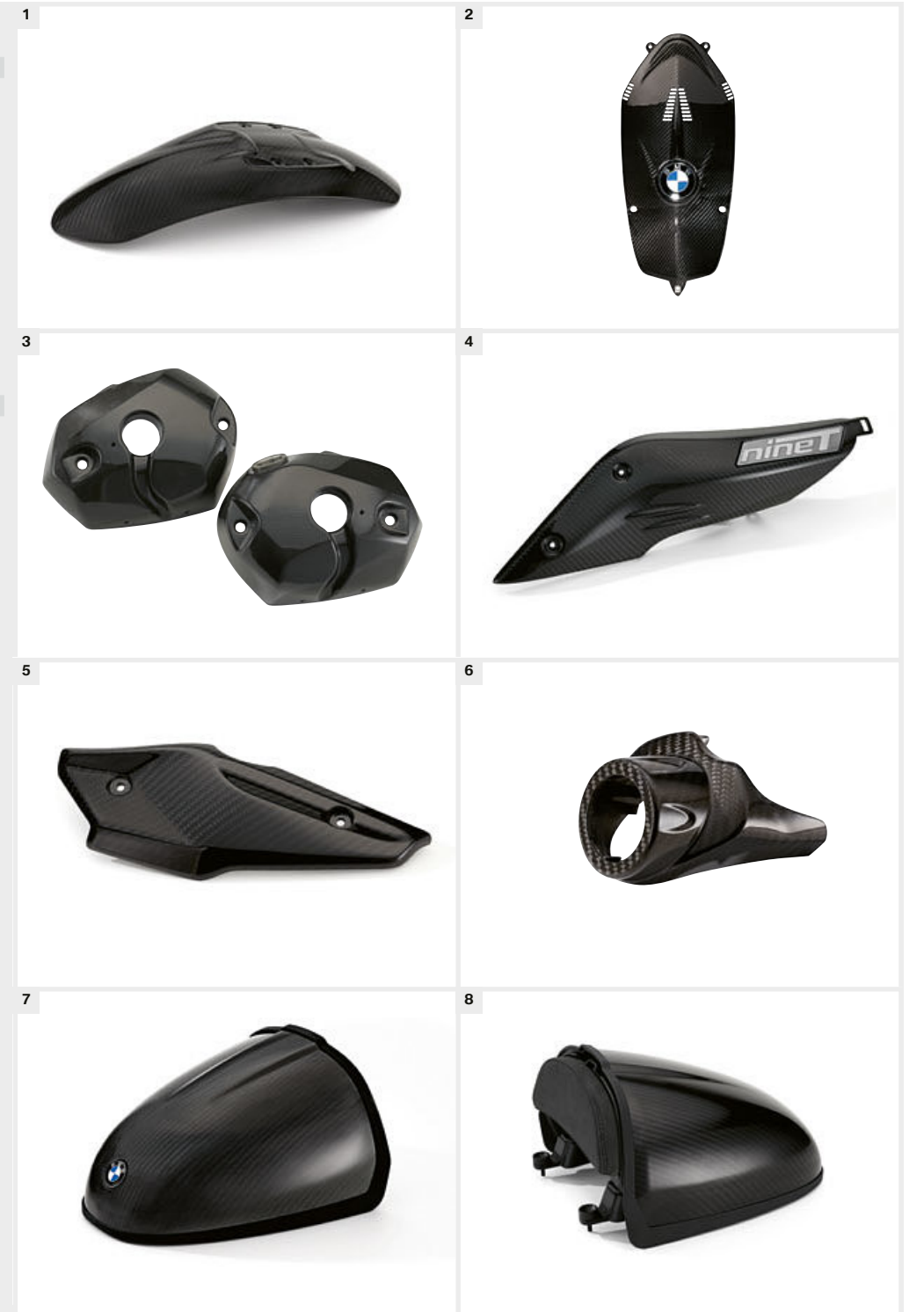

## STORAGE

### LUGGAGE RACK

#### AVAILABLE FOR

R nineT  
R nineT Pure  
R nineT Scrambler  
R nineT Racer  
R nineT Urban G/S

Ideal for riders who enjoy travelling solo with lots of luggage.

For solo riding only.

Only available in conjunction with the single seat for luggage rack.

Mounting instructions are available from your BMW Motorrad dealership.

Not available in conjunction with the rear bag.

#### PART NUMBER

**Luggage rack**  
Order number: 77 44 8 394 221\*



### TANK BAG/ TANK BAG, LEATHER EDITION

#### AVAILABLE FOR

R nineT  
R nineT Pure  
R nineT Scrambler  
R nineT Racer  
R nineT Urban G/S

Practical and stylish in one – the waterproof canvas tank bag provides 11 l of storage space. Available in two material/colour variants.

#### ITEM NUMBERS

Tank bag, 11l (image 1)  
Order number: 77 45 2 451 057\*  
(o) **Tank bag, leather edition, 11l** (image 2)  
Order number: 77 45 2 451 074\*  
(+) Tank strap (image 1)  
Order number: 77 45 2 451 071\*  
(o) **Tank strap, leather edition** (image 2)  
Order number: 77 45 2 451 072\*

### SMALL TANK BAG/ SMALL TANK BAG, LEATHER EDITION

#### AVAILABLE FOR

R nineT  
R nineT Pure  
R nineT Scrambler  
R nineT Racer  
R nineT Urban G/S

Stylish and compact canvas bag for carrying a smartphone and sunglasses. Available in two material/colour combinations.

#### PART NUMBERS

**Small tank bag, 1.5l** (image 1)  
Order number: 77 45 2 451 066\*  
(o) **Small tank bag, leather edition, 1.5l** (image 2)  
Order number: 77 45 2 451 068\*  
(+) **Tank strap** (image 1)  
Order number: 77 45 2 451 071\*  
(o) **Tank strap, leather edition** (image 2)  
Order number: 77 45 2 451 072\*

(+) = "and" – this item must be ordered at the same time  
(o) = "or" – this item may be ordered as an alternative option



### REAR BAG/REAR BAG, LEATHER EDITION

#### AVAILABLE FOR

R nineT  
R nineT Pure  
R nineT Scrambler  
R nineT Racer  
R nineT Urban G/S

Planning a trip? The waterproof rear bag is made of canvas and offers a full 40l of storage space – bags of room for all the essentials. Available in two material/colour combinations.

For solo riding only.

Not available in conjunction with a luggage rack.

The rear bag, seat hump cover and pillion comfort seat cannot be combined.

Not for use when Scrambler single seat or pillion comfort seat is fitted.

Rear bag cannot be combined with side bag(s).

#### ITEM NUMBERS

**Rear bag, 40l** (image 1)  
Order number: 77 49 8 545 097\*  
**Rear bag, leather edition, 40l** (image 2)  
Order number: 77 49 2 451 076\*

\* Original BMW Motorrad equipment is available from your BMW Motorrad dealer.

### SIDE BAGS/SIDE BAGS, LEATHER EDITION

#### AVAILABLE FOR

R nineT  
R nineT Pure  
R nineT Scrambler  
R nineT Racer  
R nineT Urban G/S

The side bags with a removable, waterproof liner combine classic design with modern fastening technology. With a total volume of 23l, they provide plenty of space for long trips and everyday riding. Available in two material/colour combinations.

Rear bag cannot be combined with side bag(s).

Left side bag can only be fitted with a silencer in the low position.

#### PART NUMBERS

**Right side bag, 14l** (image 1)  
Order number: 77 40 2 451 048\*  
(o) **Right side bag, leather edition, 14l** (image 2)  
Order number: 77 40 2 451 060\*  
(+) Bracket for right side bag  
Order number: 77 40 2 451 054\*  
Mounting instructions are available from your BMW Motorrad dealership.  
**Left side bag, 9l** (image 3)  
Order number: 77 40 2 451 052\*  
(o) **Left side bag, leather edition, 9l** (image 4)  
Order number: 77 40 2 451 059\*  
(+) Bracket for right side bag  
Order number: 77 40 2 451 055\*  
Mounting instructions are available from your BMW Motorrad dealership.



# DESIGN

## BMW MOTORRAD MACHINED PARTS

### AVAILABLE FOR

R nineT  
R nineT Pure  
R nineT Scrambler  
R nineT Racer

Each unique, lovingly crafted BMW Motorrad Machined Part is designed to make the BMW R nineT even more stunning. The designs are the result of close collaboration with Roland Sands, the Californian designer, trendsetter and customization expert. All BMW Motorrad Machined Parts also feature the "by Roland Sands Design" signature logo. The high-quality surfaces of these aluminium parts boast bold contrasts in Glossy Black and are produced in a series of complex processing steps, some of which are performed manually. All BMW Motorrad Machined Parts can be combined with the full range of Original BMW Motorcycle Equipment, allowing you to transform the BMW R nineT into your own ultra-personalized ride.

### ITEM NUMBERS

**Machined cylinder head covers** (image 1)  
Order number: 77 12 2 448 369\*  
To be fitted in a specialist workshop, and ideally at your BMW Motorrad dealership.

**Machined headlight cover** (image 2)  
Order number: 77 25 2 447 776\*  
Not available for the BMW R nineT Racer or Urban G/S.  
To be fitted in a specialist workshop, and ideally at your BMW Motorrad dealership.

**Machined belt cover** (image 3)  
Order number: 77 12 2 447 717\*  
To be fitted in a specialist workshop, and ideally at your BMW Motorrad dealership.

**Machined oil filler cap** (image 4)  
Order number: 77 12 2 447 778\*

**Machined handlebar end covers** (image 5)  
Order number: 77 25 2 447 775\*

**Machined rear axle cover** (image 6)  
Order number: 77 25 2 446 856\*

**Machined cover for angular gearbox mount** (image 7)  
Order number: 77 25 2 447 708\*

**Machined swing-arm bearing cover** (image 8)  
Order number: 77 25 2 447 694\*



### MILLED FOOTREST SYSTEM

#### AVAILABLE FOR

R nineT  
R nineT Pure  
R nineT Scrambler  
R nineT Urban G/S

CNC-milled foot pegs combine aesthetic appeal with exceptional functionality. A wide range of adjustment options offer riders everything they need when it comes to ergonomics and track-style riding. Not available for the BMW R nineT Racer.  
To be fitted and/or enabled in a specialist workshop, and ideally at your BMW Motorrad dealership.

#### PART NUMBERS

**Milled rider foot peg, left**  
Order number: 77 25 8 394 587\*

(+) Milled rider foot peg, right  
Order number: 77 25 8 394 588\*

(+) Micro switch  
Order number: 61 32 7 683 117\*

**Milled pillion passenger foot pegs**  
Order number: 77 25 8 358 688\*

**Milled pillion passenger foot pegs, black** (not shown)  
Order number: 77 25 2 452 955\*  
Mounting instructions are available from your BMW Motorrad dealership.



### MILLED HAND LEVER

#### AVAILABLE FOR

R nineT  
R nineT Pure  
R nineT Scrambler  
R nineT Racer  
R nineT Urban G/S

The CNC-milled HP hand levers made from corrosion-resistant, anodized aluminium are adjustable via a screw mechanism. Mounting instructions are available from your BMW Motorrad dealership.

#### PART NUMBERS

**Milled brake lever**  
Order number: 77 22 8 355 204\*

(+) Milled clutch lever  
Order number: 77 22 8 355 203\*



### R NINET SILENCER

#### AVAILABLE FOR

R nineT Pure  
R nineT Urban G/S

An eye-catching addition: the high-position dual silencer on the R nineT is retrofittable on all other vintage models. To be fitted and/or enabled in a specialist workshop, and ideally at your BMW Motorrad dealership.

#### PART NUMBER

**R nineT silencer**  
For solo riding only.  
Only available in conjunction with either the standard silencer (except Scrambler), the silencer R nineT or the HP sport silencer (low).  
Required if no pillion frame is fitted.  
For aesthetic reasons we recommend combining this item with the main frame screw cover (because the pillion frame is not fitted).

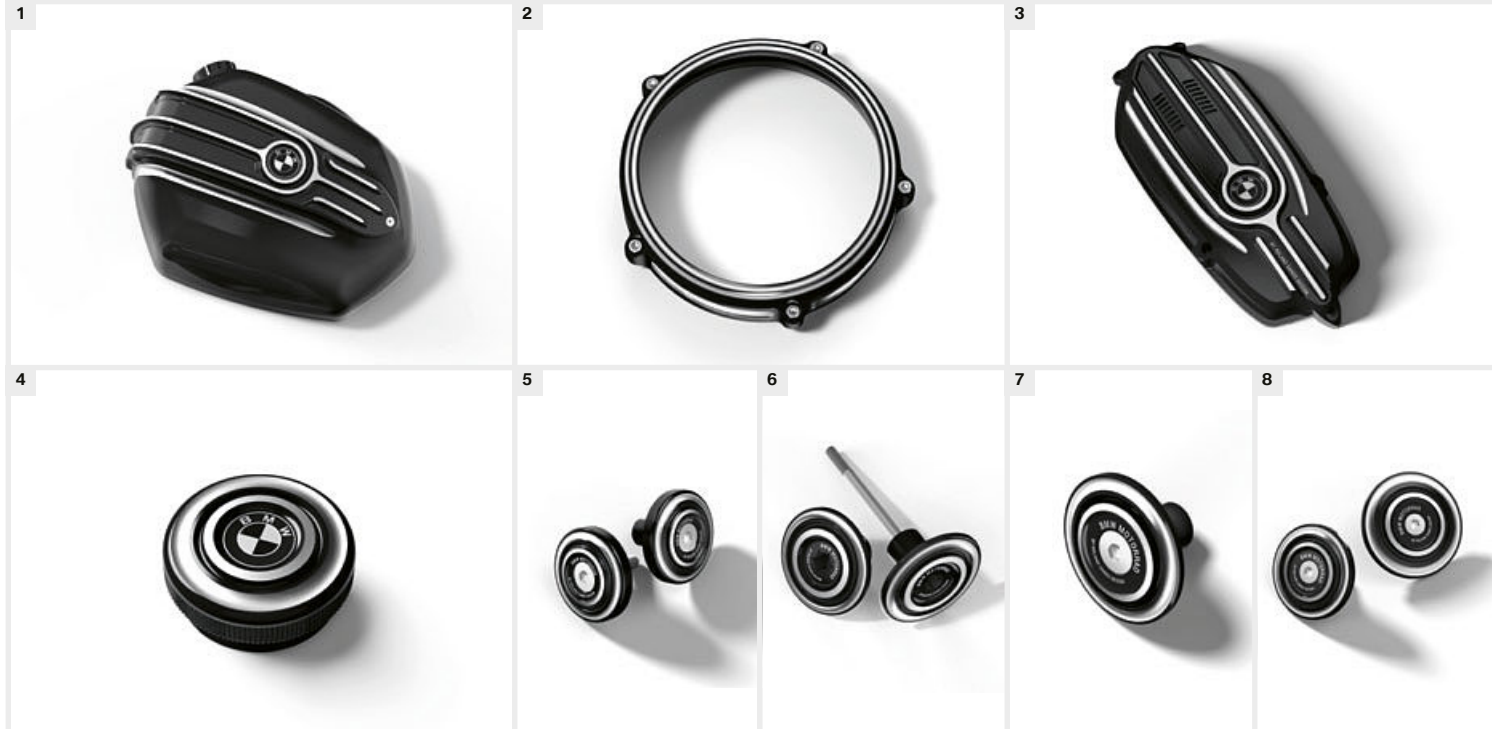

(+) = "and" – this item must be ordered at the same time  
(o) = "or" – this item may be ordered as an alternative option

### REV COUNTER INCL. ON-BOARD COMPUTER

#### AVAILABLE FOR

R nineT  
R nineT Pure  
R nineT Scrambler  
R nineT Racer

Stay up to date with the rev counter plus gear indicator and on-board computer.  
To be fitted and/or enabled in a specialist workshop, and ideally at your BMW Motorrad dealership.

#### PART NUMBERS

**Rev counter incl. on-board computer**  
Order number: 62 11 8 564 506\*

(+) Bracket for twin instrument cluster, Matt Chrome-plated  
Order number: 77 53 8 389 482\*

(o) Bracket for twin instrument cluster, Black  
Order number: 77 53 8 389 483\*





### BMW MOTORRAD ALUMINIUM PARTS

#### AVAILABLE FOR

R nineT  
R nineT Pure  
R nineT Scrambler  
R nineT Racer  
R nineT Urban G/S

These high-quality aluminium parts lend each motorcycle its own distinctive look. Every part is guaranteed to turn heads.

Mounting instructions are available from your BMW Motorrad dealership.



#### PART NUMBERS

##### Hand-brushed aluminium windshield (image 1)

Order number: 77 33 8 559 576\*

Available for the BMW R nineT, Pure and Scrambler

Mounting instructions are available from your BMW Motorrad dealership.

(+) Windshield bracket

Order number: 77 33 8 564 916\*

(+) Mounting parts

Order number: 77 33 8 394 186\*

Scheduled availability from the end of the third quarter of 2017.

##### Hand-brushed aluminium radiator trim, left (image 3)

Order number: 77 12 8 564 925

Mounting instructions are available from your BMW Motorrad dealership.

(+) Hand-brushed aluminium radiator trim, right

Order number: 77 12 8 564 926\*

Mounting instructions are available from your BMW Motorrad dealership.

(+) Cylinder screw M6x16 (two required)

Order number: 7 12 9 907 403

##### Hand-brushed aluminium triangular frame cover (not shown)

Order number: 77 31 8 394 222\*

Mounting instructions are available from your BMW Motorrad dealership.

##### Hand-brushed aluminium seat hump cover (image 3)

Order number: 77 34 8 396 069\*

Available for the BMW R nineT, Pure and Scrambler

(o) Aluminium seat hump cover (image 2)

For more detailed information, contact your BMW Motorrad dealership or go online at [bmw-motorrad.com](http://bmw-motorrad.com).

(+) Padding for seat hump

Order number: 77 34 8 533 901\*

(o) Padding for Alcantara seat hump

Order number: 77 34 8 564 531\*

Mounting instructions are available from your BMW Motorrad dealership.

For solo riding only

The rear bag, seat hump cover and pillion comfort seat cannot be combined.

Not available for the BMW R nineT Scrambler or Urban G/S.



### 2V-STYLE CYLINDER HEAD COVERS

#### AVAILABLE FOR

R nineT  
R nineT Pure  
R nineT Scrambler  
R nineT Racer  
R nineT Urban G/S

These retro-style cylinder head covers for your boxer engine are truly a stylish blast from the past.

To be fitted and/or enabled in a specialist workshop, and ideally at your BMW Motorrad dealership.

#### PART NUMBERS

##### 2V-style cylinder head cover, left

Order number: 77 12 8 394 395\*

(+) 2V-style cylinder head cover, right

Order number: 77 12 8 394 396\*

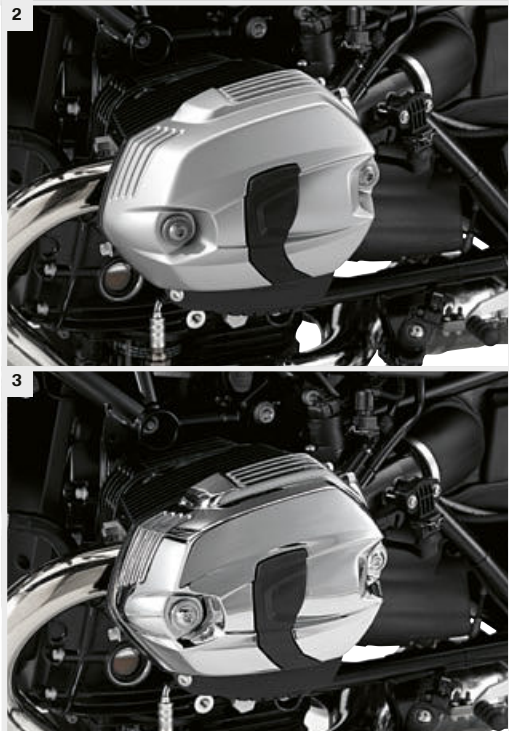

### HAND-BRUSHED ALUMINIUM TANK

#### AVAILABLE FOR

R nineT  
R nineT Pure  
R nineT Scrambler  
R nineT Racer  
R nineT Urban G/S

The aluminium tank is manufactured in accordance with BMW quality standards, and hand-brushed to create its distinctive surface. This makes each tank completely unique.

To be fitted and/or enabled in a specialist workshop, and ideally at your BMW Motorrad dealership.

#### ITEM NUMBERS

##### Hand-brushed aluminium tank, with visible seam (image 1)

Order number: 16 11 8 565 075\*

##### (o) Hand-brushed aluminium tank, with smooth seam (image 2)

Order number: 16 11 8 565 077\*

(+) BMW badge (two required)

Order number: 51 14 7 721 223\*

(+) Insulating foil

Order number: 16 11 8 543 475\*

### CYLINDER HEAD COVERS IN SILVER, BLACK OR CHROME

#### AVAILABLE FOR

R nineT  
R nineT Pure  
R nineT Scrambler  
R nineT Racer

Different colours provide even more ways to personalize your BMW. Whichever you choose, these variants in Black, Silver and Chrome will give your motorcycle that extra-special something.

To be fitted and/or enabled in a specialist workshop, and ideally at your BMW Motorrad dealership.

#### PART NUMBERS

##### Black cylinder head cover, left (image 1)

Order number: 77 12 8 564 985\*

(+) Black cylinder head cover, right

Order number: 77 12 8 564 986\*

##### Silver cylinder head cover, left (image 2)

Order number: 11 12 7 723 233\*

(+) Silver cylinder head cover, right

Order number: 11 12 7 723 234\*

##### Chrome cylinder head cover (image 3)

Order number: 77 12 8 394 185\*

Not available for the BMW R nineT Urban G/S

For more detailed information, contact your BMW Motorrad dealership or go online at [bmw-motorrad.com](http://bmw-motorrad.com).

### GRANITE GREY IGNITION SWITCH/STEERING LOCK COVER (NOT SHOWN)

#### AVAILABLE FOR

R nineT  
R nineT Pure  
R nineT Scrambler  
R nineT Racer  
R nineT Urban G/S

Make your mark – the Granite Grey ignition switch/steering lock cover creates a striking visual contrast.

Mounting instructions are available from your BMW Motorrad dealership.

#### PART NUMBER

##### Ignition switch/steering lock cover, Granite Grey

Order number: 77 31 8 558 012\*





### SCRAMBLER SILENCER

#### AVAILABLE FOR

R nineT  
R nineT Pure  
R nineT Scrambler  
R nineT Racer

Unmistakable at first glance: the Scrambler's high-position dual silencer is also available for all other vintage models.

Only available in conjunction with the BMW R nineT Scrambler pillion frame or with a Scrambler silencer bracket (without pillion frame).

To be fitted and/or enabled in a specialist workshop, and ideally at your BMW Motorrad dealership.

Model shown: BMW R nineT Scrambler.

#### PART NUMBERS

##### Scrambler silencer (not shown)

Order number: 18 51 8 561 336\*

(o) Scrambler silencer, low-noise

Order number: 18 51 8 356 906\*



### BRACKET FOR SCRAMBLER SILENCER

#### AVAILABLE FOR

R nineT  
R nineT Pure  
R nineT Scrambler  
R nineT Racer  
R nineT Urban G/S

Bracket for attaching the Scrambler silencer if no pillion frame is fitted.

For solo riding only.

Mounting instructions are available from your BMW Motorrad dealership.

Required if no pillion frame is fitted.

For aesthetic reasons we recommend combining this item with the main frame screw cover (because the pillion frame is not fitted).

Only in conjunction with the Scrambler silencer.

#### ITEM NUMBERS

##### Bracket for Scrambler silencer

Order number: 77 11 8 358 245



### SILENCER BRACKET

#### AVAILABLE FOR

R nineT  
R nineT Pure

Bracket for attaching the silencer if no pillion frame is fitted.

For solo riding only.

For aesthetic reasons we recommend combining this item with the main frame screw cover (because the pillion frame is not fitted).

Only available in conjunction with either the standard silencer (except Scrambler), the silencer R nineT or the HP sport silencer (low).

Required if no pillion frame is fitted.

#### ITEM NUMBERS

##### Silencer bracket

Order number: 18 21 8 564 071



### CLASSIC EMBLEM

#### AVAILABLE FOR

R nineT Scrambler  
R nineT Urban G/S

Based on the old emblems, the classic version completes the vintage look.

To be fitted and/or enabled in a specialist workshop, and ideally at your BMW Motorrad dealership.

#### PART NUMBERS

##### Classic emblem

Order number: 46 51 8 544 485\*

(+) Grooved pins (two required)

Order number: 07 11 9 908 551\*



### SPOKED WHEELS

#### AVAILABLE FOR

R nineT Racer  
R nineT Pure  
R nineT Urban G/S

Classic spoked wheels round off the vintage look. Not available for the BMW R nineT Scrambler or Urban G/S.

To be fitted and/or enabled in a specialist workshop, and ideally at your BMW Motorrad dealership.

#### ITEM NUMBERS

##### Front spoked wheel, R nineT:

Order number: 36 31 8 562 551\*

(+) Rear spoked wheel, R nineT:

Order number: 36 31 8 569 539\*

(+) Wheel bolt M10x53 (five required)

Order number: 36 31 7 668 389\*



### CROSS-SPOKE WHEELS

#### AVAILABLE FOR

R nineT Racer  
R nineT Scrambler  
R nineT Urban G/S

Black-anodized cross-spoke wheels round off the vintage look.

Not available for the BMW R nineT, Pure or Racer.

To be fitted and/or enabled in a specialist workshop, and ideally at your BMW Motorrad dealership.

#### PART NUMBERS

##### Front spoked wheel (image 1)

Order number: 36 31 8 562 512\*

(+) Rear spoked wheel (image 2)

Order number: 36 31 8 562 513\*

(+) Wheel bolt M10x53 (five required)

Order number: 36 31 7 668 389\*

### HANDLEBAR END COVERS

#### AVAILABLE FOR

R nineT Scrambler  
R nineT Racer  
R nineT Urban G/S

A hands-on highlight: handlebar end covers in Silver. Mounting instructions are available from your BMW Motorrad dealership.

#### PART NUMBERS

##### R nineT handlebar end covers (two required)

Order number: 32 71 8 543 341\*

(+) ISA screw M12 (two required)

Order number: 07 12 9 908 523\*





**SCRAMBLER WINDSHIELD, ALPINE WHITE**

**AVAILABLE FOR**

R nineT  
R nineT Pure  
R nineT Scrambler

Reminiscent of a race number plate; provides protection against oncoming wind. With scratch-resistant coating. Mounting instructions are available from your BMW Motorrad dealership.

Not available for the BMW R nineT Racer or Urban G/S.

**PART NUMBERS**

**Scrambler windshield, Alpine White**

Order number: 77 33 8 559 460\*

(+) Windshield bracket

Order number: 77 33 8 564 916\*

(+) Mounting parts

Order number: 77 33 8 394 187\*

For more detailed information, contact your BMW Motorrad dealership or go online at [bmw-motorrad.com](http://bmw-motorrad.com).



**RACE NUMBER PLATE, ALPINE WHITE**

**AVAILABLE FOR**

R nineT  
R nineT Pure  
R nineT Scrambler  
R nineT Racer  
R nineT Urban G/S

This classic design pays homage to the racing greats. Mounting instructions are available from your BMW Motorrad dealership.

Model shown: BMW R nineT Scrambler.

For more detailed information, contact your BMW Motorrad dealership or go online at [bmw-motorrad.com](http://bmw-motorrad.com).

**PART NUMBERS**

**Race number plate, Alpine White**

Order number: 77 31 8 394 219\*

(o) Race number plate, Alpine White (for HP sport silencer above)

Order number: 77 31 8 394 220\*



**INSTRUMENT CLUSTER HOUSING, MATT CHROME-PLATED**

**AVAILABLE FOR**

R nineT  
R nineT Scrambler  
R nineT Pure  
R nineT Racer

This stylish Matt Chrome-plated housing beautifully frames the instrument cluster. It fits the standard speedometer as well as optional rev counters.

Mounting instructions are available from your BMW Motorrad dealership.

For aesthetic reasons we recommend also replacing the standard speedometer housing (two required).

Fits both standard speedometers and optional rev counters.

**ITEM NUMBERS**

**Instrument cluster housing, Matt Chrome-plated**

Order number: 77 52 8 564 588

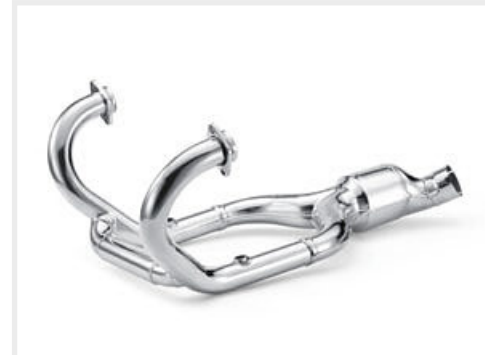

**CHROME-PLATED EXHAUST MANIFOLD**

**AVAILABLE FOR**

R nineT Racer  
R nineT Scrambler  
R nineT Urban G/S

Adds a dash of elegance to the standard silencer or HP sport silencer.

Also available as an equipment option.

To be fitted and/or enabled in a specialist workshop, and ideally at your BMW Motorrad dealership.

**PART NUMBERS**

**Chrome-plated exhaust manifold**

Order number: 18 51 8 561 883



**MAIN FRAME SCREW COVER**

**AVAILABLE FOR**

R nineT  
R nineT Pure  
R nineT Scrambler  
R nineT Racer  
R nineT Urban G/S

If no pillion frame is fitted, these covers conceal exposed screws on the main frame.

For solo riding only.

Mounting instructions are available from your BMW Motorrad dealership.

Recommended if pillion frame is not fitted (one required for lower position, two for higher position).

**PART NUMBER**

**Main frame screw cover**

Order number: 77 25 8 536 857\*



**LED INDICATORS**

**AVAILABLE FOR**

R nineT  
R nineT Pure  
R nineT Scrambler  
R nineT Racer

Cutting-edge design inside and out. The LED indicators deliver reduced energy consumption and significantly longer bulb life – a shining example of efficiency.

To be fitted and/or enabled in a specialist workshop, and ideally at your BMW Motorrad dealership.

**PART NUMBERS**

**LED indicators (four required)**

Order number: 63 13 8 522 499\*



**KNEE PADS**

**AVAILABLE FOR**

R nineT  
R nineT Pure  
R nineT Racer  
R nineT Urban G/S

These ergonomically shaped rubber pads protect both sides of the tank from scratches. And their stylish design underscores the classic look of the BMW R nineT. Mounting instructions are available from your BMW Motorrad dealership.

The previous model is shown here.

**PART NUMBER**

**Knee pads**

Order number: 77 31 8 546 308\*

## ERGONOMICS & COMFORT



### SCRAMBLER SINGLE SEAT, SADDLE BROWN

#### AVAILABLE FOR

R nineT  
R nineT Pure  
R nineT Scrambler  
R nineT Urban G/S

The classic Scrambler single seat gives the vintage models a sporty retro look and is ideal for solo riding. The single seats are all waterproof and finished to the highest quality. The focus of the design is to provide an authentic look and feel, which is why clothing such as dark jeans may stain the seat. Stains of this kind and other discolourations are considered a desirable patina, and do not constitute defects.

Mounting instructions are available from your BMW Motorrad dealership.

For solo riding only.

Not available in conjunction with the rear bag

Not available for the BMW R nineT Racer.

#### PART NUMBERS

##### Scrambler single seat, Saddle Brown

Order number: 77 34 8 564 907\*

(+) Rear section for single seat

Order number: 77 34 8 560 267\*



### SCRAMBLER SEAT, HIGH

The high version of the BMW R nineT Scrambler seat has been specially designed to ensure the optimum knee angle for taller riders. The seat surface is the same as on the standard seat.

The seat is also waterproof and finished to the highest quality. The focus of the design is to provide an authentic look and feel, which is why clothing such as dark jeans may stain the seat. Stains of this kind and other discolourations are considered a desirable patina, and do not constitute defects.

Not available for the BMW R nineT, Pure, Racer or Urban G/S.

#### ITEM NUMBER

##### Scrambler seat, high, Saddle Brown

(seat height: 850 mm; step length: 1,890mm)

Order number: 52 53 8 560 248\*

#### PART NUMBER

##### Pillion comfort seat, Black

Order number: 77 34 8 537 714\*



### SINGLE SEAT FOR LUGGAGE RACK IN RED OR SADDLE BROWN

#### AVAILABLE FOR

R nineT  
R nineT Pure  
R nineT Scrambler  
R nineT Racer  
R nineT Urban G/S

Ideal for riders who enjoy travelling solo with lots of luggage.

The single seats are all waterproof and finished to the highest quality. The focus of the design is to provide an authentic look and feel, which is why clothing such as dark jeans may stain the seat. Stains of this kind and other discolourations are considered a desirable patina, and do not constitute defects.

Mounting instructions are available from your BMW Motorrad dealership.

Only available in conjunction with a luggage rack.

#### PART NUMBERS

##### Single seat for luggage rack, Red

Order number: 77 34 8 564 903\*

(o) Single seat for luggage rack, Saddle Brown

Order number: 77 34 8 388 471\*

(+) Mounting parts for single seat

Order number: 77 34 8 394 189\*



### R NINET RIDER SEAT, BLACK

#### AVAILABLE FOR

R nineT Urban G/S

The BMW R nineT's Black rider and pillion seats give the BMW R nineT Urban G/S a classic look and feel.

Only in conjunction with the BMW R nineT pillion passenger seat or the pillion comfort seat. Model shown: BMW R nineT.

#### PART NUMBER

##### R nineT rider seat, Black

Order number: 52 53 8 531 151



### CUSTOM RIDER SEAT, BLACK

#### AVAILABLE FOR

R nineT  
R nineT Pure  
R nineT Scrambler  
R nineT Racer  
R nineT Urban G/S

The Custom rider seat features a quilted design and Alcantara-style elements for an even more distinctive look.

Only in conjunction with the BMW R nineT pillion passenger seat, pillion comfort seat or seat hump.

#### PART NUMBER

##### Custom rider seat, Black

Order number: 77 34 8 546 218\*



### PILLION COMFORT SEAT, BLACK

#### AVAILABLE FOR

R nineT  
R nineT Pure  
R nineT Racer  
R nineT Urban G/S

The pillion comfort seat matches the overall style of the motorcycle and increases passenger comfort.

The rear bag, seat hump cover and pillion comfort seat cannot be combined.

Only in conjunction with BMW R nineT rider seat or Custom rider seat; cannot be installed if there is no pillion frame.



### HEATED GRIPS

#### AVAILABLE FOR

- R nineT
- R nineT Pure
- R nineT Scrambler
- R nineT Racer
- R nineT Urban G/S

Keep your hands warm in cooler temperatures with heated grips (adjustable between two settings). To be fitted and/or enabled in a specialist workshop, and ideally at your BMW Motorrad dealership.

For more detailed information, contact your BMW Motorrad dealership or go online at [bmw-motorrad.com](http://bmw-motorrad.com).

#### PART NUMBERS

##### Heated grips and switches

Order number: 61 31 8 565 847\*



### ADJUSTABLE CLIP-ON HANDLEBARS

#### AVAILABLE FOR

- R nineT

Clip-ons let you really lean into the front wheel and give your BMW an even more dynamic look. Cannot be used in conjunction with the bracket for BMW Motorrad navigation devices.

To be fitted and/or enabled in a specialist workshop, and ideally at your BMW Motorrad dealership.

For more detailed information, contact your BMW Motorrad dealership or go online at [bmw-motorrad.com](http://bmw-motorrad.com).

#### PART NUMBERS

##### Adjustable clip-on handlebars

Order number: 77 22 8 394 378\*

## NAVIGATION AND COMMUNICATION



### BMW MOTORRAD NAVIGATION SYSTEMS

#### AVAILABLE FOR

- R nineT
- R nineT Pure
- R nineT Scrambler
- R nineT Racer
- R nineT Urban G/S

Where am I? Where do I want to go, and what's the most scenic way to get there? BMW Motorrad navigation devices show you where to go. Made specifically for motorcyclists, they're easy to fit and use – even with gloves on – and come with lifetime map updates.

The new BMW Motorrad Navigator VI is your ticket to the tour of your dreams. A whole new level of adventure awaits thanks to the "winding roads" route option, "avoid motorways" feature and the "round trip" function, which configures journeys based on time, distance or stopover. The circular polarization filter on the display minimizes reflection and improves contrast, ensuring the screen is easy to read, even in direct sunlight.

16 GB of flash storage, and the ability to stream music from your smartphone, are the ultimate luxury.

Thanks to Bluetooth® technology, the sophisticated BMW Motorrad Navigator Street (with easy-to-read 4.3" display) is compatible with the optional BMW Motorrad communication system and comes with a host of handy features.

#### ITEM NUMBERS

**BMW Motorrad Navigator VI with cradle mount** (see image, top right)

Order number: 77 52 8 355 749\*

**BMW Motorrad Navigator VI** (without map data)

Order number: 77 52 8 356 005\*

(+) 4-button cradle mount

Order number: 77 52 8 544 464\*

**BMW Motorrad Navigator VI with cradle mount** (see image, top left)

Order number: 77 52 8 536 089\*

**BMW Motorrad Navigator V** (without map data)

Order number: 77 52 8 536 779\*

(+) 4-button cradle mount

Order number: 77 52 8 544 464\*

**BMW Motorrad Navigator Street**

(see image, bottom right)

Order number: 77 52 8 557 855\*

**BMW Motorrad smartphone cradle**

(see image, bottom left)

Order number: 77 52 8 563 125\*

**Bracket for BMW Motorrad navigation devices**

(no image)

Order number: 77 52 8 552 094\*

**Bracket for BMW Motorrad navigation systems**

**R nineT Racer** (not shown)

Order number: 77 52 8 563 044

Mounting instructions are available from your BMW Motorrad dealership.

(+) Screw M8x30 (two required)

Order number: 77 52 7 724 321\*

**Car mounting kit for Navigator VI** (no image)

Order number: 77 52 8 544 460\*

For more detailed information, contact your BMW Motorrad dealership or go online at [bmw-motorrad.com](http://bmw-motorrad.com).

BMW Motorrad navigation devices and the BMW Motorrad smartphone cradle can only be mounted using the BMW Motorrad navigation device bracket.

# SAFETY



## PLASTIC CYLINDER HEAD COVER GUARD

### AVAILABLE FOR

R nineT  
R nineT Pure  
R nineT Racer  
R nineT Urban G/S

The cylinder head cover guard is made of glass-fibre-reinforced plastic and protects the cylinder head from damage. Mounting instructions are available from your BMW Motorrad dealership.

### PART NUMBER

**Plastic cylinder head cover guard**  
Order number: 71 60 7 719 449\*



## ALUMINIUM CYLINDER HEAD COVER GUARD

### AVAILABLE FOR

R nineT  
R nineT Pure  
R nineT Racer  
R nineT Urban G/S

Made of anodized aluminium, the cylinder head cover guard protects the cylinder head and makes the motorcycle more visually striking. Mounting instructions are available from your BMW Motorrad dealership.

The aluminium cylinder head cover guard cannot be combined with the engine protection bar.

### PART NUMBER

**Aluminium cylinder head cover guard**  
Order number: 77 12 8 357 955\*

## ENGINE PROTECTION BAR (NOT SHOWN)

### AVAILABLE FOR

R nineT  
R nineT Pure  
R nineT Urban G/S

The stainless steel, electropolished engine protection bar provides effective protection for the cylinder without compromising the lean angle. Also combines perfectly with the plastic cylinder head cover guard. Mounting instructions are available from your BMW Motorrad dealership.

The aluminium cylinder head cover guard cannot be combined with the engine protection bar.

For more detailed information, contact your BMW Motorrad dealership or go online at [bmw-motorrad.com](http://bmw-motorrad.com)

### PART NUMBER

**Engine protection bar**  
Order number: 77 14 8 394 379\*



## HAND PROTECTORS

### AVAILABLE FOR

R nineT  
R nineT Pure  
R nineT Urban G/S

For effective protection against wind, rain, low branches and flying stones. Mounting instructions are available from your BMW Motorrad dealership.

For more detailed information, contact your BMW Motorrad dealership or go online at [bmw-motorrad.com](http://bmw-motorrad.com).

### PART NUMBERS

**Left hand protector**  
Order number: 77 32 8 396 075\*  
(+) **Right hand protector**  
Order number: 77 32 8 396 076\*



## LED AUXILIARY HEADLIGHTS

### AVAILABLE FOR

R nineT  
R nineT Pure  
R nineT Racer  
R nineT Urban G/S

The LED auxiliary headlights deliver increased safety when visibility is poor, e.g. in fog, snow and rain. For more detailed information, contact your BMW Motorrad dealership or go online at [bmw-motorrad.com](http://bmw-motorrad.com).

To be fitted and/or enabled in a specialist workshop, and ideally at your BMW Motorrad dealership.

The auxiliary headlights are approved for use as fog lights, and may only be used in poor weather conditions. Country-specific road traffic regulations apply.

### PART NUMBERS

**LED auxiliary headlights (two required)**  
Order number: 77 51 8 393 225\*  
(+) **Bracket for LED auxiliary headlights**  
Order number: 77 51 8 394 190\*



## PROTECTIVE GRILLE FOR HEADLIGHT

### AVAILABLE FOR

R nineT  
R nineT Pure  
R nineT Urban G/S

The protective grille for the headlight is ideal for off-road excursions. For off-road use only (not homologated for road use). Mounting instructions are available from your BMW Motorrad dealership.



### PART NUMBERS

**Protective grille for headlight**  
Order number: 77 51 8 393 225\*

**LEAN INTO  
EVERY CURVE.  
AND COME OUT  
WITH EVEN MORE  
SPEED.**

S 1000 RR \_\_\_\_\_ 28  
R 1200 RS \_\_\_\_\_ 38



**SPORT**

## EQUIPMENT FOR THE BMW S 1000 RR.



## HP PARTS

### HP SPORT SILENCER (NOT SHOWN)

A top-class feature for top quality sound. The perfect finish: a 100% titanium silencer with a carbon end-cap and heat shield plus laser-engraved HP logo. High-quality sounds turns every ride into a thrilling experience. Mounting instructions are available from your BMW Motorrad dealership.

#### PART NUMBER

##### HP sport silencer

Order number: 77 11 8 526 079\*



### HP RIDER FOOT PEGS AND HP PILLION PASSENGER FOOT PEGS

These CNC-milled HP foot pegs combine aesthetic appeal with exceptional functionality. A wide range of adjustment options offer riders everything they need when it comes to ergonomics and track-style riding. To be fitted and/or enabled in a specialist workshop, and ideally at your BMW Motorrad dealership.

#### ITEM NUMBERS

##### HP rider foot peg, left (image 1)

Order number: 77 25 8 550 773\*

(+) HP rider foot peg, right

Order number: 77 25 8 569 048\*

##### HP pillion passenger foot pegs (not shown)

Order number: 77 25 8 358 688\*

##### HP passenger footrest, black (image 2)

Order number: 77 25 2 452 955\*



### PRO GEAR-SHIFT ASSIST

Delivers smooth acceleration without using the clutch lever – 10 times faster than normal gear shifts. To be fitted and/or enabled in a specialist workshop, and ideally at your BMW Motorrad dealership.

#### PART NUMBERS

##### Pro gear-shift assist

Order number: 23 41 8 549 125\*

(+) Enabling code for Pro gear-shift assist

Order number: 13 61 8 545 879\*

(+) Micro switch<sup>1</sup>

Order number: 61 31 8 529 368\*

(+) Lever with intermediate plate<sup>1</sup>

Order number: 32 72 8 556 669\*

<sup>1</sup> Required if cruise control feature is not included.



### FOLDING HP BRAKE AND CLUTCH LEVERS

Made out of corrosion-resistant, anodized aluminium, the CNC-milled HP brake and clutch levers are both stylish and highly practical. Easily adjustable to provide the most suitable position for every rider, the built-in folding design also reduces the risk of bending or breaking in the event of an accident. To be fitted and/or enabled in a specialist workshop, and ideally at your BMW Motorrad dealership.

#### PART NUMBERS

##### Folding HP clutch lever (image 1)

Order number: 77 22 8 537 509\*

##### Folding HP brake lever (image 2)

Order number: 77 22 8 537 510\*



**HP BRAKE LEVER PROTECTOR/HP CLUTCH LEVER PROTECTOR**

These lever guards are essential on the racetrack and show the bike's racing pedigree on public roads.

**PART NUMBERS**

- HP clutch lever protector** (not shown)  
Order number: 77 22 8 537 507\*  
Only available in conjunction with folding HP clutch lever.
- HP brake lever protector**  
Order number: 77 22 8 537 508\*

**HP AXLE PROTECTORS**

These highly abrasion-resistant plastic drop-protection pads for the front and rear axles protect the fork and swing arm from damage. Mounting instructions are available from your BMW Motorrad dealership.

**ITEM NUMBER**

- HP axle protectors** (two required)  
Order number: 77 25 8 356 929\*



**HP ENGINE PROTECTORS**

Aluminium engine protectors with plastic sliders provide additional protection for your engine. To be fitted and/or enabled in a specialist workshop, and ideally at your BMW Motorrad dealership.

**ITEM NUMBERS**

- HP engine protector, left** (image 1)  
Order number: 77 25 8 545 293\*
- (+) **HP engine protector, right** (image 2)  
Order number: 77 25 8 545 292\*



(+) = "and" – this item must be ordered at the same time  
(o) = "or" – this item may be ordered as an alternative option

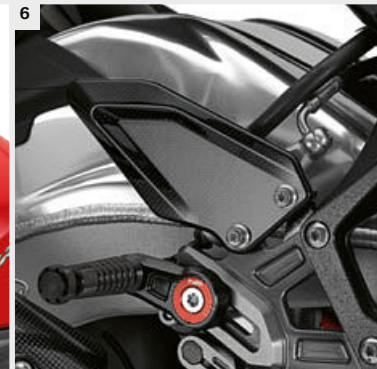
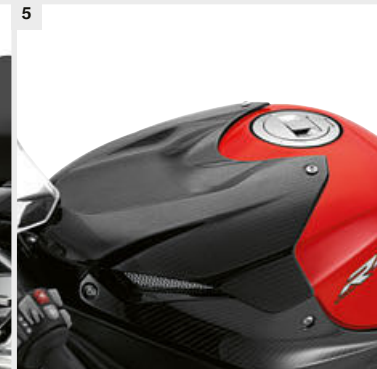

**HP CARBON BOLT-ON PARTS**

Superlative performance is a given with these bolt-on parts. They're elegant, exclusive and durable – each one a masterpiece in its own right. And if perfection's what you're after, you've hit the jackpot here because they're made of carbon, the ultimate lightweight material. An unbeatable combination of stylish looks and technical expertise. Mounting instructions are available from your BMW Motorrad dealership.

**PART NUMBERS**

- HP carbon mudguard, front** (image 1)  
Order number: 77 31 8 549 539\*
- (+) **Body panel screw M5x14** (four required)  
Order number: 46 63 8 534 938\*
- (+) **Plastic washer** (four required)  
Order number: 46 63 7 714 241\*
- HP carbon mudguard, rear** (image 2)  
Order number: 77 31 8 546 482\*
- (+) **Attachment for HP carbon mudguard, rear**  
Order number: 77 31 8 555 696\*
- (+) **Body panel screw M5x25** (three required)  
Order number: 46 63 8 534 939\*
- (+) **Plastic washer** (three required)  
Order number: 46 63 7 714 241\*
- HP carbon upper fairing side panel, left** (image 3)  
Order number: 77 31 8 550 749\*
- (+) **HP carbon upper fairing side panel, right**  
Order number: 77 31 8 550 748\*
- (+) **Body panel screw M5x14** (four required)  
Order number: 46 63 8 534 938\*
- (+) **Plastic washer** (four required)  
Order number: 46 63 7 714 241\*
- HP carbon tank cover, left** (image 4)  
Order number: 77 31 8 550 751\*
- (+) **HP carbon tank cover, right**  
Order number: 77 31 8 550 750\*

- (+) **Body panel screw M5x14** (two required)  
Order number: 46 63 8 534 938\*
- (+) **Body panel screw M5x20** (four required)  
Order number: 46 63 8 527 780\*
- (+) **Plastic washer** (six required)  
Order number: 46 63 7 714 241\*
- HP carbon airbox cover** (image 5)  
Order number: 77 31 8 537 855\*
- (+) **Body panel screw M5x14** (two required)  
Order number: 46 63 8 534 938\*
- (+) **Body panel screw M5x35** (four required)  
Order number: 46 63 8 534 940\*
- (+) **Plastic washer** (six required)  
Order number: 46 63 7 714 241\*
- HP carbon heel protector, left** (image 6)  
Order number: 77 25 8 546 531\*  
To be fitted and/or enabled in a specialist workshop, and ideally at your BMW Motorrad dealership.  
Part of the HP rider foot peg system.
- (+) **HP carbon heel guard, right**  
Order number: 77 25 8 546 530\*
- HP carbon chain guard** (image 7)  
Order number: 71 60 7 714 596\*  
To be fitted and/or enabled in a specialist workshop, and ideally at your BMW Motorrad dealership.
- (+) **Body panel screw M5x14** (two required)  
Order number: 46 63 8 534 938\*
- (+) **Plastic washer** (two required)  
Order number: 46 63 7 714 241\*

\* Original BMW Motorrad equipment is available from your BMW Motorrad dealer.





**USEFUL GEAR FOR THE RACETRACK**

Only for track use (not homologated for road use).

**ITEM NUMBERS**

**HP carbon race engine spoiler** (not shown)

Order number: 77 31 8 551 228\*  
Mounting instructions are available from your BMW Motorrad dealership.

Only available in conjunction with HP power kit.

(+) Body panel screw M5x14 (10 required)  
Order number: 46 63 8 534 938\*

(+) Plastic washer (10 required)  
Order number: 46 63 7 714 241\*

(+) Assembly plug  
Order number: 07 14 7 140 849\*

(+) Tank vent hose (two required)  
Order number: 16 11 7 718 574\*

(+) Fuel line connector (two required)  
Order number: 61 66 1 382 908\*

(+) Rubber grommet (two required)  
Order number: 31 42 1 232 245\*

**HP cover kit** (image 1)  
Order number: 77 31 8 520 178\*

(+) Raised head screw for mirror covers (four required)  
Order number: 46 62 7 652 556\*

(+) Raised head screw M5x30 (three required)  
Order number: 46 54 7 699 778\*

(+) Grommet (three required)  
Order number: 62 21 7 670 749\*

(+) Blind cap set for cable harness  
Order number: 77 53 8 526 536\*

(+) BMW badge  
Order number: 31 42 7 708 518\*

**HP power kit** (image 4)  
For more detailed information, contact your BMW Motorrad dealership or go online at [bmw-motorrad.com](http://bmw-motorrad.com).

To be fitted and/or enabled in a specialist workshop, and ideally at your BMW Motorrad dealership.

For solo riding only.

(+) Cylinder screw M8x35  
Order number: 07 12 9 907 380\*

(+) Cylinder screw M8x30 (two required)  
Order number: 07 12 9 907 381\*

(+) Washer  
Order number: 07 11 9 904 164\*

(+) Hexagonal nut M8  
Order number: 07 11 9 905 374\*

**HP race calibration kit** (image 2)  
Order number: 77 53 8 546 642\*

(+) Data cable with 16-pin connector  
Order number: 77 53 8 388 672\*

(+) Enabling code for HP race calibration kit  
Order number: 13 61 8 542 056\*

**HP data logger** (image 3)  
Order number: 77 53 8 526 204\*

**HP brake pads** (not shown)  
Order number: 77 23 8 535 423\*  
Kit for one brake caliper, two required per vehicle.

**HP brake bleed valve** (image 5)  
Order number: 77 02 8 543 065\*

**HP brake bleed assistant** (not shown)  
Order number: 77 02 8 536 259\*

**HP infrared receiver for lap timer** (image 6)  
Order number: 71 60 7 715 830\*  
Mounting instructions are available from your BMW Motorrad dealership.

(+) HP infrared transmitter for lap timer  
Order number: 71 60 7 715 836



**USEFUL GEAR (ON AND OFF THE TRACK)**



**PART NUMBERS**

**HP handbrake lever with remote adjustment** (image 1)

Order number: 77 22 8 568 167\*  
To be fitted and/or enabled in a specialist workshop, and ideally at your BMW Motorrad dealership.

**HP clutch lever**

Order number: 77 22 8 544 058\*  
Mounting instructions are available from your BMW Motorrad dealership.

**HP seat** (image 3)

Order number: 77 34 8 546 602\*

(+) Mounting kit

Order number: 77 34 8 550 363\*

**HP tyre warmer** (image 2)

Order number: 77 02 8 543 059\*

**Motorcycle rug** (not shown)

Order number: 27 02 2 414 857\*

**HP chain tensioner** (image 4)

Order number: 77 25 8 560 292\*



**HP FORGED WHEELS**

The forged, Black-anodized HP aluminium wheels deliver improved responses and a significant weight reduction (2kg compared to standard wheels). To be fitted and/or enabled in a specialist workshop, and ideally at your BMW Motorrad dealership.

**PART NUMBERS**

**HP forged wheel, front**

Order number: 36 31 8 548 8 92\*

(+) Cylinder screw M8x25 (12 required)  
Order number: 07 12 9 907 382\*

(+) Brake disc (two required)  
Order number: 34 11 8 523 478\*

(+) Sensor ring T=48  
Order number: 34 52 8 523 479\*

(+) ISA screw M5x6 (six required)  
Order number: 07 12 9 907 842\*

**HP forged wheel, rear**

Order number: 36 31 8 548 893\*

(+) Spacing bushing  
Order number: 33 81 8 523 331\*

(+) Camshaft sprocket carrier  
Order number: 33 81 8 530 679\*

(+) Damper (five required)  
Order number: 33 81 8 530 682\*

(+) Camshaft sprocket T=45  
Order number: 33 81 8 532 146\*

(+) Fitting screw M12x1.5 (five required)  
Order number: 33 81 8 532 733\*

(+) Flange nut (five required)  
Order number: 27 71 7 724 142\*

(+) Spacing bushing  
Order number: 36 31 8 534 822\*

## STORAGE



### TANK BAG

The tank bag fits snugly onto the tank. The lockable main compartment is waterproof and has a capacity of 13l. The tank bag has a highly water-resistant map pocket. There's also a small, water-resistant exterior pocket for easy access to small items.

#### PART NUMBER

**Tank bag**  
Order number: 77 45 8 545 898\*



### REAR BAG

The tough, waterproof rear bag is made of easy-care fabric, and its capacity is expandable from 25 to 32 litres. The bag is a perfect match for the design of the BMW S 1000 RR, and can even be used when riding at high speeds.  
For solo riding only.  
Cannot be fitted at the same time as the plastic seat hump cover.

#### PART NUMBER

**Rear bag**  
Order number: 77 49 8 545 894\*

### SADDLE BAGS

Fabric saddle bags with removable, waterproof liners provide 10 l capacity (expandable up to 16 l). Quick-lock design for easy on-and-off before the next tour or race.

#### PART NUMBER

**Saddle bags**  
Order number: 77 40 2 446 914\*



### BAG FOR PILLION SEAT

Compact, sturdy and waterproof, this bag fixes snugly onto the pillion seat and has a 2.5 l capacity (expandable up to 5.5 l).  
Cannot be fitted at the same time as the plastic seat hump cover.

#### PART NUMBER

**Bag for pillion seat**  
Order number: 77 49 8 562 631\*



## DESIGN



### PLASTIC SEAT HUMP COVER IN BIKE COLOUR

Mounted in place of pillion seat. Gives the BMW S 1000 RR an even more dynamic look. Also available ex works.  
For solo riding only.  
Not available in conjunction with the rear bag.

#### PART NUMBERS

**Plastic seat hump cover – Light White**  
Order number: 77 31 8 556 213\*

**Plastic seat hump cover – Racing Red**  
Order number: 77 31 8 556 214\*

**Plastic seat hump cover – Black Storm Metallic**  
Order number: 77 31 8 556 218\*

(+) Attachment for seat hump cover  
Order number: 77 31 8 520 252\*

(+) Locking cylinder (with codes) for central locking with motorcycle  
Order number: 51 25 7 681 200\*  
The locking cylinder for the pillion seat can also be used.

(o) Repair kit for locking cylinder for central locking with motorcycle and/or panniers  
Order number: 51 25 7 698 204\*



### LED INDICATORS

Cutting-edge design inside and out. The LED indicators complement the design of the BMW S 1000 RR perfectly – and thanks to reduced energy consumption and significantly longer bulb life, they're also a shining example of efficiency.  
To be fitted and/or enabled in a specialist workshop, and ideally at your BMW Motorrad dealership.

#### ITEM NUMBERS

**LED indicators** (four required)  
Order number: 63 13 8 522 503\*

(+) Installation kit for LED indicators  
Order number: 77 51 8 551 391\*

## ERGONOMICS & COMFORT

### COMFORT SEAT

Wider than the standard version, the striking padded comfort seat is perfect for longer tours.

#### ITEM NUMBER

**Comfort seat**  
(seat height: 850 mm; step length: 1,870 mm)  
Order number: 77 34 8 544 942\*



### WINDSHIELDS

Want a cool look or better wind protection? Look no further. The tinted version of the standard windshield gives your bike a track-style edge while the high windshield (also available as tinted) deflects oncoming wind more effectively.

Mounting and usage instructions are available from your BMW Motorrad dealership.



#### PART NUMBERS

**Tinted windshield** (image 1)  
Order number: 46 63 8 540 846\*

**High windshield, clear** (image 2)  
Order number: 77 33 8 550 074\*

**High windshield, tinted** (image 3)  
Order number: 77 33 8 550 075\*



### PILLION COMFORT SEAT

The pillion comfort seat is padded and wider than the standard version, and significantly increases passenger comfort.

#### PART NUMBERS

**Pillion comfort seat**  
Order number: 77 34 8 549 541\*

(+) Locking cylinder (with codes) for central locking with motorcycle  
Order number: 51 25 7 681 200\*  
The locking cylinder for the pillion seat can also be used.

### HEATED GRIPS AND SWITCHES

Warm hands feel good, which is why these heated handlebar grips have two settings designed to keep hands and fingers pleasantly warm.

For more detailed information, contact your BMW Motorrad dealership or go online at [bmw-motorrad.com](http://bmw-motorrad.com).

To be fitted and/or enabled in a specialist workshop, and ideally at your BMW Motorrad dealership.



## EQUIPMENT FOR THE BMW R 1200 RS



## HP PARTS

### HP SPORT SILENCER

Made entirely out of titanium and stainless steel and to an exceptional level of craftsmanship, this slip-on silencer with carbon end-cap and heat guard delivers a powerful rumble. It's also remarkably lightweight (1 kg lighter than standard version).

#### PART NUMBERS

##### HP sport silencer

Order number: 77 11 8 545 726\*

Mounting instructions are available from your BMW Motorrad dealership.

(+) Carbon heat guard without centre stand

Order number: 77 11 8 554 341\*

(o) Carbon heat guard with centre stand

Order number: 77 11 8 556 703\*

(+) Raised head screw (one required)

Order number: 06 32 7 651 211\*



### HP MILLED BRAKE AND CLUTCH LEVERS

The CNC-milled HP hand levers made from corrosion-resistant, anodized aluminium are adjustable via a screw mechanism (brake lever 5 positions, clutch lever 3 positions).

To be fitted and/or enabled in a specialist workshop, and ideally at your BMW Motorrad dealership.

#### ITEM NUMBERS

HP milled clutch lever (image 1)

Order number: 77 25 8 554 323\*

(+) HP milled brake lever (image 2)

Order number: 77 25 8 554 324\*

(+) = "and" – this item must be ordered at the same time

(o) = "or" – this item may be ordered as an alternative option

## STORAGE

### TOURING PANNIERS

Sturdy, splash-proof touring panniers with pannier lid paintwork in Granite Grey Matt Metallic provide total storage capacity of approx. 63 l (approx. 32 l left, 31 l right). Each pannier can hold a 10 kg load. The left pannier has ample space for one helmet. Pannier base can be expanded for easier loading and unloading.

For information on speed and load limitations, please refer to the instruction booklet.

#### PART NUMBERS

##### Touring pannier, left

Order number: 77 41 8 536 869\*

##### Touring pannier, right

Order number: 77 41 8 536 870\*

(+) Mounting kit

Order number: 71 60 7 680 840\*

(+) Locking cylinder (with codes) for central locking with motorcycle

Order number: 51 25 7 681 200\*

(o) Repair kit for locking cylinder

Order number: 51 25 7 698 204\*

Mounting parts and locking cylinder variant (one required per pannier)



### INNER BAGS FOR TOURING PANNIERS

These practical, water-resistant inner bags make full use of the capacity of the touring panniers. Luggage can be accessed easily with one hand, and the bag can even be worn over the shoulder thanks to a detachable strap.

#### PART NUMBER

Inner bag for touring pannier, left

Order number: 77 41 8 549 407\*

Inner bag for touring pannier, right

Order number: 77 41 8 549 408\*

\* Original BMW Motorrad equipment is available from your BMW Motorrad dealer.



**PANNIER HOLDERS**

These sturdy pannier racks blend in perfectly with the vehicle's overall design – even when the panniers have been removed – and firmly secure the touring panniers, quickly and easily.

**PART NUMBER**

**Pannier racks**

Order number: 46 54 8 534 255\*  
To be fitted and/or enabled in a specialist workshop, and ideally at your BMW Motorrad dealership.  
Small mounting parts included.  
(+) Mushroom-head fixing screw (two required)  
Order number: 46 54 8 534 265\*



**LUGGAGE GRID**

A secure base for the small top box, suitable for use with the BMW R 1200 RS. Paintwork in Granite Grey Matt Metallic.  
To be fitted and/or enabled in a specialist workshop, and ideally at your BMW Motorrad dealership.

**PART NUMBERS**

**Luggage grid**

Order number: 46 54 8 534 258\*  
(+) Luggage grid lower section  
Order number: 46 54 8 534 264\*  
(+) Luggage grid lower section, Granite Grey Matt Metallic  
Order number: 46 54 8 556 661\*  
(+) Attachments for luggage grid  
Order number: 77 44 8 546 695\*



**SMALL TOP BOX AND BACKREST PAD**

The waterproof top box has a capacity of 30 l and a maximum load of 5 kg – perfect for a helmet, for example. The lid comes with paintwork in Granite Grey Metallic and a soft-close mechanism; backrest pad and central locking functionality are also available upon request.  
For information on speed and load limitations, please refer to the instruction booklet.

**PART NUMBERS**

**Small top box**

Order number: 77 43 8 543 246\*  
Small mounting parts included.  
(+) Top box lid outer shell in Granite Grey Matt Metallic  
Order number: 77 43 8 553 127\*  
(+) Badge  
Order number: 31 42 7 708 518\*  
(+) Locking cylinder (with codes) for central locking with motorcycle  
Order number: 51 25 7 681 200\*  
(o) Repair kit for locking cylinder  
Order number: 51 25 7 698 204\*  
Locking cylinder variant (one required)  
**Backrest pad for small top box**  
Order number: 77 44 8 549 334\*

**PART NUMBER**

**Small tank bag**

Order number: 77 45 8 556 293\*



**BAG FOR PILLION SEAT**

This waterproof bag attaches to the pillion seat and offers 16 l of extra storage – just the right amount for day trips or even the daily commute. Along with the tank bag, it's the perfect way to add storage space.  
For solo riding only.

**PART NUMBER**

**Bag for pillion seat**

Order number: 77 49 8 557 768\*



**INNER BAG FOR SMALL TOP BOX**

Makes loading and unloading a top box even easier. The inner bag comes with a practical carry handle making it easy to transport and can be folded flat when not in use.

**PART NUMBER**

**Inner bag for small top box**

Order number: 77 43 8 549 130\*



**SMALL TANK BAG**

The capacity of the waterproof main compartment is expandable from 5 to 9l. The high-quality waterproof map pocket comes with non-slip polyurethane coating. With additional water-repellent exterior pockets, carry handle and adjustable shoulder strap.

(+) = "and" – this item must be ordered at the same time  
(o) = "or" – this item may be ordered as an alternative option

\* Original BMW Motorrad equipment is available from your BMW Motorrad dealer.

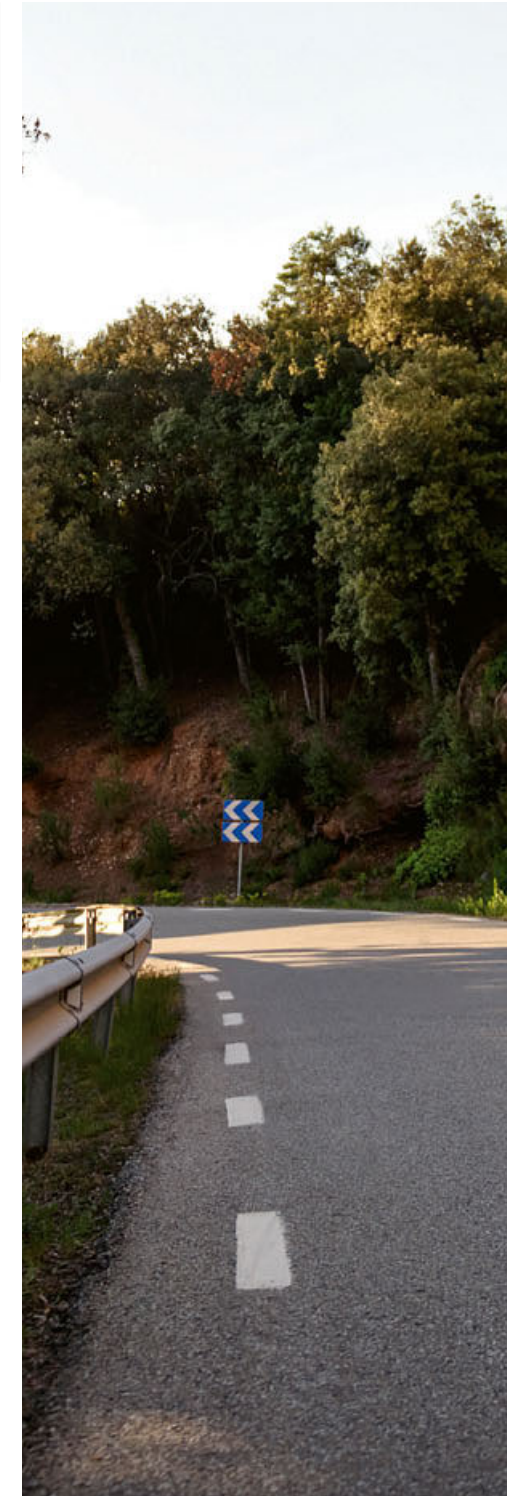

## DESIGN



### LED INDICATORS

Cutting-edge design inside and out. The LED indicators complement the design of the BMW R 1200 RS perfectly – and thanks to reduced energy consumption and significantly longer bulb life, they're also a shining example of efficiency.

To be fitted and/or enabled in a specialist workshop, and ideally at your BMW Motorrad dealership.

#### ITEM NUMBERS

**LED indicators** (three required)  
Order number: 63 13 8 522 499\*

**LED indicators** (one required)  
Order number: 63 13 8 522 503\*



### PLASTIC ENGINE SPOILER IN BIKE COLOUR

The elegant engine spoiler underlines the stylish, sporty look of the BMW R 1200 RS. To be fitted and/or enabled in a specialist workshop, and ideally at your BMW Motorrad dealership.

Not available in conjunction with engine protection bar.

**Small mounting parts are not included.**

#### PART NUMBERS

**Engine spoiler in Black Storm Metallic, left**  
Order number: 46 63 8 542 513\*

(+) Engine spoiler in Black Storm Metallic, right  
Order number: 46 63 8 542 514\*

**Engine spoiler in Magellan Grey Metallic, left**  
Order number: 46 63 8 565 857\*

(+) Engine spoiler in Magellan Grey Metallic, right  
Order number: 46 63 8 565 858\*

(+) Bracket (left) for engine spoiler  
Order number: 46 63 8 546 955\*

(+) Bracket (right) for engine spoiler  
Order number: 46 63 8 546 956\*

(+) = "and" – this item must be ordered at the same time  
(o) = "or" – this item may be ordered as an alternative option

## ERGONOMICS & COMFORT

### TINTED WINDSHIELD

The tinted version of the standard windshield underlines the powerful yet refined look of the BMW R 1200 RS.

With scratch-resistant coating.

To be fitted and/or enabled in a specialist workshop, and ideally at your BMW Motorrad dealership.

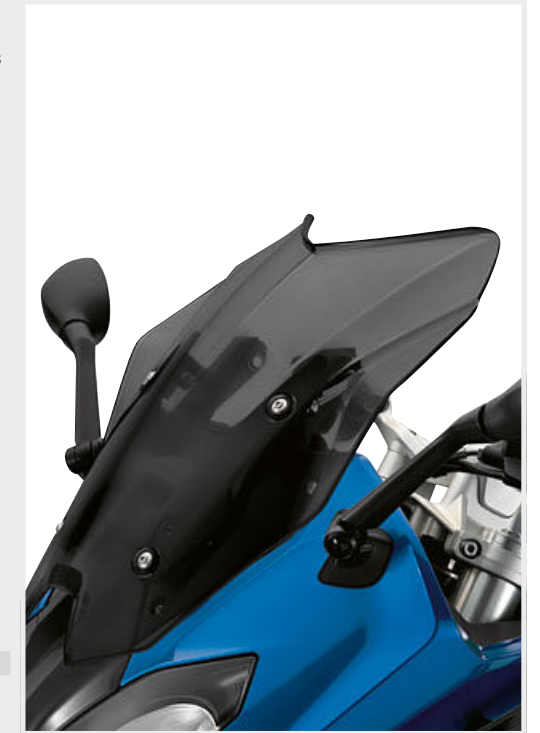

#### PART NUMBER

**Tinted windshield**  
Order number: 77 33 8 556 927

### RIDER AND PILLION SEATS

The choice is yours. We make seats that give you the perfect knee angle, lower seats that allow you to keep the ground within easy reach, and padded seats for greater comfort. All rider seats are also available ex works. You can even have the pillion seat adjusted accordingly.

#### PART NUMBERS

**Rider seat, Black** (not shown) (seat height: 820 mm; step length: 1,835 mm)  
Order number: 52 53 8 534 318\*

**Low rider seat, Black** (image 1) (seat height: 790 mm; step length: 1,780 mm)  
Order number: 52 53 8 534 316\*

**Extra low rider seat, Black** (image 2) (seat height: 760 mm; step length: 1,720 mm)  
Order number: 52 53 8 534 317\*

**Pillion seat** (not shown)  
Order number: 52 53 8 534 319\*

**Comfort pillion seat** (not shown)  
Order number: 52 53 8 534 320\*



### SPORT RIDER SEAT, BLACK

The high and narrow sport rider seat facilitates an active body position for more dynamic riding. Even taller riders will feel at home on it. Also available as an equipment option.

#### ITEM NUMBER

**Sport rider seat, Black**  
(seat height: 840 mm; step length: 1,875 mm)  
Order number: 77 34 8 555 886

\* Original BMW Motorrad equipment is available from your BMW Motorrad dealer.

### HEATED GRIPS AND SWITCHES

Warm hands feel good, which is why these heated handlebar grips have two settings designed to keep hands and fingers pleasantly warm. Also available as an equipment option.

For more detailed information, contact your BMW Motorrad dealership or go online at [bmw-motorrad.com](http://bmw-motorrad.com).

To be fitted and/or enabled in a specialist workshop, and ideally at your BMW Motorrad dealership.



### CENTRE STAND

The sturdy centre stand ensures that the bike remains stable even on loose surfaces.

To be fitted and/or enabled in a specialist workshop, and ideally at your BMW Motorrad dealership.



### MILLED FOOT PEGS, ADJUSTABLE (INCLUDING FOOTBRAKE AND GEAR LEVER)

Riders can adjust the high-quality CNC-milled driver foot pegs to any of three settings, keeping their feet comfortably and securely in position. Footbrake and gear levers can be adjusted to accommodate different leg lengths and even different boot sizes.

To be fitted and/or enabled in a specialist workshop, and ideally at your BMW Motorrad dealership.



#### ITEM NUMBER

**Milled foot peg, left, adjustable**

Order number: 77 25 8 552 071

(+) Milled foot peg, right, adjustable

Order number: 77 25 8 552 072

#### PART NUMBER

Centre stand

Order number: 46 52 8 532 725

(+) Plain bearing bolt (two required)

Order number: 46 52 8 526 527

(+) Circlip 18x1.2 (two required)

Order number: 07 11 9 934 120

(+) Tension spring (two required)

Order number: 46 52 7 699 005

(+) Spring pre-loaded tensioning plate (two required)

Order number: 46 52 8 526 528

(+) Buffer (one required)

Order number: 46 52 2 332 218

(+) Rubber stop (one required)

Order number: 46 53 2 335 617

## NAVIGATION AND COMMUNICATION



### BMW MOTORRAD NAVIGATION SYSTEMS

Where am I? Where do I want to go, and what's the most scenic way to get there?

BMW Motorrad navigation devices show you where to go. Made specifically for motorcyclists, they're easy to fit and use – even with gloves on – and come with lifetime map updates.

The new BMW Motorrad Navigator VI is your ticket to the tour of your dreams. A whole new level of adventure awaits thanks to the “winding roads” route option, “avoid motorways” feature and the “round trip” function, which configures journeys based on time, distance or stopover. The circular polarization filter (CPOL) on the display minimizes reflection and improves contrast, ensuring the screen is easy to read, even in direct sunlight. 16 GB of flash storage, and the ability to stream music from your smartphone, are the ultimate luxury.

For more detailed information, contact your BMW Motorrad dealership or go online at [bmw-motorrad.com](http://bmw-motorrad.com).

Only available in conjunction with “Navigation device preparation” (also available as an equipment option, option code 272)

“My motorcycle” page only available in conjunction with Pro on-board computer.

#### ITEM NUMBERS

**BMW Motorrad Navigator VI**

(with map data for Europe)

Order number: 77 52 8 355 994

(o) BMW Motorrad Navigator VI (without map data)

Order number: 77 52 8 356 005

# SAFETY

## STAINLESS STEEL ENGINE PROTECTION BAR

The stainless steel engine protection bar provides effective protection for the cylinders without compromising the lean angle. Mounting instructions are available from your BMW Motorrad dealership. Not for use in conjunction with the engine spoiler.



### PART NUMBERS

**Engine protection bar, left**  
Order number: 77 14 8 557 607\*

**Engine protection bar, right**  
Order number: 77 14 8 557 608\*

(+) Mounting parts  
Order number: 77 14 8 522 926\*

(+) Cylinder screw M8x30 (two required)  
Order number: 07 12 9 907 381\*

(+) Cylinder screw M8x35 (two required)  
Order number: 07 12 9 908 654\*

## STAINLESS STEEL CYLINDER HEAD COVER GUARD

If the worst comes to the worst, the cylinder head cover guard provides comprehensive protection against damage. Plastic contact guard is replaceable. Mounting instructions are available from your BMW Motorrad dealership.

### PART NUMBER

Cylinder head cover guard  
Order number: 77 14 8 533 745



## LED AUXILIARY HEADLIGHTS

The LED auxiliary headlights deliver increased safety when visibility is poor, e.g. in fog, snow and rain. To be fitted and/or enabled in a specialist workshop, and ideally at your BMW Motorrad dealership. For more detailed information, contact your BMW Motorrad dealership or go online at [bmw-motorrad.com](http://bmw-motorrad.com). **Small mounting parts are not included.**

### PART NUMBERS

**LED auxiliary headlights** (two required)  
Order number: 63 17 8 556 937

The auxiliary headlights are approved for use as fog lights, and may only be used in poor weather conditions. Country-specific road traffic regulations apply.

(+) Bracket for LED auxiliary headlights  
Order number: 77 51 8 551 341

(+) Cable harness for LED auxiliary headlights  
Order number: 77 51 8 553 657

(+) Additional switch for LED auxiliary headlights  
Order number: 61 31 8 533 473

(+) Cable clamp  
Order number: 32 72 8 534 367



## SAFETY SCREW FOR OIL FILLER CAP

Safety screw for oil filler cap

### ITEM NUMBER

**Safety screw for oil filler cap**  
Order number: 71 60 7 696 117

## ANTI-THEFT ALARM SYSTEM (NOT SHOWN)

If the motorcycle is moved or struck violently, the system responds with a clearly audible signal and a flashing warning light. To be fitted and/or enabled in a specialist workshop, and ideally at your BMW Motorrad dealership. **Small mounting parts are not included.**

### PART NUMBER

**Anti-theft alarm system**  
Order number: 77 53 8 554 348\*

## PRO RIDING MODES RETROFIT (NOT SHOWN)

Pro riding modes retrofit. For more detailed information, contact your BMW Motorrad dealership or go online at [bmw-motorrad.com](http://bmw-motorrad.com). To be fitted and/or enabled in a specialist workshop, and ideally at your BMW Motorrad dealership.







**WAKE UP TO  
LIFE EVERY MORNING  
WITH YOUR  
ENGINE RUNNING.  
BE IMPATIENT TO GET OUT  
AND GET ON IT.**

C 650 GT	50
C 650 Sport	58
C evolution	66



**URBAN  
MOBILITY**

## EQUIPMENT FOR THE C 650 GT.



## STORAGE

### BACKREST PAD FOR TOP BOX (35 L)

#### PART NUMBER

#### Backrest pad for top box (35 l)

Order number: 77 44 8 527 002\*  
Model shown: BMW C 650 GT, 2015.



### INNER BAG FOR TOP BOX

The practical, rigid inner bag with waterproof main compartment keeps its contents well protected. The capacity of the top box is fully utilized, and loading and unloading is quick and easy.

#### PART NUMBER

#### Inner bag for top box

Order number: 77 43 8 527 035\*



### LUGGAGE GRID

The sturdy, stylish luggage grid is ideal for securing the top box or other large items of luggage. Can be used while the backrest is fitted.

#### PART NUMBERS

#### Luggage grid

Order number: 77 44 8 566 025\*

(+) Metal frame insert kit (two required)

Order number: 77 44 8 555 129\*

(+) High-strength screw lock

Order number: 83 19 2 210 337\*



### TOP BOX, 35 l

The waterproof top box is available with lid trims in the same colour as the maxi-scooter itself. The optional backrest pad offers additional comfort for the pillion passenger.

– Ocean Blue Metallic Matt  
Order number: 77 43 8 389 277

– Light White  
Order number: 77 43 8 555 957

– Black Storm Metallic  
Order number: 77 43 8 563 801

(+) Trim, right

To be fitted and/or enabled in a specialist workshop, and ideally at your BMW Motorrad dealership.

– Ocean Blue Metallic Matt  
Order number: 77 43 8 389 278

– Light White  
Order number: 77 43 8 555 956

– Black Storm Metallic  
Order number: 77 43 8 563 802

#### PART NUMBERS

#### Top box, 35 l

Order number: 77 43 8 542 047

Only available in conjunction with luggage grid.

Top box and backrest for passenger cannot be fitted together.

For information on speed and load limitations, please refer to the instruction booklet.

(+) Locking cylinder (with codes) for central locking with motorcycle

Order number: 77 44 8 542 498

(o) Repair kit for locking cylinder

Order number: 51 25 8 546 428

(+) Trim, left

To be fitted and/or enabled in a specialist workshop, and ideally at your BMW Motorrad dealership.



### PARTITION NET FOR LUGGAGE COMPARTMENT

Divides the storage compartment below the seat into two sections when required, e.g. for transporting small items. It can be installed and removed quickly, and is easy to tuck away when not in use.

#### PART NUMBER

#### Partition net for luggage compartment

Order number: 77 49 8 527 034\*

### CENTRE TUNNEL BAG

Fits the maxi-scooter perfectly, and offers a 12-l capacity, waterproof main compartment, a detachable shoulder strap and a top pocket for small items. Can be attached and removed quickly and easily.

#### PART NUMBER

#### Centre tunnel bag

Order number: 77 45 8 527 014\*



## DESIGN

### CHROME PARTS

The chrome-plated footrest inserts and handlebar weights add a classy, personal touch to the scooter. To be fitted and/or enabled in a specialist workshop, and ideally at your BMW Motorrad dealership.

#### ITEM NUMBERS

**Chrome-plated footrest insert, left** (image 1)

Order number: 77 25 8 527 205\*

(+) Chrome-plated footrest insert, right

Order number: 77 25 8 527 206\*

(+) Chrome-plated footrest insert, centre left

Order number: 77 25 8 527 206\*

(+) Chrome-plated footrest insert, centre right

Order number: 77 25 8 527 205\*

(+) Chrome-plated footrest insert, rear left (see image, left)

Order number: 77 25 8 527 207\*

(+) Chrome-plated footrest insert, rear right

Order number: 77 25 8 527 208\*



### CHROME PARTS

#### ITEM NUMBERS

**Chrome-plated handlebar weight** (two required)

Order number: 77 22 8 527 001\*

Use of chrome-plated handlebar weight is restricted when scooter lock is fitted (scooter lock fastener takes the place of left handlebar weight).



## ERGONOMICS & COMFORT

### HEATED SEAT AND HEATED GRIPS

For a comfortable ride even in cooler weather: there are separate controls for the seat heating for both the driver and passenger, and the driver can select from three different temperatures for the heated grips. To be fitted and/or enabled in a specialist workshop, and ideally at your BMW Motorrad dealership.

#### ITEM NUMBERS

**Heated seat**

(seat height: 805 mm; step length: 1,910 mm)

Order number: 77 34 8 555 449\*

**Heated grip, left**

Order number: 61 31 7 721 851\*

(+) Heated grip, right

Order number: 61 31 8 522 480\*

(+) Multifunction switch for heated grips

Order number: 61 31 8 546 704\*

(o) Multifunction switch for heated grips and seat heating

Order number: 61 31 8 546 708\*



### LOW SEAT

20mm lower than the standard version, this low rider seat makes climbing on and handling easier. Not compatible with seat heating retrofit.

#### ITEM NUMBER

**Low seat**

(seat height: 785 mm; step length: 1,855 mm)

For more detailed information, contact your BMW Motorrad dealership or go online at [bmw-motorrad.com](http://bmw-motorrad.com).

Order number: 52 53 8 555 450\*



### EXCLUSIVE SEAT

Instantly inviting, the Exclusive seat features decorative stitching and a high-quality look and feel. It's also available with seat heating, with separate settings for rider and passenger.

To be fitted and/or enabled in a specialist workshop, and ideally at your BMW Motorrad dealership.

Seat heating function retrofittable on vehicles that do not have option code 518 "seat heating"; new multifunction switch and adapter cable required.

#### ITEM NUMBER

**Exclusive seat**

(seat height: 805 mm; step length: 1,910 mm)

Order number: 77 34 8 527 042\*





### RAIN COVER FOR SEAT

Snug, waterproof protective cover, secured under the seat with a rubber strap. Packs down to a small size, includes transport bag.

#### PART NUMBER

**Rain cover for seat**  
Order number: 77 34 8 527 016\*

### WIND DEFLECTORS

Effective wind protection for the rider's hands. The black plastic wind deflectors are securely attached to the fairing panels.

#### PART NUMBER

**Wind deflectors**  
Order number: 77 31 8 527 006\*



### SCOOTER LEG COVER

This waterproof protective cover is quick to attach and secure, keeping your favourite trousers safe from spray and offering extra insulation against the cold when needed. Can be protected from unauthorized removal with the optional scooter lock.

To be fitted and/or enabled in a specialist workshop, and ideally at your BMW Motorrad dealership.

#### PART NUMBERS

**Scooter leg cover**  
Order number: 77 31 8 527 012\*  
(+) Plug-in nut M5 (four required)  
Order number: 46 63 7 707 388\*  
(+) Screw M5x12 (four required)  
Order number: 06 32 7 651 211\*



### SEAT HEATING RETROFIT (NOT SHOWN)

For more detailed information, contact your BMW Motorrad dealership or go online at [bmw-motorrad.com](http://bmw-motorrad.com).

#### PART NUMBERS

**Adapter cable for seat heating**  
Order number: 61 12 8 525 432\*  
(+) Multifunction switch for seat heating  
Order number: 61 31 8 546 172\*  
(o) Multifunction switch for heated grips and seat heating  
Order number: 61 31 8 546 174\*

### BACKREST FOR PASSENGER (NOT SHOWN)

With padding and artificial leather in Black, the backrest delivers greater comfort for the passenger, and can be used in conjunction with the luggage grid (without top box).

To be fitted and/or enabled in a specialist workshop, and ideally at your BMW Motorrad dealership.

Top box and backrest for passenger cannot be fitted together.

#### PART NUMBERS

**Backrest for passenger**  
Order number: 77 34 8 527 046\*  
(+) Luggage grid holder  
Order number: 77 44 7 725 160\*

### COVER

Snug and waterproof yet breathable, this cover protects your maxi-scooter from rain, dirt and more. Made of tear-resistant, UV-resistant material.

#### PART NUMBER

**Wind deflectors**  
Order number: 77 8 527 017\*

(+) = "and" – this item must be ordered at the same time  
(o) = "or" – this item may be ordered as an alternative option

## NAVIGATION AND COMMUNICATION



### BMW MOTORRAD NAVIGATION SYSTEMS

Where am I? Where do I want to go, and what's the most scenic way to get there?

BMW Motorrad navigation devices show you where to go. Made specifically for motorcyclists, they're easy to fit and use – even with gloves on – and come with lifetime map updates.

The new BMW Motorrad Navigator VI is your ticket to the tour of your dreams. A whole new level of adventure awaits thanks to the "winding roads" route option, "avoid motorways" feature and the "round trip" function, which configures journeys based on time, distance or stopover. The circular polarization filter (CPOL) on the display minimizes reflection and improves contrast, ensuring the screen is easy to read, even in direct sunlight. 16 GB of flash storage, and the ability to stream music from your smartphone, are the ultimate luxury.

Thanks to Bluetooth® technology, the sophisticated BMW Motorrad Navigator Street (with easy-to-read 4.3" display) is compatible with the optional BMW Motorrad communication system and comes with a host of handy features.

BMW Motorrad navigation devices and the BMW Motorrad smartphone cradle can only be mounted using the BMW Motorrad navigation device bracket.

For more detailed information, contact your BMW Motorrad dealership or go online at [bmw-motorrad.com](http://bmw-motorrad.com).

### BMW USB CHARGER (NOT SHOWN)

For operating and charging mobile phones and consumer electronic devices via USB interface or standard power socket.

#### PART NUMBERS

**BMW USB charger**  
Order number: 65 41 2 166 411\*  
**BMW dual USB charger**  
Order number: 65 41 2 166 420\*



### BMW MOTORRAD SMARTPHONE CRADLE

Now you can charge your phone out on the road with BMW Motorrad's waterproof smartphone cradle. Charging takes place wirelessly or via a plug-in connection. The display and navigation functions are perfectly positioned in your field of vision and can be easily operated from the cradle. For smartphones with 5" displays or smaller. Max. dimensions: 13.8 cm x 7.3 cm x 1.1 cm. Only in combination with bracket for BMW Motorrad navigation devices.

#### ITEM NUMBERS

**BMW Motorrad Navigator VI with mount cradle** (with map data for Europe)  
Order number: 77 52 8 355 749\*

**BMW Motorrad Navigator VI** (without map data)  
Order number: 77 52 8 356 005\*

(+) 4-button cradle mount  
Order number: 77 52 8 544 464\*

**BMW Motorrad Navigator Street**  
Order number: 77 52 8 557 855\*

**Bracket for BMW Motorrad navigation devices C 650 GT**  
Order number: 77 52 8 356 870\*

(+) Decoupling sleeve (four required)  
Order number: 65 90 8 535 827\*

(+) Cable tie  
Order number: 61 13 1 367 599\*

Mounting instructions are available from your BMW Motorrad dealership.

#### PART NUMBER

**BMW Motorrad smartphone cradle**  
Order number: 77 52 8 563 125\*

\* Original BMW Motorrad equipment is available from your BMW Motorrad dealer.

# SAFETY

## ANTI-THEFT ALARM SYSTEM (NOT SHOWN)

If the motorcycle is moved or struck violently, the system responds with a clearly audible signal and a flashing warning light.

To be fitted and/or enabled in a specialist workshop, and ideally at your BMW Motorrad dealership.

Also available as an equipment option.

### PART NUMBERS

#### Anti-theft alarm system

Order number: 77 53 8 554 348\*

(+) Bracket for anti-theft alarm system

Order number: 77 53 8 525 488\*

(+) Clip nut (one required)

Order number: 07 14 8 541 623\*

(+) Raised head screw (three required)

Order number: 06 32 7 651 203\*



## SCOOTER LOCK

The scooter lock ensures that the maxi-scooter stays exactly where it was left. For example, the end of the handlebars can be secured using the swing arm or an immovable object.

To be fitted and/or enabled in a specialist workshop, and ideally at your BMW Motorrad dealership.

Use of chrome-plated handlebar weight is restricted when scooter lock is fitted (scooter lock fastener takes the place of left handlebar weight).

Model shown: BMW C 650 GT, 2015.

### PART NUMBERS

#### Scooter lock

Order number: 77 25 8 527 047\*

(+) M12 x 50 screw (one required)

Order number: 07 12 9 906 088\*

## CRASH PADS

Attached to the sides of the front fairing panels and the footrests, the crash pads protect the vehicle from damage in the event of an accident.

For more detailed information, contact your BMW Motorrad dealership or go online at [bmw-motorrad.com](http://bmw-motorrad.com).

To be fitted and/or enabled in a specialist workshop, and ideally at your BMW Motorrad dealership.

Model shown: BMW C 650 GT, 2015.

### PART NUMBER

#### Crash pads

Order number: 77 03 8 555 385\*



## ASPHERICAL MIRROR

The curved surface of the aspherical mirror increases the range of vision, almost completely eliminating blind spots when correctly adjusted.

To be fitted and/or enabled in a specialist workshop, and ideally at your BMW Motorrad dealership.

### PART NUMBERS

#### Aspherical mirror, left

Order number: 77 31 8 527 285\*

(+) Aspherical mirror, right

Order number: 77 31 8 527 286\*



\* Original BMW Motorrad equipment is available from your BMW Motorrad dealer.

## EQUIPMENT FOR THE C 650 SPORT



## STORAGE

### INNER BAG FOR TOP BOX

The practical, rigid inner bag with waterproof main compartment keeps its contents well protected. The capacity of the top box is fully utilized, and loading and unloading is quick and easy.

#### PART NUMBER

**Inner bag for top box**  
Order number: 77 43 8 527 035\*

### CENTRE TUNNEL BAG

Fits the maxi-scooter perfectly, and offers a 12-l capacity, waterproof main compartment, a detachable shoulder strap and a top pocket for small items. Can be attached and removed quickly and easily.

#### PART NUMBER

**Centre tunnel bag**  
Order number: 77 45 8 551 271\*



### LUGGAGE GRID

The sturdy, stylish luggage grid is ideal for securing the top box or other large items of luggage. Can be used while the backrest is fitted.

#### PART NUMBERS

**Luggage grid**  
Order number: 77 44 8 564 067\*  
(+) Grab handle, left  
Order number: 46 72 8 527 814\*  
(+) Grab handle, right  
Order number: 46 72 8 527 818\*



### BACKREST PAD FOR TOP BOX (35L)

#### PART NUMBER

**Backrest pad for top box (35 l)**  
Order number: 77 44 8 527 002\*  
Model shown: BMW C 650 Sport, 2015.

(+) = "and" – this item must be ordered at the same time  
(o) = "or" – this item may be ordered as an alternative option



### TOP BOX 35 l

The waterproof top box is available with lid trims in the same colour as the maxi-scooter itself. The optional backrest pad offers additional comfort for the pillion passenger.

– Austin Yellow Metallic  
Order number: 77 43 8 389 275  
– Light White  
Order number: 77 43 8 555 957  
– Black Storm Metallic  
Order number: 77 43 8 563 801

(+) Trim, right  
To be fitted and/or enabled in a specialist workshop, and ideally at your BMW Motorrad dealership.

– Austin Yellow Metallic  
Order number: 77 43 8 389 276  
– Light White  
Order number: 77 43 8 555 956  
– Black Storm Metallic  
Order number: 77 43 8 563 802

#### PART NUMBERS

**Top box, 35 l**  
Order number: 77 43 8 542 047  
Only available in conjunction with luggage grid.  
Top box and backrest for passenger cannot be fitted together.  
For information on speed and load limitations, please refer to the instruction booklet.  
(+) Locking cylinder (with codes) for central locking with motorcycle  
Order number: 77 44 8 542 498  
(o) Repair kit for locking cylinder  
Order number: 51 25 8 546 428  
(+) Trim, left  
To be fitted and/or enabled in a specialist workshop, and ideally at your BMW Motorrad dealership.

\* Original BMW Motorrad equipment is available from your BMW Motorrad dealer.



### PARTITION NET FOR LUGGAGE COMPARTMENT

Divides the storage compartment below the seat into two sections when required, e.g. for transporting small items. It can be installed and removed quickly, and is easy to tuck away when not in use.

#### PART NUMBER

**Partition net for luggage compartment**  
Order number: 77 49 8 527 033\*  
(+) Blind rivet nut, uncoupled (four required)  
Order number: 46 63 2 347 012\*  
(+) Raised head screw (four required)  
Order number: 06 32 7 657 966\*

## DESIGN

### CHROME PARTS

#### ITEM NUMBERS

**Chrome-plated handlebar weight** (two required)  
Order number: 77 22 8 527 001\*  
Use of chrome-plated handlebar weight is restricted when scooter lock is fitted (scooter lock fastener takes the place of left handlebar weight).



### CHROME PARTS

The chrome-plated footrest inserts and handlebar weights add a classy, personal touch to the scooter. To be fitted and/or enabled in a specialist workshop, and ideally at your BMW Motorrad dealership.

#### ITEM NUMBERS

- Chrome-plated footrest insert, left**  
Order number: 77 25 8 527 057\*
- (+) Chrome-plated footrest insert, right  
Order number: 77 25 8 527 058\*
- (+) Chrome-plated footrest insert, centre left  
Order number: 77 25 8 527 059\*
- (+) Chrome-plated footrest insert, centre right  
Order number: 77 25 8 527 060\*
- Chrome-plated pillion foot peg, left** (not shown)  
Order number: 77 25 8 527 303\*
- (+) Chrome-plated pillion foot peg, right  
Order number: 77 25 8 527 304\*
- (+) Bolts (two required)  
Order number: 46 71 7 668 644\*
- (+) Footrest bracket (two required)  
Order number: 46 51 8 527 138\*
- (+) Torsion spring (two required)  
Order number: 46 71 7 664 148\*
- (+) ISA screw (three required)  
Order number: 07 12 9 905 122\*
- (+) ISA screw (one required)  
Order number: 07 12 9 905 768\*
- (+) Pillion foot peg stop plate (two required)  
Order number: 46 71 8 527 079\*
- (+) Locking washer (two required)  
Order number: 07 11 9 901 545\*
- (+) Ball bearings (two required)  
Order number: 07 11 9 905 155\*



## ERGONOMICS & COMFORT

### HEATED SEAT AND HEATED GRIPS

For a comfortable ride even in cooler weather: there are separate controls for the seat heating for both the driver and passenger, and the driver can select from three different temperatures for the heated grips. To be fitted and/or enabled in a specialist workshop, and ideally at your BMW Motorrad dealership.

#### ITEM NUMBERS

- Heated seat**  
(seat height: 800 mm/step length: 1,830 mm)  
Order number: 52 53 8 555 444\*
- Heated grip, left**  
Order number: 61 31 7 721 851\*
- (+) Heated grip, right  
Order number: 61 31 8 522 480\*
- (+) Multifunction switch for heated grips  
Order number: 61 31 8 546 704\*
- (o) Multifunction switch for heated grips and seat heating  
Order number: 61 31 8 546 708\*



### TINTED WINDSHIELD

Adds a personal touch to the BMW C 650 Sport maxi-scooter. With scratch-resistant coating for durability and unimpeded visibility. To be fitted and/or enabled in a specialist workshop, and ideally at your BMW Motorrad dealership.

#### PART NUMBER

**Tinted windshield**  
Order number: 77 33 8 559 586\*



### SPORT WINDSHIELD

Gives the vehicle a sportier look (tinted version also available). With scratch-resistant coating for durability and unimpeded visibility. To be fitted and/or enabled in a specialist workshop, and ideally at your BMW Motorrad dealership.

#### ITEM NUMBERS

**Sport windshield** (not shown)  
Order number: 77 33 8 559 587\*

**Sport windshield, tinted**  
Order number: 77 33 8 559 588\*



### LOW SEAT

20 mm lower than the standard version, this low rider seat makes climbing on and handling easier. Not heated, also available as an equipment option.

#### ITEM NUMBER

**Low seat**  
(seat height: 780 mm; step length: 1,810 mm)  
For more detailed information, contact your BMW Motorrad dealership or go online at [bmw-motorrad.com](http://bmw-motorrad.com).  
Order number: 52 53 8 546 268\*



### SPORT SEAT

Instantly inviting, the sport seat features decorative stitching and is also available with seat heating, with separate settings for rider and passenger.

To be fitted and/or enabled in a specialist workshop, and ideally at your BMW Motorrad dealership.

Seat heating function retrofittable on vehicles that do not have option code 518 "seat heating"; new multifunction switch and adapter cable required.

#### ITEM NUMBERS

**Sport seat**  
(seat height: 800 mm; step length: 1,830 mm)  
Order number: 52 53 8 552 099\*

**Sport seat, heated**  
(seat height: 800 mm; step length: 1,830 mm)  
Order number: 77 34 8 527 039\*



### RAIN COVER FOR SEAT

Snug, waterproof protective cover, secured under the seat with a rubber strap. Packs down to a small size, includes transport bag.

#### PART NUMBER

**Rain cover for seat**  
Order number: 77 34 8 527 016\*



### SCOOTER LEG COVER

This waterproof protective cover is quick to attach and secure, keeping your favourite trousers safe from spray and also offering extra insulation against the cold when needed. Can be protected from unauthorized removal with the optional scooter lock.

To be fitted and/or enabled in a specialist workshop, and ideally at your BMW Motorrad dealership.

#### PART NUMBERS

**Scooter leg cover**  
Order number: 77 31 8 527 011\*  
(+) Plug-in nut M5 (ten required)  
Order number: 61 31 8 546 172\*

(+) Screw M5x12 (ten required)  
Order number: 06 32 7 651 211\*



### BACKREST FOR PASSENGER

With padding and artificial leather in Black, the backrest delivers greater comfort for the passenger, and can be used in conjunction with the luggage grid (without top box).

To be fitted and/or enabled in a specialist workshop, and ideally at your BMW Motorrad dealership.

Top box and backrest for passenger cannot be fitted together.

#### PART NUMBERS

**Backrest for passenger**  
Order number: 77 34 8 527 045\*  
(+) Grab handle, left  
Order number: 46 72 8 527 814

(+) Grab handle, right  
Order number: 46 72 8 527 818

(+) = "and" – this item must be ordered at the same time  
(o) = "or" – this item may be ordered as an alternative option

## NAVIGATION AND COMMUNICATION



### BMW MOTORRAD SMARTPHONE CRADLE

Now you can charge your phone out on the road with BMW Motorrad's waterproof smartphone cradle. Charging takes place wirelessly or via a plug-in connection. The display and navigation functions are perfectly positioned in your field of vision and can be easily operated from the cradle. For smartphones with 5" displays or smaller. Max. dimensions: 13.8 cm x 7.3 cm x 1.1 cm. Only in combination with bracket for BMW Motorrad navigation devices.

#### PART NUMBER

**BMW Motorrad smartphone cradle**  
Order number: 77 52 8 563 125\*



### BMW MOTORRAD NAVIGATION SYSTEMS

Where am I? Where do I want to go, and what's the most scenic way to get there?

BMW Motorrad navigation devices show you where to go. Made specifically for motorcyclists, they're easy to fit and use – even with gloves on – and come with lifetime map updates.

The new BMW Motorrad Navigator VI is your ticket to the tour of your dreams. A whole new level of adventure awaits thanks to the "winding roads" route option, "avoid motorways" feature and the "round trip" function, which configures journeys based on time, distance or stopover. The circular polarization filter (CPOL) on the display minimizes reflection and improves contrast, ensuring the screen is easy to read, even in direct sunlight. 16GB of flash storage, and the ability to stream music from your smartphone, are the ultimate luxury.

Thanks to Bluetooth® technology, the sophisticated BMW Motorrad Navigator Street (with easy-to-read 4.3" display) is compatible with the optional BMW Motorrad communication system and comes with a host of handy features.

BMW Motorrad navigation devices and the BMW Motorrad smartphone cradle can only be mounted using the BMW Motorrad navigation device bracket.

For more detailed information, contact your BMW Motorrad dealership or go online at [bmw-motorrad.com](http://bmw-motorrad.com).

#### ITEM NUMBERS

**BMW Motorrad Navigator VI with mount cradle**  
(with map data for Europe)  
Order number: 77 52 8 355 749\*

**BMW Motorrad Navigator VI (without map data)**  
Order number: 77 52 8 356 005\*

(+) 4-button cradle mount  
Order number: 77 52 8 544 464\*

**BMW Motorrad Navigator Street**  
Order number: 77 52 8 557 855\*

**Bracket for BMW Motorrad navigation devices**  
Order number: 77 52 8 356 871\*

(+) Decoupling sleeve (four required)  
Order number: 65 90 8 535 827\*

(+) Cable tie  
Order number: 61 13 1 367 599\*

### MOBILE PHONE ADAPTER FOR STORAGE COMPARTMENT (NOT SHOWN)

Keeps your mobile phone and other small items safe and secure. Can be combined with the BMW USB charger and used for charging mobile phones while you're on the move. Waterproof and lockable.

#### ITEM NUMBERS

**Mobile phone adapter for storage compartment**  
Order number: 77 31 8 527 377\*

### BMW USB CHARGER (NOT SHOWN)

For charging compatible mobile phones while you're on the move. For operating and charging mobile phones and consumer electronic devices via USB interface or standard power socket.

#### PART NUMBERS

**BMW USB charger**  
Order number: 65 41 2 166 411\*

**BMW dual USB charger**  
Order number: 65 41 2 166 420\*

\* Original BMW Motorrad equipment is available from your BMW Motorrad dealer.



# SAFETY

## LED INDICATORS

Cutting-edge design inside and out. The LED indicators deliver reduced energy consumption and significantly longer bulb life – a shining example of efficiency. To be fitted and/or enabled in a specialist workshop, and ideally at your BMW Motorrad dealership.



### PART NUMBERS

**LED indicators, front, left** (image 1)

Order number: 63 13 7 725 167\*

(+) **LED indicators, front, right**

Order number: 63 13 7 725 168\*

**LED indicators, rear (two required)** (image 2)

Order number: 63 13 8 522 499\*



## SCOOTER LOCK

The scooter lock ensures that the maxi-scooter stays exactly where it was left. For example, the end of the handlebars can be secured using the swing arm or an immovable object.

To be fitted and/or enabled in a specialist workshop, and ideally at your BMW Motorrad dealership.

Use of chrome-plated handlebar weight is restricted when scooter lock is fitted (scooter lock fastener takes the place of left handlebar weight).

Model shown: BMW C 650 GT, 2015.

### PART NUMBERS

**Scooter lock**

Order number: 77 25 8 527 047\*

(+) **M12 x 50 screw (one required)**

Order number: 07 12 9 906 088\*

## ANTI-THEFT ALARM SYSTEM (NOT SHOWN)

If the motorcycle is moved or struck violently, the system responds with a clearly audible signal and a flashing warning light.

To be fitted and/or enabled in a specialist workshop, and ideally at your BMW Motorrad dealership.

### PART NUMBERS

**Anti-theft alarm system**

Order number: 77 53 8 554 348\*

(+) **Bracket for anti-theft alarm system**

Order number: 77 53 8 525 488\*

(+) **Clip nut (one required)**

Order number: 07 14 8 541 623\*

(+) **Raised head screw (three required)**

Order number: 06 32 7 651 203\*

(+) = "and" – this item must be ordered at the same time  
 (o) = "or" – this item may be ordered as an alternative option



\* Original BMW Motorrad equipment is available from your BMW Motorrad dealer.

## EQUIPMENT FOR THE BMW C EVOLUTION.



## STORAGE

### TOP BOX (35L) WITH BACKREST PAD

The waterproof top box with lid trims in Ionic Silver Metallic is mounted on the optional luggage grid. The optional backrest pad offers additional comfort for the pillion passenger.  
Only available in conjunction with luggage grid.  
For information on speed and load limitations, please refer to the instruction booklet.

#### PART NUMBERS

##### Top box, 35 l

Order number: 77 43 8 542 047\*

Lid trim, left, Ionic Silver Metallic  
Order number: 77 43 8 354 019\*

Lid trim, right, Ionic Silver Metallic  
Order number: 77 43 8 354 020\*

(+) Locking cylinder (with codes) for central locking with motorcycle  
Order number: 77 44 8 542 498\*

(o) Repair kit for locking cylinder  
Order number: 51 25 8 546 428\*

**Backrest pad for top box (35 l)**  
Order number: 77 44 8 527 002\*



(+) = "and" – this item must be ordered at the same time  
(o) = "or" – this item may be ordered as an alternative option



### INNER BAG FOR TOP BOX 35l

The practical, rigid inner bag with waterproof main compartment keeps its contents well protected. The capacity of the top box is fully utilized, and loading and unloading can be accomplished quickly and easily.  
For information on speed and load limitations, please refer to the instruction booklet.

#### PART NUMBER

**Inner bag for top box**  
Order number: 77 43 8 527 035\*

### LUGGAGE GRID

The sturdy, stylish luggage grid is ideal for securing the top box or other large items of luggage.  
To be fitted and/or enabled in a specialist workshop, and ideally at your BMW Motorrad dealership.

#### PART NUMBERS

##### Luggage grid

Order number: 77 44 8 564 067\*

(+) Trim for luggage grid frame, left  
Order number: 77 31 8 543 095\*

(+) Trim for luggage grid frame, right  
Order number: 77 31 8 543 096\*

(+) Washer 8-200 (two required)  
Order number: 07 11 9 904 826\*



\* Original BMW Motorrad equipment is available from your BMW Motorrad dealer.

## ERGONOMICS & COMFORT

### TOURING WINDSHIELD

The higher touring windshield provides improved protection against the elements. With scratch-resistant coating for durability and unimpeded visibility.

#### PART NUMBER

**Touring windshield**  
Order number: 77 33 8 545 707\*



### HEATED GRIPS AND SWITCHES

Warm hands feel good, with heated grips that come with two settings.

For more detailed information, contact your BMW Motorrad dealership or go online at [bmw-motorrad.com](http://bmw-motorrad.com).

To be fitted and/or enabled in a specialist workshop, and ideally at your BMW Motorrad dealership.



### COMFORT SEAT

The comfort seat provides a more relaxed seating position.

### COVER

Snug and waterproof yet breathable, this cover protects your maxi-scooter from rain, dirt and more. Made of tear-resistant, UV-resistant material.

#### PART NUMBER

**Cover**  
Order number: 77 34 8 527 017\*



(+) = "and" – this item must be ordered at the same time  
(o) = "or" – this item may be ordered as an alternative option

## NAVIGATION



### BMW MOTORRAD SMARTPHONE CRADLE

Now you can charge your phone out on the road with BMW Motorrad's waterproof smartphone cradle. Charging takes place wirelessly or via a plug-in connection. The display and navigation functions are perfectly positioned in your field of vision and can be easily operated from the cradle. For smartphones with 5" displays or smaller. Max. dimensions: 13.8 cm x 7.3 cm x 1.1 cm. Only in combination with bracket for BMW Motorrad navigation devices.

#### PART NUMBER

**BMW Motorrad smartphone cradle**  
Order number: 77 52 8 563 125\*

\* Original BMW Motorrad equipment is available from your BMW Motorrad dealer.



### BMW MOTORRAD NAVIGATION SYSTEMS

Where am I? Where do I want to go, and what's the most scenic way to get there?

BMW Motorrad navigation devices show you where to go. Made specifically for motorcyclists, they're easy to fit and use – even with gloves on – and come with lifetime map updates.

The new BMW Motorrad Navigator VI is your ticket to the tour of your dreams. A whole new level of adventure awaits thanks to the "winding roads" route option, "avoid motorways" feature and the "round trip" function, which configures journeys based on time, distance or stopover. The circular polarization filter (CPOL) on the display minimizes reflection and improves contrast, ensuring the screen is easy to read, even in direct sunlight. 16 GB of flash storage, and the ability to stream music from your smartphone, are the ultimate luxury.

BMW Motorrad navigation devices and the BMW Motorrad smartphone cradle can only be mounted using the BMW Motorrad navigation device bracket.

For more detailed information, contact your BMW Motorrad dealership or go online at [bmw-motorrad.com](http://bmw-motorrad.com).

#### ITEM NUMBERS

**BMW Motorrad Navigator VI with cradle mount**(with map data for Europe, top image)  
Order number: 77 52 8 355 749\*

**BMW Motorrad Navigator VI** (without map data)  
Order number: 77 52 8 356 005\*

(+) 4-button cradle mount  
Order number: 77 52 8 544 464\*

**BMW Motorrad Navigator Street** (bottom image)  
Order number: 77 52 8 557 855\*

**Bracket for BMW Motorrad navigation devices**  
Order number: 77 52 8 357 956\*

**Car mounting kit for Navigator VI**  
Order number: 77 52 8 544 460\*

## SAFETY



### ASPHERICAL MIRROR

The curved surface of the aspherical mirror increases the range of vision, almost completely eliminating blind spots when correctly adjusted.

Model shown: C 650 GT, 2015.

To be fitted and/or enabled in a specialist workshop, and ideally at your BMW Motorrad dealership.

#### PART NUMBERS

##### Aspherical mirror, left

Order number: 77 31 8 527 285\*

(+) Aspherical mirror, right

Order number: 77 31 8 527 286\*

### ANTI-THEFT ALARM SYSTEM (NOT SHOWN)

If the motorcycle is moved or struck violently, the system responds with a clearly audible signal and a flashing warning light.

To be fitted and/or enabled in a specialist workshop, and ideally at your BMW Motorrad dealership.

#### PART NUMBERS

##### Anti-theft alarm system

Order number: 77 53 8 554 348\*

(+) Cylinder screw M6x8 (one required)

Order number: 07 12 9 907 403\*

(+) C-clip nut, self-locking (one required)

Order number: 07 14 7 286 036\*

## MAINTENANCE AND TECHNOLOGY

### AC QUICK-CHARGE CABLE

Suitable for public charging stations and 16-A AC wall boxes, the AC quick-charge cable reduces charging time by up to 25% and can be stored securely under the seat. Available with 3 ECE standard plugs

Please check your local infrastructure in advance.



#### PART NUMBERS

##### CEE AC quick-charge cable

Order number: 61 44 7 649 991\*

##### Type 2 AC quick-charge cable

Order number: 77 50 8 560 644\*

##### Type 3 AC quick-charge cable

Order number: 77 50 8 563 723\*



\* Original BMW Motorrad equipment is available from your BMW Motorrad dealer.



**YOUR QUEST  
LIES NOT IN  
SETTLING DOWN  
BUT IN  
FINDING YOUR OWN  
PATH  
TO HAPPINESS**

F 800 GT	74
R 1200 RT	84
K 1600 GT	94
K 1600 GTL	104
K 1600 B	114
K 1600 GA	122



# TOUR

## EQUIPMENT FOR THE BMW F 800 GT.



## HP PARTS



### HP SPORT SILENCER

Made entirely out of titanium and stainless steel and to an exceptional level of craftsmanship, this slip-on silencer delivers a powerful rumble. It's also remarkably lightweight.

To be fitted and/or enabled in a specialist workshop, and ideally at your BMW Motorrad dealership.

Mounting instructions are available from your BMW Motorrad dealership.

#### PART NUMBER

**HP sport silencer**  
Order number: 77 11 8 567 783\*

(+) = "and" – this item must be ordered at the same time  
(o) = "or" – this item may be ordered as an alternative option

## STORAGE

### TOURING PANNIERS

Sturdy, splash-proof touring panniers with a total capacity of 55 l (27 l left, 28 l right) per 10 kg load. The right pannier has space for one helmet. Smart design for easy loading and unloading.

#### PART NUMBERS

**Touring pannier, left**  
Order number: 77 41 8 529 893\*

**Touring pannier, right**  
Order number: 77 41 8 529 894\*

(+) Mounting kit (two required)  
Order number: 71 60 7 680 840\*

(+) Locking cylinder (with codes) for central locking with motorcycle (two required)  
Order number: 51 25 7 681 200\*

(o) Repair kit for locking cylinder  
Order number: 51 25 7 698 204\*



### PANNIER RACKS

These sturdy pannier racks blend in perfectly with the vehicle's overall concept, providing a firm, secure hold for the touring panniers quickly and easily.

#### PART NUMBER

**Pannier racks**  
Order number: 71 60 7 719 744\*

### SPORT PANNIERS

The capacity of the sport panniers can be adjusted (15–25 l per pannier). The waterproof inside pockets are built into the system. The complete pannier set (pannier rack and luggage grid) can be quickly secured to and removed from the rack system.

#### PART NUMBERS

**Sport pannier, left**  
Order number: 71 60 7 719 740\*

**Sport pannier, right**  
Order number: 71 60 7 722 364\*

(+) Mounting kit (two required)  
Order number: 71 60 7 680 840\*

(+) Locking cylinder (with codes) for central locking with motorcycle (two required)  
Order number: 51 25 7 681 200\*

(o) Repair kit for locking cylinder  
Order number: 51 25 7 698 204\*

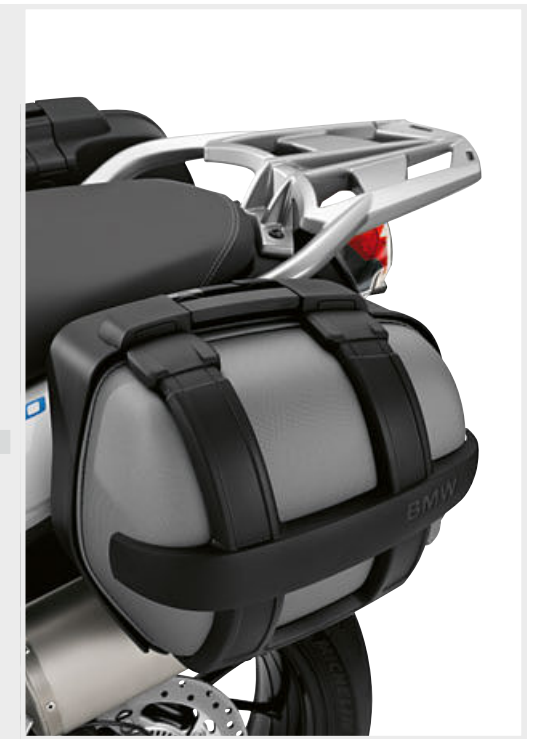

\* Original BMW Motorrad equipment is available from your BMW Motorrad dealer.



**TANKBAG**

The tankbag sits snugly on the tank without obstructing the rider's view of the BMW Motorrad Navigator. The waterproof main compartment is expandable from 10 to 14l. The tankbag also includes a highly water-resistant map pocket.

**PART NUMBER**

**Tankbag**  
Order number: 77 45 8 534 702\*



**TANKBAG**

This tankbag has a large waterproof main compartment (approx. 12 l) and a pocket (with window) for smaller items. It fits various BMW Motorrad models and can be combined with BMW Motorrad Navigator systems.

**ITEM NUMBERS**

**Tankbag**  
Order number: 71 60 7 691 391\*  
(+) Tankbag mounting kit  
Order number: 71 60 7 699 045\*



**UNIVERSAL TANKBAG**

A waterproof tankbag with waterproof main compartment and a small map pocket. Fits various BMW Motorrad models. Its capacity can be expanded from approximately 10 l to 12 l. Can be combined with BMW Motorrad Navigator systems.

**ITEM NUMBERS**

**Universal tankbag**  
Order number: 77 49 7 726 994\*  
(+) Universal tankbag attachment  
Order number: 77 49 8 520 292\*



**INNER BAGS FOR TOURING PANNIERS**

These practical, water-resistant inner bags make full use of the capacity of the touring panniers. Luggage can be accessed easily with one hand, and the bag can even be worn over the shoulder thanks to a detachable strap.

**PART NUMBERS**

**Inner bag for touring pannier, left**  
Order number: 77 49 8 534 714\*  
**Inner bag for touring pannier, right**  
Order number: 77 49 8 534 715\*



**INNER BAG FOR SMALL TOP BOX, 28 L**

Makes loading and unloading a top box even easier. Also comes with a practical carry handle.

**PART NUMBER**

**Inner bag for small top box**  
Order number: 71 60 7 680 541\*

**SMALL TOP BOX (28 l) WITH BACKREST PAD**

The waterproof top box holds one helmet with space to spare. It's quick and easy to mount onto the luggage grid, and with the optional backrest pad, it provides increased comfort for the pillion passenger.

**PART NUMBERS**

**Small waterproof top box, 28 l**  
Order number: 77 43 7 724 352\*  
To be fitted and/or enabled in a specialist workshop, and ideally at your BMW Motorrad dealership.  
(+) Locking cylinder with key  
Order number: 51 25 7 688 957\*  
(+) Locking cylinder (with codes) for central locking with motorcycle  
Order number: 51 25 7 681 200\*  
**Backrest pad for small top box**  
Order number: 71 60 7 693 672\*



\* Original BMW Motorrad equipment is available from your BMW Motorrad dealer.

(+) = "and" – this item must be ordered at the same time  
(o) = "or" – this item may be ordered as an alternative option

## DESIGN



### LED REAR LIGHT

Bright and energy-efficient. To be fitted and/or enabled in a specialist workshop, and ideally at your BMW Motorrad dealership.

#### PART NUMBERS

##### LED rear light

Order number: 63 21 7 714 557\*

(o) LED rear light (USA)

Order number: 63 21 7 714 558\*

(+) Adapter kit for LED rear light

Order number: 71 60 7 723 027\*

(+) Cable harness for LED rear light

Order number: 61 11 8 532 308\*

(o) Cable harness for LED rear light (USA)

Order number: 61 11 8 532 309\*

### REAR MUDGUARD (NOT SHOWN)

Helps protect the rear from dirt on wet surfaces.

#### PART NUMBER

##### Rear mudguard

Order number: 71 60 7 694 184\*

### LED INDICATORS

Cutting-edge design inside and out. The LED indicators complement the design of the BMW F 800 GT perfectly – and thanks to reduced energy consumption and significantly longer bulb life, they're also a shining example of efficiency.

To be fitted and/or enabled in a specialist workshop, and ideally at your BMW Motorrad dealership.

#### ITEM NUMBERS

**LED indicators, front** (two required)

Order number: 63 13 8 522 499\*

**LED indicators, rear** (two required)

Order number: 63 23 8 522 500\*

## ERGONOMICS & COMFORT

### TINTED WINDSHIELD

The sleek, tinted windshield provides effective protection against wind and rain.

#### PART NUMBER

##### Tinted windshield

Order number: 77 33 8 523 924\*



### HIGH WINDSHIELD

14 cm higher than the standard version, this windshield (with matt GT logo) is an even better way to keep out the wind and rain. With scratch-resistant coating for durability and unimpeded visibility.

#### PART NUMBER

##### High windshield

Order number: 46 63 8 559 918\*



### COMFORT SEATS

Wider and with extra padding, this seat (height: 820 mm) provides greater comfort on long tours. The high comfort seat (height: 845 mm, not shown) ensures the optimum knee angle for taller riders.

#### ITEM NUMBERS

##### Comfort seat

(seat height: 820 mm; step length: 1,858 mm)

Order number: 52 53 8 528 623\*

**High comfort seat** (not shown)

(seat height: 845 mm; step length: 1,910 mm)

Order number: 77 34 8 544 479\*



### SEATS

Low seat variants make it easy to climb on and ensure riders find the optimal knee angle for maximum control. 765-mm version also available as an option ("Low seat, Black")

#### PART NUMBERS

**Low seat, Black** (not shown)

(seat height: 785 mm; step length: 1,785 mm)

Order number: 52 53 8 554 097\*

**Extra low seat, Black**

(seat height: 765 mm; step length: 1,755 mm)

Order number: 52 53 8 554 099\*





### CENTRE STAND

The sturdy centre stand ensures that the bike remains stable even on loose surfaces.

#### PART NUMBERS

##### Centre stand

Order number: 46 52 8 552 109\*

(+) Centre stand attachment

Order number: 77 25 8 524 477\*



### HEATED GRIPS AND SWITCHES

Warm hands feel good, which is why these heated handlebar grips have two settings designed to keep hands and fingers pleasantly warm.

For more detailed information, contact your BMW Motorrad dealership or go online at [bmw-motorrad.com](http://bmw-motorrad.com).

To be fitted and/or enabled in a specialist workshop, and ideally at your BMW Motorrad dealership.



(+) = "and" – this item must be ordered at the same time  
(o) = "or" – this item may be ordered as an alternative option

## NAVIGATION AND COMMUNICATIONS.



### BMW MOTORRAD NAVIGATION SYSTEMS

Where am I? Where do I want to go, and what's the most scenic way to get there? BMW Motorrad navigation devices show you where to go. Made specifically for motorcyclists, they're easy to fit and use – even with gloves on – and come with lifetime map updates.

The new BMW Motorrad Navigator VI is your ticket to the tour of your dreams.

A whole new level of adventure awaits thanks to the "winding roads" route option, "avoid motorways" feature and the "round trip" function, which configures journeys based on time, distance or stopover. The circular polarization filter (CPOL) on the display minimizes reflection and improves contrast, ensuring the screen is easy to read, even in direct sunlight. 16 GB of flash storage, and the ability to stream music from your smartphone, are the ultimate luxury.

For more detailed information, contact your BMW Motorrad dealership or go online at [bmw-motorrad.com](http://bmw-motorrad.com).

#### ITEM NUMBERS

**BMW Motorrad Navigator VI with cradle mount** (with map data for Europe) (see image, right)  
Order number: 77 52 8 355 749\*

**BMW Motorrad Navigator VI** (without map data)  
Order number: 77 52 8 356 005\*

(+) 4-button cradle mount  
Order number: 77 52 8 544 464\*

(o) **BMW Motorrad Navigator Street** (see image, left)  
Order number: 77 52 8 557 855\*

**Bracket for BMW Motorrad navigation devices**  
Order number: 77 52 8 529 421\*

(+) Mounting screw (four required)  
Order number: 32 71 7 652 161\*

### BMW MOTORRAD SMARTPHONE CRADLE

Now you can charge your phone out on the road with BMW Motorrad's waterproof smartphone cradle. Charging takes place wirelessly or via a plug-in connection. The display and navigation functions are perfectly positioned in your field of vision and can be easily operated from the cradle. For smartphones with 5" displays or smaller. Max. dimensions: 13.8 cm x 7.3 cm x 1.1 cm.

#### PART NUMBERS

**BMW Motorrad smartphone cradle**  
Order number: 77 52 8 563 125\*

**Bracket for BMW Motorrad navigation devices**  
Order number: 77 52 8 529 421\*

(+) Mounting screw (four required)  
Order number: 32 71 7 652 161\*



\* Original BMW Motorrad equipment is available from your BMW Motorrad dealer.

## SAFETY

### **ANTI-THEFT ALARM SYSTEM WITH REMOTE CONTROL**

If the motorcycle is moved or struck violently, the system responds with a clearly audible signal and a flashing warning light. Easy to operate remotely.

To be fitted and/or enabled in a specialist workshop, and ideally at your BMW Motorrad dealership.

Mounting instructions are available from your BMW Motorrad dealership.



#### **PART NUMBERS**

##### **Anti-theft alarm system with remote control**

Order number: 77 53 8 545 003\*

(+) Bracket for anti-theft alarm system

Order number: 65 75 7 718 385\*

### **ASC (AUTOMATIC STABILITY CONTROL), SWITCHABLE**

Controls and optimizes transmission and prevents rear wheel spin – on wet surfaces, for example. For more detailed information, contact your BMW Motorrad dealership or go online at [bmw-motorrad.com](http://bmw-motorrad.com).

To be fitted and/or enabled in a specialist workshop, and ideally at your BMW Motorrad dealership.



## EQUIPMENT FOR THE BMW R 1200 RT.



## HP PARTS



### HP SPORT SILENCER

Top-grade parts for top-quality sound: made entirely of titanium, with laser-etched logo, carbon end cap and heat shield. The HP sport silencer turns every ride into a thrilling experience. Approx. 1.1 kg lighter than the standard silencer.

For more detailed information, contact your BMW Motorrad dealership or go online at [bmw-motorrad.com](http://bmw-motorrad.com).

#### PART NUMBER

**HP sport silencer**  
Order number: 77 11 8 392 780\*

(+) = "and" – this item must be ordered at the same time  
(o) = "or" – this item may be ordered as an alternative option

## STORAGE



### SMALL TOP BOX I AND BACKREST PAD

Small, waterproof top box with a capacity of 28 l (space for one helmet). A backrest pad and central locking functionality are also available upon request. It can be secured quickly and easily to the standard luggage grid. For information on speed and load limitations, please refer to the instruction booklet.

#### ITEM NUMBERS

##### Small waterproof top box, 28 l

Order number: 77 43 7 724 352\*

(+) Locking cylinder (with codes) for central locking with motorcycle

Order number: 51 25 7 681 200\*

(o) Repair kit for locking cylinder

Order number: 51 25 7 698 204\*

##### Backrest pad for small top box

Order number: 71 60 7 693 672\*

### TOP BOX (LIGHT/LARGE, FULLY EQUIPPED)

Large, waterproof top box (capacity: 49 l) and a backrest pad fitted as standard. It can be secured quickly and easily to the standard luggage grid. Central locking functionality is also available upon request.

For information on speed and load limitations, please refer to the instruction booklet.

#### ITEM NUMBERS

##### Light top box, White Aluminium, 49 l

Order number: 77 43 8 544 630\*

Does not include electrics, central locking, inside light or carpet lining.

##### Large top box, fully equipped, White Aluminium, 49 l

Order number: 77 43 8 544 631\*

To be fitted and/or enabled in a specialist workshop, and ideally at your BMW Motorrad dealership.

Only available with option code 0417: central locking

(+) Locking cylinder (with codes) for central locking with motorcycle

Order number: 51 25 7 681 200\*

(o) Repair kit for locking cylinder

Order number: 51 25 7 698 204\*



\* Original BMW Motorrad equipment is available from your BMW Motorrad dealer.

### INNER BAG FOR TOP BOX

The handy, high-quality inner bag is water-resistant and makes full use of the capacity of the top box. So while the inner bag is being used, space within the storage compartment for the top box will be limited.

#### PART NUMBER

##### Inner bag for top box

Order number: 77 41 8 520 301\*





**INNER BAGS FOR TOURING PANNIERS**

The tough inner bags make it easier to load and unload the panniers, and are also water-resistant. The practical interior has dividers for holding items in place, and the outer pockets are ideal for small items. With carry handles and detachable shoulder strap.

**PART NUMBERS**

- Inner bag for touring pannier, left**  
Order number: 77 41 8 520 295\*
- Inner bag for touring pannier, right**  
Order number: 77 41 8 520 296\*



**INNER BAG FOR SMALL TOP BOX, 28 L**

Makes loading and unloading a top box even easier. Also comes with a practical carry handle making it easy to access and transport.

**PART NUMBERS**

- Inner bag for small top box**  
Order number: 71 60 7 680 541\*
- Backrest pad for small top box**  
Order number: 71 60 7 693 672\*

**IMPACT PROTECTION SYSTEM FOR TOURING PANNIER (NOT SHOWN)**

Made of sturdy plastic, protects top, bottom and sides of panniers.  
To be fitted and/or enabled in a specialist workshop, and ideally at your BMW Motorrad dealership.

**ITEM NUMBER**

- Impact protection system for touring pannier, left**  
Order number: 77 42 7 700 461\*
- Impact protection system for touring pannier, right**  
Order number: 77 42 7 700 462\*

**PROTECTIVE FILM FOR TOURING PANNIER (NOT SHOWN)**

Self-adhesive, transparent, protects top and sides of panniers and prevents unsightly scratches.

**ITEM NUMBER**

- Protective film for touring panniers (one required)**  
Order number: 77 42 8 528 355\*

**PART NUMBER**

- Tankbag**  
Order number: 77 45 8 543 227\*

**TANKBAG**

The lockable main compartment is waterproof and has a capacity of 11 l. The map compartment is highly water-resistant. The water-repellent exterior pocket securely holds a 0.5-l PET bottle. With carry handle and detachable shoulder strap.  
For information on speed and load limitations, please refer to the instruction booklet.



**STORAGE COMPARTMENT FOR TOP BOX**

The perfect solution for documents, stationery or even your tablet: this handy compartment has four quick-release fasteners for attaching to the lid of the top box, and helps keep things tidy while providing ready access to all your vital bits and pieces.

**PART NUMBER**

- Storage compartment for top box**  
Order number: 77 41 8 520 303\*



**ADDITIONAL BRAKE LIGHT FOR TOP BOX (FULLY EQUIPPED)**

The clear-glass LED additional brake light enhances passive safety and blends perfectly into the existing top box lid cover.  
To be fitted and/or enabled in a specialist workshop, and ideally at your BMW Motorrad dealership.

**PART NUMBER**

- Additional brake light for top box**  
Order number: 77 51 8 520 044\*



\* Original BMW Motorrad equipment is available from your BMW Motorrad dealer.

(+) = "and" – this item must be ordered at the same time  
(o) = "or" – this item may be ordered as an alternative option

## DESIGN

### CHROME PARTS

Choose the look you want: these elegant, high-quality chrome parts can be combined as you wish, giving your BMW R 1200 RT a unique, stylish edge. To be fitted and/or enabled in a specialist workshop, and ideally at your BMW Motorrad dealership.

### ITEM NUMBERS

**Pannier trim, left, chrome-plated** (image 1)  
Order number: 51 14 8 545 123\*

**Pannier trim, right, chrome-plated**  
Order number: 51 14 8 545 124\*

**Top box lid trim, chrome-plated** (image 2)  
Order number: 46 54 8 522 938\*

**Chrome-plated silencer** (image 3)  
Order number: 18 51 8 531 078\*



## ERGONOMICS & COMFORT



### HIGH RIDER SEAT, BLACK

The adjustable high rider seat (seat height: 830 / 850 mm / step length: 1,875 / 1,915 mm) optimizes the angle of the knee for taller riders and increases comfort on longer journeys. Seat heating available upon request. Also available as an equipment option.

### PART NUMBERS

**High rider seat, Black**  
Order number: 52 53 8 544 778\*

(o) High rider seat with seat heating, Black  
Order number: 52 53 8 544 792\*  
Heating function for seat only available as part of the "Seat heating" equipment option. Varying levels of foam density and a Freshtouch seat cover increase comfort.

### LOW RIDER SEAT, BLACK

This rider seat can be lowered by 45 mm (seat height: 760 / 780 mm, step length: 1,740/1,780 mm), making climbing on and handling easier. Seat heating available upon request.

### PART NUMBERS

**Low rider seat, Black**  
Order number: 52 53 8 544 780\*

(o) Low rider seat with seat heating, Black  
Order number: 52 53 8 544 786\*  
Heating function for seat only available as part of the "Seat heating" equipment option. Varying levels of foam density and a Freshtouch seat cover increase comfort.



\* Original BMW Motorrad equipment is available from your BMW Motorrad dealer.



**PRO GEAR-SHIFT ASSIST**

Change gears without using the clutch. To be fitted and/or enabled in a specialist workshop, and ideally at your BMW Motorrad dealership.

**PART NUMBERS**

**Pro gear-shift assist**  
Order number: 23 41 8 536 884\*  
(+) Enabling code for Pro gear-shift assist  
Order number: 13 61 8 545 879\*



**COMFORT WINDSHIELD**

Higher and wider than the standard version, this windshield ensures optimum touring comfort in all kinds of weather. The aeroacoustics are outstanding, and scratch-resistant coating guarantees unimpeded visibility. To be fitted and/or enabled in a specialist workshop, and ideally at your BMW Motorrad dealership.

**CRUISE CONTROL (NOT SHOWN)**

Also available as an equipment option. To be fitted and/or enabled in a specialist workshop, and ideally at your BMW Motorrad dealership. For more detailed information, contact your BMW Motorrad dealership or go online at [bmw-motorrad.com](http://bmw-motorrad.com).

**PART NUMBER**

**Comfort windshield**  
Order number: 77 33 8 543 540

**RIDER SEAT, BLACK (NOT SHOWN)**

Seat height: 805 / 825 mm / step length: 1,810 / 1,850mm

**PART NUMBERS**

**Rider seat, Black**  
Order number: 52 53 8 544 782\*  
(o) Rider seat with seat heating, Black  
Order number: 52 53 8 544 784\*

**Pillion seat, Black**  
Order number: 52 53 8 544 788\*

**Pillion seat with seat heating, Black**  
Order number: 52 53 8 544 790

Heating function for seat only available as part of the "Seat heating" equipment option. Varying levels of foam density and a Freshtouch seat cover increase comfort.

**NAVIGATION AND COMMUNICATIONS.**



**BMW MOTORRAD NAVIGATION SYSTEMS**

Where am I? Where do I want to go, and what's the most scenic way to get there? BMW Motorrad navigation devices show you where to go. Made specifically for motorcyclists, they're easy to fit and use – even with gloves on – and come with lifetime map updates.

The new BMW Motorrad Navigator VI is your ticket to the tour of your dreams.

A whole new level of adventure awaits thanks to the "winding roads" route option, "avoid motorways" feature and the "round trip" function, which configures journeys based on time, distance or stopover. The circular polarization filter (CPOL) on the display minimizes reflection and improves contrast, ensuring the screen is easy to read, even in direct sunlight. 16 GB of flash storage, and the ability to stream music from your smartphone, are the ultimate luxury.

Only available in conjunction with "Navigation device preparation" (also available as an equipment option, option code 272)

**ITEM NUMBERS**

**BMW Motorrad Navigator VI**  
(with map data for Europe)  
Order number: 77 52 8 355 994\*

**BMW Motorrad Navigator VI** (without map data)  
Order number: 77 52 8 356 005\*  
For more detailed information, contact your BMW Motorrad dealership or go online at [bmw-motorrad.com](http://bmw-motorrad.com).

(+) = "and" – this item must be ordered at the same time  
(o) = "or" – this item may be ordered as an alternative option

\* Original BMW Motorrad equipment is available from your BMW Motorrad dealer.

## SAFETY



### STAINLESS STEEL CYLINDER HEAD COVER GUARD

If the worst comes to the worst, the cylinder head cover guard provides comprehensive protection against damage. Plastic contact guard is replaceable.

#### PART NUMBER

**Cylinder head cover guard**  
Order number: 77 14 8 533 745\*



### SAFETY SCREW FOR OIL FILLER CAP

Small, yet refined: this small safety screw is made of milled aluminium and prevents unauthorized removal of the oil filler cap.

#### ITEM NUMBER

**Safety screw for oil filler cap**  
Order number: 71 60 7 696 117\*

### TPC (TYRE PRESSURE CONTROL) (NOT SHOWN)

Now with gradient monitoring, TPC from BMW Motorrad constantly monitors tyre pressure and provides riders with real-time updates. Riders are also alerted when there is any significant drop in pressure. Also available as an equipment option. To be fitted and/or enabled in a specialist workshop, and ideally at your BMW Motorrad dealership. For more detailed information, contact your BMW Motorrad dealership or go online at [bmw-motorrad.com](http://bmw-motorrad.com).

#### ITEM NUMBERS

**TPC, retrofit**  
Order number: 36 31 8 532 731\*  
(+) TPC control unit  
Order number: 65 75 8 546 222\*  
(+) Sign  
Order number: 71 21 7 698 971\*  
(+) Bolts  
Order number: 36 31 8 520 871\*

### PRO RIDING MODES ENABLING CODE (NOT SHOWN)

#### ITEM NUMBERS

**Pro riding modes enabling code**  
Order number: 13 61 8 534 237\*  
(+) Enabling code for DTC  
Order number: 13 61 8 550 119\*

### ANTI-THEFT ALARM SYSTEM (NOT SHOWN)

If the motorcycle is moved or struck violently, the system responds with a clearly audible signal and a flashing warning light. Also available as an equipment option with central locking. To be fitted and/or enabled in a specialist workshop, and ideally at your BMW Motorrad dealership.

#### PART NUMBER

**Anti-theft alarm system**  
Order number: 77 53 8 554 348\*



### LED AUXILIARY HEADLIGHTS

The LED auxiliary headlights deliver increased safety when visibility is poor, e.g. in fog, snow and rain. To be fitted and/or enabled in a specialist workshop, and ideally at your BMW Motorrad dealership. The auxiliary headlights are approved for use as fog lights, and may only be used in poor weather conditions. Country-specific road traffic regulations apply.

#### ITEM NUMBERS

**LED auxiliary headlights** (two required)  
Order number: 63 17 8 556 937\*  
(+) Bracket for auxiliary headlight, left  
Order number: 63 17 8 541 631\*  
(+) Bracket for auxiliary headlight, right  
Order number: 63 17 8 541 630\*  
(+) Cable harness for auxiliary headlights  
Order number: 61 12 8 394 716\*  
(+) Cylinder screw M6x40 (two required)  
Order number: 07 12 9 907 398\*  
(+) Hexagonal nut M6 (two required)  
Order number: 07 12 9 905 826\*  
(+) Cylinder screw M8x30 (two required)  
Order number: 07 12 9 907 381\*  
(+) Additional switch for auxiliary headlights  
Order number: 61 31 8 533 473\*  
(+) Body panel screw M5x14  
Order number: 07 12 9 907 413\*  
(+) Cable clamp  
Order number: 32 72 8 534 367\*



\* Original BMW Motorrad equipment is available from your BMW Motorrad dealer.

## EQUIPMENT FOR THE BMW K 1600 GT.



## HP PARTS

### HP SPORT SILENCER

Craftsmanship at its finest: A double-flow slip-on silencer with high-quality conical titanium casing, crossover pipes and mounting system made of stainless steel, plus end-cap made of carbon.

With three tailpipes on each side, the BMW K 1600 GT generates a rich, throaty sound to deliver a thrilling riding experience.

#### PART NUMBER

**HP sport silencer**  
Order number: 77 11 8 356 974\*



(+) = "and" – this item must be ordered at the same time  
(o) = "or" – this item may be ordered as an alternative option

## STORAGE



### TOP BOX IN BIKE COLOUR

The waterproof top box with build-in backrest pad for the pillion passenger has an interior light and a velours lining, and takes minimal effort to open. It has a capacity of approximately 49l – Available in all current vehicle colours (image: Light White).

#### PART NUMBERS

**Top box in Black Storm Metallic**  
Order number: 77 43 8 553 921\*

(o) Top box in Mars Red Metallic  
Order number: 77 43 8 565 872\*

(o) Top box in Lupin Blue Metallic  
Order number: 46 54 8 567 662\*

(+) Locking cylinder (with codes) for central locking with motorcycle  
Order number: 51 25 7 681 200\*

(o) Repair kit for locking cylinder  
Order number: 51 25 7 698 204\*

### INNER BAGS FOR TOURING PANNIERS

The tough inner bags make it easier to load and unload the panniers, and are also water-resistant. The practical interior has dividers for holding items in place, and the outer pockets are ideal for small items. With carry handles and detachable shoulder strap.



#### PART NUMBERS

**Inner bag for touring pannier, left**  
Order number: 77 41 8 520 295\*

**Inner bag for touring pannier, right**  
Order number: 77 41 8 520 296\*

### TANKBAG

The watertight main compartment of the tankbag can be expanded from 10l to 12 land features a small transparent window with a cradle for mobile phones. Also includes two exterior pockets and one interior pocket for stowing small items securely. With carry handle and detachable shoulder strap.



#### PART NUMBER

**Tankbag**  
Order number: 77 45 8 520 297\*

\* Original BMW Motorrad equipment is available from your BMW Motorrad dealer.





**IMPACT PROTECTION SYSTEM FOR TOURING PANNIERS**

Made of sturdy plastic, protects top, bottom and sides of panniers.  
To be fitted and/or enabled in a specialist workshop, and ideally at your BMW Motorrad dealership.

**ITEM NUMBER**

**Impact protection system for touring pannier, left**  
Order number: 77 42 7 700 461\*

**Impact protection system for touring pannier, right**  
Order number: 77 42 7 700 462\*



**ADDITIONAL BRAKE LIGHT FOR TOP BOX**

The clear-glass LED additional brake light enhances passive safety and blends perfectly into the existing top box lid cover.  
To be fitted and/or enabled in a specialist workshop, and ideally at your BMW Motorrad dealership.

**PART NUMBER**

**Additional brake light for top box**  
Order number: 77 51 8 520 044\*



**INNER BAG FOR TOP BOX**

The handy, high-quality inner bag is water-resistant and makes full use of the capacity of the top box. So while the inner bag is being used, space within the storage compartment for the top box will be limited.

**PART NUMBER**

**Inner bag for top box**  
Order number: 77 41 8 520 301\*



**STORAGE COMPARTMENT FOR TOP BOX**

The perfect solution for documents, stationery or even your tablet: this handy compartment has four quick-release fasteners for attaching to the lid of the top box, and helps keep things tidy while providing ready access to all your vital bits and pieces.

**PART NUMBER**

**Storage compartment for top box**  
Order number: 77 41 8 520 303\*

**PROTECTIVE FILM FOR TOURING PANNIER (NOT SHOWN)**

Self-adhesive, transparent, protects top and sides of panniers and prevents unsightly scratches.  
To be fitted and/or enabled in a specialist workshop, and ideally at your BMW Motorrad dealership.

**ITEM NUMBER**

**Protective film for touring panniers** (one required)  
Order number: 77 42 8 528 355\*

**DESIGN**

1



2



**OPTION 719 CLASSIC FORGED WHEELS**

The glossy, milled finish is where the nine-spoke aluminium-alloy forged wheels really shine.  
To be fitted and/or enabled in a specialist workshop, and ideally at your BMW Motorrad dealership.

**ITEM NUMBERS**

**Forged wheel, front**

Order number: 77 21 8 388 006\*

(+) Brake disc, front (two required)

Order number: 34 11 8 563 499\*

(+) Spacer tube

Order number: 36 31 7 676 141\*

(+) Shaft sealing ring (two required)

Order number: 36 31 8 561 710\*

(+) Grooved ball bearing (two required)

Order number: 36 31 8 531 207\*

(+) Bush bearing

Order number: 36 31 8 551 385\*

(+) Cylinder screw M8x25 (12 required)

Order number: 07 12 9 907 382\*

(+) Pulse wheel

Order number: 34 52 8 523 479\*

(+) Cylinder screw M5x6 (six required)

Order number: 07 12 9 907 842\*

(+) Angular valve

Order number: 36 31 8 542 009\*

(+) Nut

Order number: 36 31 8 542 010\*

**Forged wheel, rear**

Order number: 77 21 8 555 597\*

(+) Angular valve

Order number: 36 31 8 542 009\*

(+) Nut

Order number: 36 31 8 542 010\*

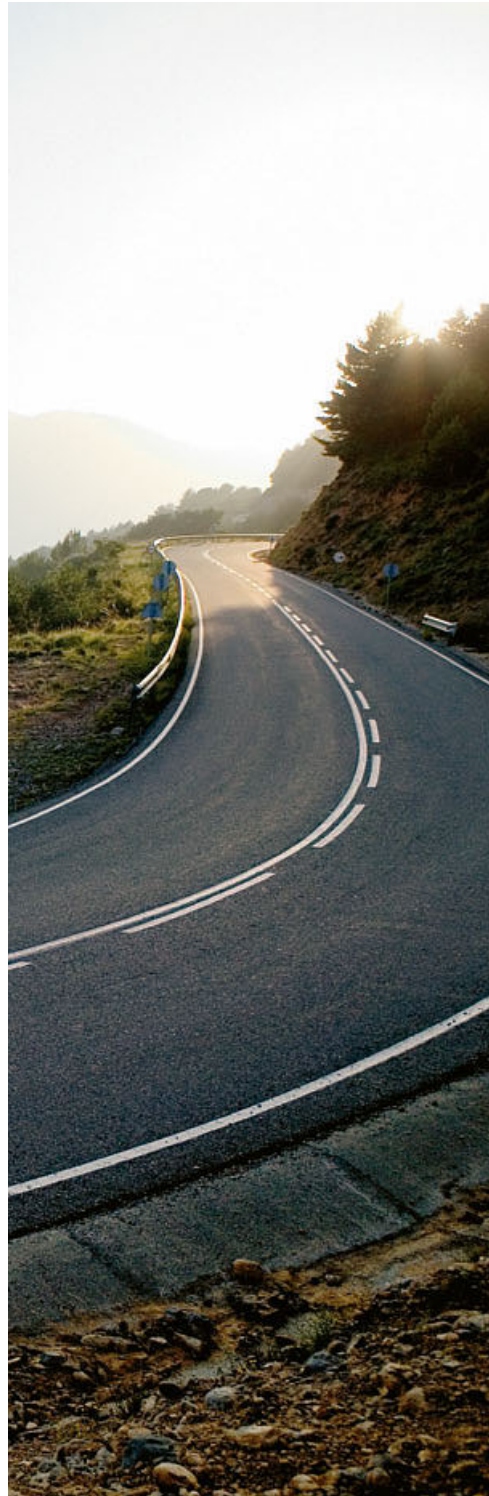

### GROUND-LEVEL LIGHTING

Getting late? Ground-level lighting illuminates the surface below your wheels with modern LED technology, making it easier to park. If desired, the function can remain active even after the ignition key is removed.

To be fitted and/or enabled in a specialist workshop, and ideally at your BMW Motorrad dealership.  
Only available in conjunction with option codes 603 and 417: anti-theft alarm system with central locking  
Not approved for all countries, observe the regulations applicable in your country.

#### PART NUMBER

**Ground-level lighting**  
Order number: 63 17 7 727 584\*

### CHROME PARTS

Choose the look you want: these elegant, high-quality chrome parts can be combined as you wish, giving your BMW R 1200 RT a unique, stylish edge.

To be fitted and/or enabled in a specialist workshop, and ideally at your BMW Motorrad dealership.

#### ITEM NUMBERS

**Pannier trim, left, chrome-plated** (image 1)  
Order number: 51 14 8 545 123\*

**Pannier trim, right, chrome-plated**  
Order number: 51 14 8 545 124\*

**Top box lid trim, chrome-plated** (image 2)  
Order number: 46 54 8 522 938\*

**Windshield trim, left, chrome-plated** (image 3)  
Order number: 46 63 7 727 403\*

**Windshield trim, right, chrome-plated**  
Order number: 46 63 7 727 404\*



## ERGONOMICS & COMFORT

### PRO GEAR-SHIFT ASSIST (NOT SHOWN)

Delivers smooth shifts without the use of the clutch. Also available as an equipment option.

To be fitted and/or enabled in a specialist workshop, and ideally at your BMW Motorrad dealership.

For more detailed information, contact your BMW Motorrad dealership or go online at [bmw-motorrad.com](http://bmw-motorrad.com).

#### ITEM NUMBER

**Pro gear-shift assist, retrofit**  
Order number: 23 41 8 545 533\*

(+) Enabling code for Pro gear-shift assist



### ONE-PIECE SEAT

Instantly inviting, this extra-wide seat features decorative stitching and all the padding you need, offering outstanding comfort for both rider and passenger when touring. Available in three seat heights. All retrofittable seats are heated. 780 mm and 810 mm seat heights are also available.

#### ITEM NUMBERS

**One-piece seat**  
(seat height: 780 mm/step length: 1,770 mm)  
Order number: 52 53 7 718 500\*

**Low one-piece seat**  
(see pages 4–5)  
(seat height: 750 mm/step length: 1,720 mm)  
Order number: 52 53 7 729 321\*

**High one-piece seat** (not shown)  
(seat height: 810 mm/step length: 1,830 mm)



### HEIGHT-ADJUSTABLE RIDER SEAT

The seat offers a dynamic profile without compromising on comfort. Adjustable between two height positions as necessary. Two versions with different seat heights are available

#### ITEM NUMBER

**Height-adjustable rider seat**  
(seat height: 780 mm / 800 mm / step length: 1,775/1,810 mm)  
Order number: 52 53 7 712 118\*

(o) High rider seat, height-adjustable (not shown)  
(seat height: 810 mm / 830 mm / step length: 1,830 / 1,870 mm)

Order number: 52 53 7 716 435\*

(+) Rider seat installation kit  
Order number: 77 34 8 520 028\*

(+) Pillion seat  
Order number: 52 53 7 712 119\*

(+) Connecting cable  
Order number: 61 12 8 528 423\*



### LOW WINDSHIELD

Gives the K 1600 GT a sleek, track-style look while protecting the rider against wind and rain.

To be fitted and/or enabled in a specialist workshop, and ideally at your BMW Motorrad dealership.

#### PART NUMBER

**Low windshield**  
Order number: 77 33 8 528 329\*

**SPORT RIDER SEAT  
(NOT SHOWN)**

**ITEM NUMBERS**

Sport rider seat, Stone Grey  
Order number: 52 53 8 546 818\*  
(+) Sport pillion seat, Stone Grey  
Order number: 52 53 8 546 819\*

**COMFORT RIDER SEAT  
(NOT SHOWN)**

**PART NUMBER**

**Comfort rider seat, Stone Grey**  
Order number: 52 53 8 546 825\*

**COMFORT WINDSHIELD  
(NOT SHOWN)**

The comfort windshield comes with anti-scratch coating and provides maximum protection against wind and rain for both rider and pillion passenger. 20 mm higher than the standard windshield (with the same width), it also offers outstanding aeroacoustics.

To be fitted and/or enabled in a specialist workshop, and ideally at your BMW Motorrad dealership.

**PART NUMBER**

**Comfort windshield**  
Order number: 77 33 7 724 350\*

**HILL START CONTROL  
(NOT SHOWN)**

Park or pull away on up or down gradients, even with a pillion passenger and heaps of luggage on board.

Also available as an equipment option.

To be fitted and/or enabled in a specialist workshop, and ideally at your BMW Motorrad dealership.

For more detailed information, contact your BMW Motorrad dealership or go online at [bmw-motorrad.com](http://bmw-motorrad.com)

**ITEM NUMBER**

**Hill Start Control**  
Order number: 77 23 8 536 874\*

**NAVIGATION AND  
COMMUNICATION**



**BMW MOTORRAD  
NAVIGATION SYSTEMS**

Where am I? Where do I want to go, and what's the most scenic way to get there? BMW Motorrad navigation devices show you where to go. Made specifically for motorcyclists, they're easy to fit and use – even with gloves on – and come with lifetime map updates.

The new BMW Motorrad Navigator VI is your ticket to the tour of your dreams.

A whole new level of adventure awaits thanks to the “winding roads” route option, “avoid motorways” feature and the “round trip” function, which configures journeys based on time, distance or stopover. The circular polarization filter (CPOL) on the display minimizes reflection and improves contrast, ensuring the screen is easy to read, even in direct sunlight. 16 GB of flash storage, and the ability to stream music from your smartphone, are the ultimate luxury.

For more detailed information, contact your BMW Motorrad dealership or go online at [bmw-motorrad.com](http://bmw-motorrad.com).

**ITEM NUMBERS**

**BMW Motorrad Navigator VI**  
(with map data for Europe)  
Order number: 77 52 8 355 994\*

**BMW Motorrad Navigator VI with cradle mount**  
(with map data for Europe, top image)  
Order number: 77 52 8 355 749\*

**BMW Motorrad Navigator VI** (without map data)  
Order number: Order number: 77 52 8 356 005\*

(+) 4-button cradle mount  
Order number: 77 52 8 544 464\*

**Enabling code for Bluetooth retrofit**  
Order number: 77 23 8 527 618\*

(+) Mounting screw (four required)  
Order number: 32 71 7 652 161\*  
To be fitted and/or enabled in a specialist workshop, and ideally at your BMW Motorrad dealership.  
Only available in conjunction with “audio system navigation device preparation” (option code 267).

## SAFETY



### ENGINE PROTECTION BAR

The tough two-piece engine protection bar is made of stainless steel with a bead-blasted matt finish. It protects the engine cover against serious impacts, while blending in perfectly with the stylish profile of the BMW K 1600 GT.

#### PART NUMBERS

**Engine protection bar, left**  
Order number: 77 14 7 700 463\*

**Engine protection bar, right**  
Order number: 77 14 7 700 464\*

### ANTI-THEFT ALARM SYSTEM (NOT SHOWN)

If the motorcycle is moved or struck violently, the system responds with a clearly audible signal and a flashing warning light. Also available as an equipment option with central locking.  
To be fitted and/or enabled in a specialist workshop, and ideally at your BMW Motorrad dealership.

#### PART NUMBER

**Anti-theft alarm system**  
Order number: 77 53 8 554 348\*

### LED AUXILIARY HEADLIGHTS

The LED auxiliary headlights deliver increased safety when visibility is poor, e.g. in fog, snow and rain. Also available as an equipment option.

To be fitted and/or enabled in a specialist workshop, and ideally at your BMW Motorrad dealership.

The auxiliary headlights are approved for use as fog lights, and may only be used in poor weather conditions. Country-specific road traffic regulations apply

#### ITEM NUMBER

**LED auxiliary headlights (two required)**  
Order number: 63 17 8 532 148\*

(+) Radiator trim, left headlight  
Order number: 46 63 8 569 061\*

(+) Radiator trim, right headlight  
Order number: 46 63 8 569 062\*

(+) Trim, left, Monolith Matt Metallic  
Order number: 46 63 8 568 915\*

(o) Trim, left, Black Storm Matt Metallic  
Order number: 46 63 7 708 647\*

(+) Trim, right, Monolith Matt Metallic  
Order number: 46 63 8 568 916\*

(o) Trim, right, Black Storm Matt Metallic  
Order number: 46 63 7 708 648\*

(+) Plug-in nut M5 (two required)  
Order number: 46 63 7 721 031\*

(+) Body panel screw M5x14 (two required)

Order number: 46 63 8 534 938\*

(+) Raised head screw M5x16 (four required)  
Order number: 06 32 7 657 949\*

(+) Upper clamping block (two required)  
Order number: 46 63 8 535 971\*

(+) Lower clamping block (two required)  
Order number: 46 63 8 535 972\*

(+) Body panel screw M5x14 (four required)  
Order number: 46 63 8 534 938\*

(+) Washer (two required)  
Order number: 63 17 7 723 678\*

(+) ISA screw M8x20 (two required)  
Order number: 07 12 9 904 065\*

(+) Angle bracket, left  
Order number: 46 63 8 557 419\*

(+) Angle bracket, right  
Order number: 46 63 8 557 420\*

(+) Body panel screw M5x14 (two required)  
Order number: 46 63 8 534 938\*

(+) Additional switch for auxiliary headlights  
Order number: 61 31 8 533 473\*

(+) Inner Torx screw M5x12  
Order number: 07 12 9 907 413\*



(+) = "and" – this item must be ordered at the same time  
(o) = "or" – this item may be ordered as an alternative option



\* Original BMW Motorrad equipment is available from your BMW Motorrad dealer.

## EQUIPMENT FOR THE BMW K 1600 GTL.



## HP PARTS

### HP SPORT SILENCER

Craftsmanship at its finest: A double-flow slip-on silencer with high-quality conical titanium casing, crossover pipes and mounting system made of stainless steel, plus end-cap made of carbon.

With three tailpipes on each side, the BMW K 1600 GTL generates a rich, throaty sound to deliver a thrilling riding experience.

Model shown: BMW K 1600 GT.

#### PART NUMBER

#### HP sport silencer

Order number: 77 11 8 356 974\*



(+) = "and" – this item must be ordered at the same time  
(o) = "or" – this item may be ordered as an alternative option

## STORAGE



### INNER BAGS FOR TOURING PANNIERS

The tough inner bags make it easier to load and unload the panniers, and are also water-resistant. The practical interior has dividers for holding items in place, and the outer pockets are ideal for small items.

With carry handles and detachable shoulder strap.



### IMPACT PROTECTION SYSTEM FOR TOURING PANNIERS

Made of sturdy plastic, protects top, bottom and sides of panniers

To be fitted and/or enabled in a specialist workshop, and ideally at your BMW Motorrad dealership.

### PROTECTIVE FILM FOR TOURING PANNIER (NOT SHOWN)

Self-adhesive and transparent, protects top and sides of panniers and prevents unsightly scratches.

To be fitted and/or enabled in a specialist workshop, and ideally at your BMW Motorrad dealership.

#### PART NUMBER

#### Protective film for touring panniers (one required)

Order number: 77 42 8 528 355\*

#### PART NUMBER

#### Inner bag for touring pannier, left

Order number: 77 41 8 520 295\*

#### Inner bag for touring pannier, right

Order number: 77 41 8 520 296\*

#### PART NUMBER

#### Impact protection system for touring pannier, left

Order number: 77 42 7 700 461\*

#### Impact protection system for touring pannier, right

Order number: 77 42 7 700 462\*



### ADDITIONAL BRAKE LIGHT FOR TOP BOX

The clear-glass LED additional brake light enhances passive safety and blends perfectly into the existing top box lid cover.

To be fitted and/or enabled in a specialist workshop, and ideally at your BMW Motorrad dealership.

#### PART NUMBER

#### Additional brake light for top box

Order number: 77 51 8 520 044\*

\* Original BMW Motorrad equipment is available from your BMW Motorrad dealer.



**INNER BAG FOR TOP BOX**

The handy, high-quality inner bag is water-resistant and makes full use of the capacity of the top box. While the inner bag is being used, space within the storage compartment for the top box will be limited.

**PART NUMBER**

**Inner bag for top box**  
Order number: 77 41 8 520 301\*



**STORAGE COMPARTMENT FOR TOP BOX**

The perfect solution for documents, stationery or even your tablet: this handy compartment has four quick-release fasteners for attaching to the lid of the top box, and helps keep things tidy while providing ready access to all your vital bits and pieces.

**PART NUMBER**

**Storage compartment for top box**  
Order number: 77 41 8 520 303\*



(+) = "and" – this item must be ordered at the same time  
(o) = "or" – this item may be ordered as an alternative option

**DESIGN**

1



**OPTION 719: CLASSIC FORGED WHEELS**

The glossy, milled finish is where the nine-spoke aluminium-alloy forged wheels really shine. To be fitted and/or enabled in a specialist workshop, and ideally at your BMW Motorrad dealership.

2



**PART NUMBER**

- Forged wheel, front**  
Order number: 77 21 8 388 006\*
- (+) Brake disc, front (two required)  
Order number: 34 11 8 563 499\*
  - (+) Spacer tube  
Order number: 36 31 7 676 141\*
  - (+) Shaft sealing ring (two required)  
Order number: 36 31 8 561 710\*
  - (+) Grooved ball bearing (two required)  
Order number: 36 31 8 531 207\*
  - (+) Bush bearing  
Order number: 36 31 8 551 385\*
  - (+) Cylinder screw M8x25 (12 required)  
Order number: 07 12 9 907 382\*
  - (+) Pulse wheel  
Order number: 34 52 8 523 479\*
  - (+) Cylinder screw M5x6 (six required)  
Order number: 07 12 9 907 842\*
  - (+) Angular valve  
Order number: 36 31 8 542 009\*
  - (+) Nut  
Order number: 36 31 8 542 010\*
- Forged wheel, rear**  
Order number: 77 21 8 555 597\*
- (+) Angular valve  
Order number: 36 31 8 542 009\*
  - (+) Nut  
Order number: 36 31 8 542 010\*

\* Original BMW Motorrad equipment is available from your BMW Motorrad dealer.

### CHROME PARTS

Choose the look you want: these elegant, high-quality chrome parts can be combined as you wish, giving your BMW K 1600 GTL a unique, stylish edge.

To be fitted and/or enabled in a specialist workshop, and ideally at your BMW Motorrad dealership.



#### PART NUMBER

**Chrome-plated wind deflector, left** (image 1)

Order number: 77 31 8 564 787\*

(+) Chrome-plated wind deflector, right

Order number: 77 31 8 564 788\*

**Chrome-plated mirror cap, left** (image 2)

Order number: 51 16 8 562 669\*

(+) Chrome-plated mirror cap, right

Order number: 51 16 8 562 670\*

**Chrome-plated slipstream deflector, left** (image 3)

Order number: 46 63 8 557 487\*

(+) Chrome-plated slipstream deflector, right

Order number: 46 63 8 557 488\*

(+) Expanding rivet (two required per side)

Order number: 64 22 1 356 171\*

### GROUND-LEVEL LIGHTING

Getting late? Ground-level lighting illuminates the surface below your wheels with modern LED technology, making it easier to park. If desired, the function can remain active even after the ignition key is removed.

To be fitted and/or enabled in a specialist workshop, and ideally at your BMW Motorrad dealership.

Only available in conjunction with option codes 603 and 417: anti-theft alarm system with central locking

Not approved for all countries, observe the regulations applicable to your country.

#### PART NUMBER

**Ground-level lighting**

Order number: 63 17 7 727 584\*



## ERGONOMICS & COMFORT

### LOW WINDSHIELD

Gives the BMW K 1600 GTL a sleek, track-style look while protecting the rider against wind and rain.

To be fitted and/or enabled in a specialist workshop, and ideally at your BMW Motorrad dealership.

#### PART NUMBER

**Low windshield**

Order number: 77 33 8 528 329\*



### GT WINDSHIELD

The GT windshield accentuates the dynamic contours of the BMW K 1600 GTL.

To be fitted and/or enabled in a specialist workshop, and ideally at your BMW Motorrad dealership.

#### PART NUMBER

**GT windshield**

Order number: 46 63 7 709 513\*



### ONE-PIECE SEAT

Instantly inviting, this extra-wide seat features decorative stitching and all the padding you need, offering outstanding comfort for both rider and passenger when touring. Available in three seat heights. All retrofittable seats are heated. 780 mm and 810 mm seat heights are also available.

#### PART NUMBER

**One-piece seat**

(seat height: 780 mm/step length: 1,770 mm)

Order number: 52 53 7 718 500\*

**Low one-piece seat**

(see pages 4–5)

(seat height: 750 mm/step length: 1,720 mm)

Order number: 52 53 7 729 321\*

**High one-piece seat** (not shown)

(seat height: 810 mm/step length: 1,830 mm)

Order number: 52 53 8 545 128\*



### HEIGHT-ADJUSTABLE RIDER SEAT

The seat offers a dynamic profile without compromising on comfort. Adjustable between two height positions as necessary. Two versions with different seat heights are available

**(o) High rider seat, height-adjustable** (not shown)

(seat height: 810/830 mm; step length: 1,830/1,870 mm)

Order number: 52 53 7 716 435\*

(+) Rider seat installation kit

Order number: 77 34 8 520 028\*

(+) Pillion seat

Order number: 52 53 7 712 119\*

(+) Connecting cable

Order number: 61 12 8 528 423\*

#### PART NUMBER

**Height-adjustable rider seat**

(seat height: 780/800 mm; step length: 1,775/1,810 mm)

Order number: 52 53 7 712 118\*



**PILLION PASSENGER FOOTRESTS**

These high-quality aluminium-alloy-forged footrests with rubber padding are ideal for ensuring relaxing long tours for the pillion passenger. To be fitted and/or enabled in a specialist workshop, and ideally at your BMW Motorrad dealership.

**PART NUMBER**

**Pillion footrest, left**  
Order number: 77 25 8 562 683\*  
(+) Pillion footrest, right  
Order number: 77 25 8 562 684\*



**COMFORT WINDSHIELD (NOT SHOWN)**

The comfort windshield comes with anti-scratch coating and provides maximum protection against wind and rain for both rider and pillion passenger. 20 mm higher than the standard windshield (with the same width), it also offers outstanding aeroacoustics. To be fitted and/or enabled in a specialist workshop, and ideally at your BMW Motorrad dealership.

**PART NUMBER**

**Comfort windshield**  
Order number: 77 33 7 724 350\*

**HILL START CONTROL (NOT SHOWN)**

Park or pull away on up or down gradients, even with a pillion passenger and heaps of luggage on board. Also available as an equipment option. To be fitted and/or enabled in a specialist workshop, and ideally at your BMW Motorrad dealership. For more detailed information, contact your BMW Motorrad dealership or go online at [bmw-motorrad.com](http://bmw-motorrad.com)

**PART NUMBER**

**Hill Start Control**  
Order number: 77 23 8 536 874\*

**COMFORT ARMRESTS FOR PILLION PASSENGER**

The well-padded pillion comfort armrests allow quick and easy access to the pillion seat. You can still open the top box when the armrests are folded up. To be fitted and/or enabled in a specialist workshop, and ideally at your BMW Motorrad dealership.

**PART NUMBER**

**Comfort armrests for pillion passenger**  
Order number: 77 25 8 524 692\*  
(+) Attachment for pillion comfort armrests  
Order number: 77 25 8 529 212\*

(+) Padding for pillion comfort armrests  
Order number: 77 25 8 529 864\*

(+) Cover for pillion comfort armrests, left  
– Magnesium Metallic  
Order number: 46 62 8 544 345\*  
– White Aluminium Metallic  
Order number: 77 25 8 528 937\*

(+) Cover for pillion comfort armrests, right  
– Magnesium Metallic  
Order number: 46 62 8 544 346\*  
– White Aluminium Metallic  
Order number: 77 25 8 528 938\*



**PRO GEAR-SHIFT ASSIST (NOT SHOWN)**

Delivers smooth shifts without the use of the clutch. Also available as an equipment option. To be fitted and/or enabled in a specialist workshop, and ideally at your BMW Motorrad dealership.

For more detailed information, contact your BMW Motorrad dealership or go online at [bmw-motorrad.com](http://bmw-motorrad.com)

(+) = "and" – this item must be ordered at the same time  
(o) = "or" – this item may be ordered as an alternative option

**NAVIGATION AND COMMUNICATION**



**BMW MOTORRAD NAVIGATION SYSTEMS**

Where am I? Where do I want to go, and what's the most scenic way to get there? BMW Motorrad navigation devices show you where to go. Made specifically for motorcyclists, they're easy to fit and use – even with gloves on – and come with lifetime map updates.

The new BMW Motorrad Navigator VI is your ticket to the tour of your dreams.

A whole new level of adventure awaits thanks to the "winding roads" route option, "avoid motorways" feature and the "round trip" function, which configures journeys based on time, distance or stopover. The circular polarization filter (CPOL) on the display minimizes reflection and improves contrast, ensuring the screen is easy to read, even in direct sunlight. 16 GB of flash storage, and the ability to stream music from your smartphone, are the ultimate luxury.

For more detailed information, contact your BMW Motorrad dealership or go online at [bmw-motorrad.com](http://bmw-motorrad.com)

**PART NUMBERS**

**BMW Motorrad Navigator VI**  
(with map data for Europe)  
Order number: 77 52 8 355 994\*

**BMW Motorrad Navigator VI** (without map data)  
Order number: 77 52 8 356 005\*

\* Original BMW Motorrad equipment is available from your BMW Motorrad dealer.



## SAFETY

### ENGINE PROTECTION BAR

The tough two-piece engine protection bar is made of stainless steel with a bead-blasted matt finish. It protects the engine cover against serious impacts, while blending in perfectly with the stylish profile of the BMW K 1600 GTL.

#### PART NUMBER

##### Engine protection bar, left

Order number: 77 14 8 396 741\*

(+) Engine protection bar, right

Order number: 77 14 8 396 742\*



### ANTI-THEFT ALARM SYSTEM (NOT SHOWN)

If the motorcycle is moved or struck violently, the system responds with a clearly audible signal and a flashing warning light. Also available as an equipment option with central locking. To be fitted and/or enabled in a specialist workshop, and ideally at your BMW Motorrad dealership.

#### PART NUMBER

##### Anti-theft alarm system

Order number: 77 53 8 554 348\*

### LED AUXILIARY HEADLIGHTS

The LED auxiliary headlights deliver increased safety when visibility is poor, e.g. in fog, snow and rain. Also available as an equipment option.

To be fitted and/or enabled in a specialist workshop, and ideally at your BMW Motorrad dealership.

Scheduled availability from third quarter of 2017.

The auxiliary headlights are approved for use as fog lights, and may only be used in poor weather conditions. Country-specific road traffic regulations apply.

#### PART NUMBER

##### LED auxiliary headlights (two required)

Order number: 63 17 8 532 148\*

(+) Radiator trim, left headlight

Order number: 46 63 8 569 061\*

(+) Radiator trim, right headlight

Order number: 46 63 8 569 062\*

(+) Trim, left, Monolith Matt Metallic

Order number: 46 63 8 568 915\*

(+) Trim, left, Black Storm Matt Metallic

Order number: 46 63 7 708 647\*

(+) Trim, right, Monolith Matt Metallic

Order number: 46 63 8 568 916\*

(+) Trim, right, Black Storm Matt Metallic

Order number: 46 63 7 708 648\*

(+) Plug-in nut M5 (two required)

Order number: 46 63 7 721 031\*

(+) Body panel screw M5x14 (two required)

Order number: 46 63 8 534 938\*

(+) Raised head screw M5x16 (four required)

Order number: 06 32 7 657 949\*

(+) Upper clamping block (two required)

Order number: 46 63 8 535 971\*

(+) Lower clamping block (two required)

Order number: 46 63 8 535 972\*

(+) Body panel screw M5x14 (four required)

Order number: 46 63 8 534 938\*

(+) Washer (two required)

Order number: 63 17 7 723 678\*

(+) ISA screw M8x20 (two required)

Order number: 07 12 9 904 065\*

(+) Angle bracket, left

Order number: 46 63 8 557 419\*

(+) Angle bracket, right

Order number: 46 63 8 557 420\*

(+) Body panel screw M5x14 (two required)

Order number: 46 63 8 534 938\*

(+) Additional switch for auxiliary headlights

Order number: 61 31 8 533 473\*

(+) Inner Torx screw M5x12

Order number: 07 12 9 907 413\*



(+) = "and" – this item must be ordered at the same time  
(o) = "or" – this item may be ordered as an alternative option



\* Original BMW Motorrad equipment is available from your BMW Motorrad dealer.

## EQUIPMENT FOR THE BMW K 1600 B



## STORAGE



### INNER BAGS FOR TOURING PANNIERS

These tough inner bags make it easier to load and unload the panniers or top box. They're specially fitted for the panniers, and the outer pockets with real leather sides are ideal for small items. Suitable for the left or right pannier. With shoulder strap.

#### PART NUMBERS

**Inner bag for touring panniers**  
Order number: 77 41 8 565 033\*



### IMPACT PROTECTION SYSTEM FOR TOURING PANNIERS

Made of sturdy plastic, protects the sides of panniers from scratches.

To be fitted and/or enabled in a specialist workshop, and ideally at your BMW Motorrad dealership.

#### PART NUMBER

**Impact protection system for touring pannier, left**  
Order number: 77 14 8 558 453\*  
**Impact protection system for touring pannier, right**  
Order number: 77 14 8 558 474\*

### STORAGE COMPARTMENTS (NOT SHOWN)

Practical storage compartments on the front sides of the motorcycle provide even more comfort. Also available as an equipment option.

To be fitted and/or enabled in a specialist workshop, and ideally at your BMW Motorrad dealership.

Not available in conjunction with front footrest.

For more detailed information, contact your BMW Motorrad dealership or go online at [bmw-motorrad.com](http://bmw-motorrad.com)

Model shown: BMW K 1600 GTL.

#### PART NUMBERS

**Storage compartment, left**  
Order number: 46 63 8 551 708\*  
(+) Storage compartment, right  
Order number: 46 63 8 557 436\*  
(+) Locking cylinder (two required)  
Order number: 51 25 7 698 204\*  
(+) Foot protector, left, silk gloss black  
Order number: 46 63 8 388 819\*  
(+) Foot protector, right, silk gloss black  
Order number: 46 63 8 388 818\*  
(+) Body panel screw M5x14 (five required)  
Order number: 46 63 8 534 938\*

(+) = "and" – this item must be ordered at the same time  
(o) = "or" – this item may be ordered as an alternative option

## DESIGN



### OPTION 719: CLASSIC FORGED WHEEL

The glossy, milled finish is where the nine-spoke aluminium-alloy forged wheels really shine.

To be fitted and/or enabled in a specialist workshop, and ideally at your BMW Motorrad dealership.

#### PART NUMBER

**Forged wheel, front**  
Order number: 77 21 8 388 006\*

(+) Brake disc, front (two required)  
Order number: 34 11 8 563 499\*

(+) Spacing bushing  
Order number: 36 31 8 551 385\*

(+) Shaft sealing ring (two required)  
Order number: 36 31 8 561 710\*

(+) Grooved ball bearing (two required)  
Order number: 36 31 8 531 207\*

(+) Cylinder screw M8x25 (12 required)  
Order number: 07 12 9 907 382\*

(+) Sensor ring  
Order number: 34 52 8 523 479\*

(+) ISA screw M5x6 (six required)  
Order number: 07 12 9 907 842\*

(+) Nut  
Order number: 36 31 8 542 010\*

(+) Angular valve  
Order number: 36 31 8 542 009\*

**Forged wheel, rear**  
Order number: 77 21 8 555 597\*

(+) Nut  
Order number: 36 31 8 542 010\*

(+) Angular valve  
Order number: 36 31 8 542 009\*



\* Original BMW Motorrad equipment is available from your BMW Motorrad dealer.



### CHROME PARTS

Choose the look you want: these elegant, high-quality chrome parts can be combined as you wish, giving your BMW K 1600 B a unique, stylish edge. To be fitted and/or enabled in a specialist workshop, and ideally at your BMW Motorrad dealership.

#### PART NUMBER

##### Chrome-plated wind deflector, left

Order number: 77 31 8 564 787\*

(+) Chrome-plated wind deflector, right

Order number: 77 31 8 564 788\*

##### Chrome-plated mirror cap, left

Order number: 51 16 8 562 669\*

(+) Chrome-plated mirror cap, right

Order number: 51 16 8 562 670\*

##### Chrome-plated slipstream deflector, left

(shown: BMW K 1600 GTL Elegance)

Order number: 46 63 8 557 487\*

(+) Chrome-plated slipstream deflector, right

Order number: 46 63 8 557 488\*

(+) Expanding rivet (two required per side)

Order number: 64 22 1 356 171\*

##### • Pannier trim, chrome-plated, left

Order number: 46 54 8 563 681\*

(+) Chrome-plated pannier trim, right

Order number: 46 54 8 563 682\*

(+) = "and" – this item must be ordered at the same time  
(o) = "or" – this item may be ordered as an alternative option

## ERGONOMICS & COMFORT

### LOW SEAT

30 mm lower than the standard version, this single seat makes climbing on and handling easier. Also available as an equipment option.

#### PART NUMBERS

##### Low seat

(seat height: 750 mm/step length: 1,720 mm)

Order number: 77 34 8 393 817\*



### LOW WINDSHIELD, TINTED

Tinted versions of the standard windshield lend the BMW K 1600 B a sporty look.

Scheduled availability from third quarter of 2017.

For more detailed information, contact your BMW Motorrad dealership or go online at [bmw-motorrad.com](http://bmw-motorrad.com)

#### PART NUMBER

##### (+) Low windshield, tinted

Order number: 77 33 8 395 842\*



### PILLION PASSENGER FOOTRESTS

These high-quality aluminium-alloy-forged footrests with rubber padding are ideal for ensuring relaxing long tours for the pillion passenger.

To be fitted and/or enabled in a specialist workshop, and ideally at your BMW Motorrad dealership.

#### PART NUMBER

##### Pillion footrest, left

Order number: 77 25 8 562 683\*

(+) Pillion footrest, right

Order number: 77 25 8 562 684\*



### PRO GEAR-SHIFT ASSIST (NOT SHOWN)

Delivers smooth shifts without the use of the clutch.

Also available as an equipment option.

To be fitted and/or enabled in a specialist workshop, and ideally at your BMW Motorrad dealership.

For more detailed information, contact your BMW Motorrad dealership or go online at [bmw-motorrad.com](http://bmw-motorrad.com)

#### PART NUMBER

##### Pro gear-shift assist, retrofit

Order number: 23 41 8 545 533\*

(+) Enabling code for Pro gear-shift assist

Order number: 13 61 8 545 879\*

\* Original BMW Motorrad equipment is available from your BMW Motorrad dealer.



### FOOTRESTS, FRONT

These comfortable footrests provide the driver with a more relaxed, "foot-forward" riding position. Also available as an equipment option. To be fitted and/or enabled in a specialist workshop, and ideally at your BMW Motorrad dealership. Only available in conjunction with engine protection bar. Not available in conjunction with storage compartment.

#### PART NUMBER

- Footrest, front left**  
Order number: 77 14 8 392 071\*
- (+) Footrest, front right  
Order number: 77 14 8 392 072\*
- (+) Engine protection bar set, left  
Order number: 77 14 8 396 741\*
- (+) Engine protection bar set, right  
Order number: 77 31 8 396 742\*
- (+) Mounting kit  
Order number: 77 31 8 567 876\*  
For more detailed information, contact your BMW Motorrad dealership or go online at [bmw-motorrad.com](http://bmw-motorrad.com)
- (+) Frame cover, Silk Gloss Black upper section  
Order number: 77 31 8 567 879\*
- Heat shield, left**  
Order number: 77 31 8 551 727\*
- (+) Heat shield, right  
Order number: 77 31 8 551 728\*



### GROUND-LEVEL LIGHTING

Getting late? Ground-level lighting illuminates the surface below your wheels with modern LED technology, making it easier to park. If desired, the function can remain active even after the ignition key is removed. To be fitted and/or enabled in a specialist workshop, and ideally at your BMW Motorrad dealership. Only available in conjunction with option codes 603 and 417: anti-theft alarm system with central locking. Model shown: BMW K 1600 GTL. Not approved for all countries, observe the regulations applicable to your country.

#### PART NUMBER

- Ground-level lighting**  
Order number: 63 17 7 727 584\*

### HILL START CONTROL (NOT SHOWN)

Park or pull away on up or down gradients, even with a pillion passenger and heaps of luggage on board. Also available as an equipment option. To be fitted and/or enabled in a specialist workshop, and ideally at your BMW Motorrad dealership.

#### PART NUMBER

- Hill Start Control enabling code**  
Order number: 77 23 8 536 874\*

### CENTRE STAND (NOT SHOWN)

The centre stand lets you safely park your motorcycle anywhere, while taking up less space. Also available as an equipment option. To be fitted and/or enabled in a specialist workshop, and ideally at your BMW Motorrad dealership.

#### PART NUMBER

- Centre stand**  
Order number: 46 52 8 562 360\*
- (+) Mounting kit for centre stand  
Order number: 77 25 8 394 140\*

(+) = "and" – this item must be ordered at the same time  
(o) = "or" – this item may be ordered as an alternative option

## NAVIGATION AND COMMUNICATION



### BMW MOTORRAD NAVIGATION SYSTEMS

Where am I? Where do I want to go, and what's the most scenic way to get there? BMW Motorrad navigation devices show you where to go. Made specifically for motorcyclists, they're easy to fit and use – even with gloves on – and come with lifetime map updates.

The new BMW Motorrad Navigator VI is your ticket to the tour of your dreams. A whole new level of adventure awaits thanks to the "winding roads" route option, "avoid motorways" feature and the "round trip" function, which configures journeys based on time, distance or stopover. The circular polarization filter (CPOL) on the display minimizes reflection and improves contrast, ensuring the screen is easy to read, even in direct sunlight. 16 GB of flash storage, and the ability to stream music from your smartphone, are the ultimate luxury.

For more detailed information, contact your BMW Motorrad dealership or go online at [bmw-motorrad.com](http://bmw-motorrad.com)

BMW Motorrad navigations systems only available in conjunction with "audio system navigation device preparation" (option code 267).

#### PART NUMBERS

- BMW Motorrad Navigator VI**  
(with map data for Europe)  
Order number: 77 52 8 355 994\*
- BMW Motorrad Navigator VI** (without map data)  
Order number: 77 52 8 356 005\*
- Enabling code for Bluetooth retrofit**  
Order number: 77 23 8 527 618\*  
To be fitted and/or enabled in a specialist workshop, and ideally at your BMW Motorrad dealership.  
Only available in conjunction with "audio system navigation device preparation" (option code 267).

\* Original BMW Motorrad equipment is available from your BMW Motorrad dealer.

## SAFETY



### LED AUXILIARY HEADLIGHT (NOT SHOWN)

The LED auxiliary headlights deliver increased safety when visibility is poor, e.g. in fog, snow and rain. Also available as an equipment option. To be fitted and/or enabled in a specialist workshop, and ideally at your BMW Motorrad dealership.

The auxiliary headlights are approved for use as fog lights, and may only be used in poor weather conditions. Country-specific road traffic regulations apply

#### PART NUMBER

**LED auxiliary headlights** (two required)

Order number: 63 17 8 559 207\*

(+) Radiator trim, left, primed

Order number: 46 63 8 562 481\*

(+) Radiator trim, right, primed

Order number: 46 63 8 562 482\*

(+) Trim, left, primed

Order number: 46 63 7 686 137\*

For more detailed information, contact your BMW Motorrad dealership or go online at [bmw-motorrad.com](http://bmw-motorrad.com)

(+) Trim, right, primed

Order number: 46 63 7 686 138\*

For more detailed information, contact your BMW Motorrad dealership or go online at [bmw-motorrad.com](http://bmw-motorrad.com)

(+) Plug-in nut M5 (two required)

Order number: 46 63 7 721 031\*

(+) Body panel screw M5x14 (four required)

Order number: 46 63 8 534 938\*

(+) Raised head screw M5x16 (four required)

Order number: 06 32 7 657 949\*

(+) Upper clamping block (two required)

Order number: 46 63 8 535 971\*

(+) Lower clamping block (two required)

Order number: 46 63 8 535 972\*

(+) Body panel screw M5x14 (four required)

Order number: 46 63 8 534 938\*

(+) Washer (two required)

Order number: 07 11 9 904 446\*

(+) ISA screw M8x20 (two required)

Order number: 07 12 9 904 065\*

(+) Bracket for auxiliary headlight, left

Order number: 46 63 8 557 419\*

(+) Bracket for auxiliary headlight, right

Order number: 46 63 8 557 420\*

(+) Adapter cable for LED auxiliary headlights (two required)

Order number: 61 12 8 354 800\*

(+) Additional switch for auxiliary headlights

Order number: 61 31 8 533 473\*

(+) Inner Torx screw M5x12

Order number: 07 12 9 907 413\*

(+) Cap

Order number: 61 31 8 548 924\*

(+) = "and" – this item must be ordered at the same time  
(o) = "or" – this item may be ordered as an alternative option

### ANTI-THEFT ALARM SYSTEM (NOT SHOWN)

If the motorcycle is moved or struck violently, the system responds with a clearly audible signal and a flashing warning light. Also available as an equipment option with central locking. To be fitted and/or enabled in a specialist workshop, and ideally at your BMW Motorrad dealership.

#### PART NUMBER

**Anti-theft alarm system**

Order number: 77 53 8 554 348\*

(+) Raised head screw

Order number: 07 14 9 141 517\*

### RDC (TYRE PRESSURE CONTROL) (NOT SHOWN)

Now with gradient monitoring, TPC from BMW Motorrad constantly monitors tyre pressure and provides riders with real-time updates. Riders are also alerted when there is any significant drop in pressure. Also available as an equipment option. To be fitted and/or enabled in a specialist workshop, and ideally at your BMW Motorrad dealership. For more detailed information, contact your BMW Motorrad dealership or go online at [bmw-motorrad.com](http://bmw-motorrad.com)

#### PART NUMBER

**RDC, retrofit**

Order number: 36 31 8 532 731\*

(+) RDC control unit

Order number: 65 75 8 546 222\*

(+) Sign

Order number: 71 21 7 698 971\*

(+) Bolts

Order number: 36 31 8 520 871\*

\* Original BMW Motorrad equipment is available from your BMW Motorrad dealer.



## EQUIPMENT FOR THE BMW K 1600 GA



## STORAGE



### INNER BAGS FOR TOURING PANNIERS/TOP BOX

These tough inner bags make it easier to load and unload the panniers or top box. They're specially fitted for the panniers and top box, and the outer pockets with real leather sides are ideal for small items. Inner bags for touring panniers suitable for left or right pannier. With detachable shoulder strap.



#### PART NUMBERS

**Inner bag for touring pannier** (two required)  
Order number: 77 41 8 565 033\*

**Inner bag for top box**  
Order number: 77 41 8 565 034\*



### IMPACT PROTECTION SYSTEM FOR TOURING PANNIERS

Made of sturdy plastic, protects the sides of panniers from scratches.  
To be fitted and/or enabled in a specialist workshop, and ideally at your BMW Motorrad dealership.

#### PART NUMBERS

**Impact protection system for touring pannier, left**  
Order number: 77 14 8 558 453\*

(+) **Impact protection system for touring pannier, right**  
Order number: 77 14 8 558 474\*

(+) = "and" – this item must be ordered at the same time  
(o) = "or" – this item may be ordered as an alternative option

## DESIGN



### OPTION 719: CLASSIC FORGED WHEELS

The glossy, milled finish is where the nine-spoke aluminium-alloy forged wheels really shine.  
To be fitted and/or enabled in a specialist workshop, and ideally at your BMW Motorrad dealership.



#### PART NUMBERS

**Forged wheel, front** (image 1)  
Order number: 77 21 8 388 006\*

(+) **Brake disc, front** (two required)  
Order number: 34 11 8 563 499\*

(+) **Spacing bushing**  
Order number: 36 31 8 551 385\*

(+) **Shaft sealing ring** (two required)  
Order number: 36 31 8 561 710\*

(+) **Grooved ball bearing** (two required)  
Order number: 36 31 8 531 207\*

(+) **Cylinder screw M8x25** (12 required)  
Order number: 07 12 9 907 382\*

(+) **Sensor ring**  
Order number: 34 52 8 523 479\*

(+) **ISA screw M5x6** (six required)  
Order number: 07 12 9 907 842\*

(+) **Nut**  
Order number: 36 31 8 542 010\*

(+) **Angular valve**  
Order number: 36 31 8 542 009\*

**Forged wheel, rear** (image 2)  
Order number: 77 21 8 555 597\*

(+) **Nut**  
Order number: 36 31 8 542 010\*

(+) **Angular valve**  
Order number: 36 31 8 542 009\*

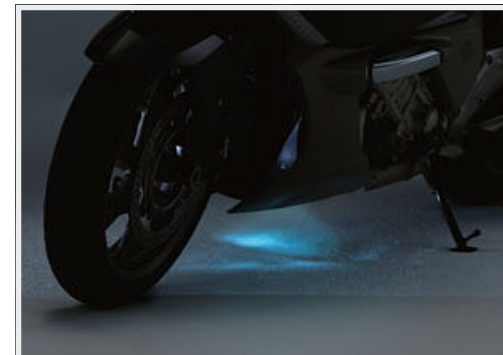

### GROUND-LEVEL LIGHTING

Getting late? Ground-level lighting illuminates the surface below your wheels with modern LED technology, making it easier to park. If desired, the function can remain active even after the ignition key is removed.

To be fitted and/or enabled in a specialist workshop, and ideally at your BMW Motorrad dealership.

Only available in conjunction with option codes 603 and 417: anti-theft alarm system with central locking

Model shown: BMW K 1600 GTL.

Not approved for all countries, observe the regulations applicable to your country.

#### PART NUMBER

**Ground-level lighting**  
Order number: 63 17 7 727 584\*

### CHROME PARTS

Choose the look you want: these elegant, high-quality chrome parts can be combined as you wish, giving your BMW K 1600 Grand America a unique, stylish edge. To be fitted and/or enabled in a specialist workshop, and ideally at your BMW Motorrad dealership.

#### PART NUMBERS

**Chrome-plated wind deflector, left** (image 1)  
Order number: 46 63 8 564 787\*

(+) Chrome-plated wind deflector, right  
Order number: 46 63 8 564 788\*

**Chrome-plated mirror cap, left** (image 2)  
Order number: 51 16 8 562 669\*

(+) Chrome-plated mirror cap, right  
Order number: 51 16 8 562 670\*

**Chrome-plated slipstream deflector, left** (image 3)  
Order number: 46 63 8 557 487\*

(+) Chrome-plated slipstream deflector, right  
Order number: 46 63 8 557 488\*

(+) Expanding rivet (two required per side)  
Order number: 64 22 1 356 171\*

**Chrome-plated pannier trim, left** (image 4)  
Order number: 46 54 8 563 681\*

(+) Chrome-plated pannier trim, right  
Order number: 46 54 8 563 682\*

**Chrome-plated top box lid trim** (not shown)  
Order number: 46 54 8 563 676\*

1



2



3



4



## ERGONOMICS & COMFORT



### ONE-PIECE SEAT

Instantly inviting, this seat features decorative stitching and all the padding you need, offering outstanding comfort for both rider and passenger alike when touring. Available in three seat heights. All retrofittable seats are heated. Seat available in a low or extra high version and as an equipment option.

#### PART NUMBERS

**Low seat**  
(seat height: 750 mm/step length: 1,720 mm)  
Order number: 77 34 8 393 817\*

**High seat**  
(seat height: 780 mm/step length: 1,770 mm)  
Order number: 77 34 8 551 586\*

**Extra high seat**  
(seat height: 810 mm/step length: 1,830 mm)  
Order number: 77 34 8 551 590\*



### PILLION PASSENGER FOOTRESTS

These high-quality aluminium-alloy-forged footrests with rubber padding are ideal for ensuring relaxing long tours for the pillion passenger. To be fitted and/or enabled in a specialist workshop, and ideally at your BMW Motorrad dealership.

#### PART NUMBERS

**Pillion footrest, left**  
Order number: 77 25 8 562 683\*

(+) Pillion footrest, right  
Order number: 77 25 8 562 684\*

### CENTRE STAND (NOT SHOWN)

The centre stand makes refuelling easier and lets you safely park your motorcycle anywhere, while taking up less space. Also available as an equipment option. To be fitted and/or enabled in a specialist workshop, and ideally at your BMW Motorrad dealership.

#### PART NUMBERS

**Centre stand**  
Order number: 46 52 8 562 360\*

(+) Mounting kit for centre stand  
Order number: 77 25 8 394 140\*

### HEAT PROTECTION FOR FRONT FOOTRESTS (NOT SHOWN)

Provides additional protection against contact with hot parts.

#### PART NUMBER

**Heat protection set** (left and right)  
Order number: 77 31 8 393 546\*



### COMFORT ARMRESTS FOR PILLION PASSENGER

The comfort armrests with extra padding fold up to allow quick and easy access to the pillion seat. You can still open the top box when the armrests are folded up.

To be fitted and/or enabled in a specialist workshop, and ideally at your BMW Motorrad dealership.

Scheduled availability from first quarter of 2018.

For more detailed information, contact your BMW Motorrad dealership or go online at [bmw-motorrad.com](http://bmw-motorrad.com)

#### PART NUMBERS

**Comfort armrests for pillion passenger, left**

Order number: 77 25 8 409 495\*

(+) Comfort armrests for pillion passenger, right

Order number: 77 25 8 409 496\*

(+) Base carrier for pillion passenger armrest

Order number: 77 14 8 557 295\*

(+) Padding for pillion comfort armrest

Order number: 77 25 8 568 473\*

(+) Cylinder head bolt M8x25 (six required)

Order number: 07 12 9 907 382\*

(+) Washer 8-200 HV-ZNNIV SI (six required)

Order number: 46 63 7 659 459\*

(+) Raised head screw M6x16 (four required)

Order number: 07 12 9 907 401\*

(+) ISA screw M6x25 (two required)

Order number: 07 12 9 907 401\*

(+) Washer 6-200 HV-ZNNIV SI (two required)

### PRO GEAR-SHIFT ASSIST (NOT SHOWN)

Delivers smooth shifts without the use of the clutch. Also available as an equipment option.

To be fitted and/or enabled in a specialist workshop, and ideally at your BMW Motorrad dealership.

For more detailed information, contact your BMW Motorrad dealership or go online at [bmw-motorrad.com](http://bmw-motorrad.com)

#### PART NUMBERS

**Pro gear-shift assist, retrofit**

Order number: 23 41 8 545 533\*

(+) Enabling code for Pro gear-shift assist

Order number: 13 61 8 545 879\*

### HILL START CONTROL (NOT SHOWN)

Park or pull away on up or down gradients, even with a pillion passenger and heaps of luggage on board.

Also available as an equipment option.

To be fitted and/or enabled in a specialist workshop, and ideally at your BMW Motorrad dealership.

#### PART NUMBER

**Hill Start Control enabling code**

Order number: 77 23 8 536 874\*

## NAVIGATION AND COMMUNICATION



### BMW MOTORRAD NAVIGATION SYSTEMS

Where am I? Where do I want to go, and what's the most scenic way to get there? BMW Motorrad navigation devices show you where to go. Made specifically for motorcyclists, they're easy to fit and use – even with gloves on – and come with lifetime map updates.

The new BMW Motorrad Navigator VI is your ticket to the tour of your dreams. A whole new level of adventure awaits thanks to the "winding roads" route option, "avoid motorways" feature and the "round trip" function, which configures journeys based on time, distance or stopover. The circular polarization filter (CPOL) on the display minimizes reflection and improves contrast, ensuring the screen is easy to read, even in direct sunlight. 16 GB of flash storage, and the ability to stream music from your smartphone, are the ultimate luxury.

For more detailed information, contact your BMW Motorrad dealership or go online at [bmw-motorrad.com](http://bmw-motorrad.com)

#### PART NUMBERS

**BMW Motorrad Navigator VI**

(with map data for Europe)

Order number: 77 52 8 355 994\*

**BMW Motorrad Navigator VI** (without map data)

Order number: 77 52 8 356 005\*



# SAFETY

## ANTI-THEFT ALARM SYSTEM (NOT SHOWN)

If the motorcycle is moved or struck violently, the system responds with a clearly audible signal and a flashing warning light. Also available as an equipment option with central locking.

To be fitted and/or enabled in a specialist workshop, and ideally at your BMW Motorrad dealership.

### PART NUMBERS

**Anti-theft alarm system**  
Order number: 77 53 8 554 348\*  
(+) Raised head screw  
Order number: 07 14 9 141 517\*

## RDC (TYRE PRESSURE CONTROL) (NOT SHOWN)

Now with gradient monitoring, TPC from BMW Motorrad constantly monitors tyre pressure and provides riders with real-time updates. Riders are also alerted when there is any significant drop in pressure. Also available as an equipment option.

To be fitted and/or enabled in a specialist workshop, and ideally at your BMW Motorrad dealership.

For more detailed information, contact your BMW Motorrad dealership or go online at [bmw-motorrad.com](http://bmw-motorrad.com)

### PART NUMBERS

**RDC retrofit** (two required)  
Order number: 36 31 8 532 731\*  
(+) RDC control unit  
Order number: 65 75 8 546 222\*  
(+) Sign (two required)  
Order number: 71 21 7 698 971\*  
(+) Repair kit for RDC valve (two required)  
Order number: 36 31 8 520 871\*

## LED AUXILIARY HEADLIGHTS

The LED auxiliary headlights deliver increased safety when visibility is poor, e.g. in fog, snow and rain. Also available as an equipment option.

To be fitted and/or enabled in a specialist workshop, and ideally at your BMW Motorrad dealership.

The auxiliary headlights are approved for use as fog lights, and may only be used in poor weather conditions. Country-specific road traffic regulations apply

### PART NUMBER

**LED auxiliary headlights** (two required)  
Order number: 63 17 8 559 207\*

(+) Radiator trim, left headlight, Black Satin Gloss  
Order number: 46 63 8 393 423\*

(+) Radiator trim, right headlight, Black Satin Gloss  
Order number: 46 63 8 393 424\*

(+) Trim, left, Black Satin Gloss  
Order number: 46 63 8 568 917\*

(+) Trim, right, Black Satin Gloss  
Order number: 46 63 8 568 918\*

(+) Plug-in nut M5 (two required)  
Order number: 46 63 7 721 031\*

(+) Body panel screw M5x14 (eight required)  
Order number: 46 63 8 534 938\*

(+) Raised head screw M5x16 (four required)  
Order number: 06 32 7 657 949\*

(+) Upper clamping block (two required)  
Order number: 46 63 8 535 971\*

(+) Lower clamping block (two required)  
Order number: 46 63 8 535 972\*

(+) Washer (two required)  
Order number: 63 17 7 723 678\*

(+) ISA screw M8x20 (two required)  
Order number: 07 12 9 904 065\*

(+) Angle bracket, left  
Order number: 46 63 8 557 419\*

(+) Angle bracket, right  
Order number: 46 63 8 557 420\*

(+) Additional switch for auxiliary headlights  
Order number: 61 31 8 533 473\*

(+) Inner Torx screw M5x12  
Order number: 07 12 9 907 413\*

(+) Adapter cable for LED auxiliary headlights (two required)  
Order number: 61 12 8 354 800\*



(+) = "and" – this item must be ordered at the same time  
(o) = "or" – this item may be ordered as an alternative option



\* Original BMW Motorrad equipment is available from your BMW Motorrad dealer.



***NEVER  
RIDE TO  
FOLLOW.***

G 310 R	132
F 800 R	138
S 1000 R	148
R 1200 R	158



***ROADSTER***

## EQUIPMENT FOR THE BMW G 310 R.



## STORAGE



### Light top box, 29L

The 29-l top box offers all the space you need for everyday trips and short tours. There's even space for a helmet.

Only available in conjunction with luggage grid.

Includes locking cylinder and luggage grid adapter plate.

Mounting instructions are available from your BMW Motorrad dealership.

For information on speed and load limitations, please refer to the instruction booklet.

#### PART NUMBERS

##### Light top box, 29l

Order number: 77 43 8 566 126\*

(+) Badge

Order number: 51 14 2 328 447\*

(+) = "and" – this item must be ordered at the same time  
(o) = "or" – this item may be ordered as an alternative option



### TOP BOX, 30l

The waterproof top box has a capacity of 30l and a maximum load of 5 kg – perfect for a helmet, for example. The lid comes with paintwork in Granite Grey Metallic and a soft-close mechanism.

Model shown: BMW R 1200 R.

Only available in conjunction with luggage grid.

For information on speed and load limitations, please refer to the instruction booklet.

#### PART NUMBERS

##### Top box, 30l

Order number: 77 43 8 543 246\*

(+) Top box lid outer shell in Granite Grey Matt Metallic

Order number: 77 43 8 553 127\*

(+) Badge

Order number: 31 42 7 708 518\*

(+) Raised head screw (six required)

Order number: 07 14 7 698 893\*

(+) Locking cylinder for top box with 2 keys

Order number: 51 25 7 688 957\*

(o) Repair kit for locking cylinder

Order number: 51 25 7 698 204\*

### TANK BAG, 13–20L

The capacity of the main compartment can be expanded from 13 to 20l.

Extra space is available in the map pocket and two exterior pockets. A waterproof rain cover keeps everything dry, while sophisticated and highly practical fasteners hold everything securely in place.

#### PART NUMBER

##### Tank bag, 13–20l

Order number: 77 45 2 450 396\*



\* Original BMW Motorrad equipment is available from your BMW Motorrad dealer.



### INNER BAG FOR LIGHT TOP BOX (29l) AND TOP BOX (30l)

Makes loading and unloading a top box even easier. The inner bag comes with a practical carry handle and can be folded flat when not in use.

#### PART NUMBER

##### Inner bag for top box

Order number: 77 43 8 549 130\*

### LUGGAGE GRID

The sturdy cast-aluminium luggage grid in Silver is ideal for securing the top box or other large items.

For more detailed information, contact your BMW Motorrad dealership or go online at [bmw-motorrad.com](http://bmw-motorrad.com)

To be fitted and/or enabled in a specialist workshop, and ideally at your BMW Motorrad dealership.





## ERGONOMICS & COMFORT

### HEATED GRIPS (NOT SHOWN)

Warm hands feel good, which is why these heated handlebar grips have two settings designed to keep hands and fingers pleasantly warm. For more detailed information, contact your BMW Motorrad dealership or go online at [bmw-motorrad.com](http://bmw-motorrad.com). To be fitted and/or enabled in a specialist workshop, and ideally at your BMW Motorrad dealership.

1



2



### SEATS

The high padded seat provides a more comfortable raised seating position for taller riders. The low seat (15 mm lower) makes handling and climbing on easier.

#### PART NUMBERS

**Low seat** (image 1)  
(seat height: 770 mm; step length: 1,730 mm)  
Order number: 52 53 8 562 135\*

**High seat** (image 2)  
(seat height: 800 mm; step length: 1,790 mm)  
Order number: 77 34 8 562 491\*

## NAVIGATION



### BMW MOTORRAD SMARTPHONE CRADLE

Now you can charge your phone out on the road with BMW Motorrad's waterproof smartphone cradle. Charging takes place wirelessly or via a plug-in connection. The display and navigation functions are perfectly positioned in your field of vision and can be easily operated from the cradle. For smartphones with 5" displays or smaller. Max. dimensions: 13.8 cm x 7.3 cm x 1.1 cm. Only in combination with bracket for BMW Motorrad navigation devices.

#### PART NUMBER

**BMW Motorrad smartphone cradle**  
Order number: 77 52 8 563 125\*



### BMW MOTORRAD NAVIGATION SYSTEMS

Where am I? Where do I want to go, and what's the most scenic way to get there? BMW Motorrad navigation devices show you where to go. Made specifically for motorcyclists, they're easy to use – even with gloves on – and come with lifetime map updates.

The new BMW Motorrad Navigator VI is your ticket to the tour of your dreams. A whole new level of adventure awaits thanks to the "winding roads" route option, "avoid motorways" feature and the "round trip" function, which configures journeys based on time, distance or stopover. The circular polarization filter (CPOL) on the display minimizes reflection and improves contrast, ensuring the screen is easy to read, even in direct sunlight. 16 GB of flash storage, and the ability to stream music from your smartphone, are the ultimate luxury.

BMW Motorrad navigation devices and the BMW Motorrad smartphone cradle can only be mounted using the BMW Motorrad navigation device bracket.

For more detailed information, contact your BMW Motorrad dealership or go online at [bmw-motorrad.com](http://bmw-motorrad.com)

#### PART NUMBERS

**BMW Motorrad Navigator VI with cradle mount** (top image)

Order number: 77 52 8 355 749\*

**BMW Motorrad Navigator VI** (without map data)

Order number: 77 52 8 356 005\*

(+) 4-button cradle mount

Order number: 77 52 8 544 464\*

**BMW Motorrad Navigator Street** (bottom image)

Order number: 77 52 8 557 855\*

**Bracket for BMW Motorrad navigation devices**

Order number: 77 52 8 552 094\*

Not available for the BMW R nineT Racer.

Mounting instructions are available from your BMW Motorrad dealership.

(+) Screw M8x30 (two required)

Order number: 77 52 7 724 321\*

**Bracket for BMW Motorrad navigation devices**

Order number: 77 52 8 563 044\*

Not available for the BMW R nineT, Pure, Scrambler or Urban G/S.

**Car mounting kit for Navigator VI**

Order number: 77 52 8 544 460\*

**Bracket for BMW Motorrad navigation devices**

Order number: 77 52 8 552 094\*

Not available for the BMW R nineT Racer.

Mounting instructions are available from your BMW Motorrad dealership.

(+) Screw M8x30 (two required)

Order number: 77 52 7 724 321\*

**Bracket for BMW Motorrad navigation devices**

Order number: 77 52 8 563 044\*

Not available for the BMW R nineT, Pure, Scrambler or Urban G/S.

**Car mounting kit for Navigator VI**

Order number: 77 52 8 544 460\*

# SAFETY



## LED INDICATORS

Cutting-edge design inside and out. The LED indicators complement the design of the BMW G 310 R perfectly – and thanks to reduced energy consumption and significantly longer bulb life, they're also a shining example of efficiency.

To be fitted and/or enabled in a specialist workshop, and ideally at your BMW Motorrad dealership.

### PART NUMBER

**LED indicators** (four required)  
Order number: 63 13 8 522 499\*



(+) = "and" – this item must be ordered at the same time  
(o) = "or" – this item may be ordered as an alternative option



\* Original BMW Motorrad equipment is available from your BMW Motorrad dealer.

## EQUIPMENT FOR THE BMW F 800 R.



## HP PARTS

### HP MILLED FOOT PEGS

Grey CNC-milled anodized foot pegs made from high-strength aluminium alloy give the BMW F 800 R a track-style look. The ribbed footboard provides a secure base for the rider's feet, ensuring better control over the bike. To be fitted and/or enabled in a specialist workshop, and ideally at your BMW Motorrad dealership.

#### PART NUMBERS

**HP milled foot peg, left**  
Order number: 77 25 8 551 861\*  
(+) HP milled foot peg, right  
Order number: 77 25 8 551 862\*



### HP MILLED BRAKE AND CLUTCH LEVERS

The CNC-milled HP hand levers made from corrosion-resistant, anodized aluminium are adjustable between four positions via a screw mechanism. To be fitted and/or enabled in a specialist workshop, and ideally at your BMW Motorrad dealership.

#### PART NUMBERS

**HP milled clutch lever**  
Order number: 77 22 8 551 860\*  
(+) HP milled brake lever  
Order number: 71 60 7 706 739\*



### HP SPORT SILENCER (NOT SHOWN)

Made entirely out of titanium and stainless steel and to an exceptional level of craftsmanship, this slip-on silencer delivers a powerful rumble. It's also remarkably lightweight. To be fitted and/or enabled in a specialist workshop, and ideally at your BMW Motorrad dealership. Mounting instructions are available from your BMW Motorrad dealership.

#### PART NUMBER

**HP sport silencer**  
Order number: 77 11 8 567 783\*

(+) = "and" – this item must be ordered at the same time  
(o) = "or" – this item may be ordered as an alternative option

## STORAGE

### SMALL TOP BOX (28 l) WITH BACKREST PAD

The waterproof top box holds one helmet with space to spare. It's quick and easy to mount onto the luggage grid. And with the optional backrest pad, it provides increased comfort for the pillion passenger.

#### PART NUMBERS

**Small waterproof top box, 28 l**  
Order number: 77 43 7 724 352\*  
To be fitted and/or enabled in a specialist workshop, and ideally at your BMW Motorrad dealership.  
(+) Locking cylinder with key  
Order number: 51 25 7 688 957\*  
(+) Locking cylinder (with codes) for central locking with motorcycle  
Order number: 51 25 7 681 200\*  
**Backrest pad for small top box**  
Order number: 71 60 7 693 672\*



### TOURING PANNIERS

Sturdy, splash-proof touring panniers with a total capacity of 55 l (27 l left, 28 l right) per 10 kg load. The right pannier has space for one helmet. Smart design for easy loading and unloading.

#### PART NUMBERS

**Touring pannier, left**  
Order number: 77 41 8 529 893\*  
**Touring pannier, right**  
Order number: 77 41 8 529 894\*  
(+) Mounting kit (two required)  
Order number: 71 60 7 680 840\*  
(+) Locking cylinder (with codes) for central locking with motorcycle (two required)  
Order number: 51 25 7 681 200\*  
(o) Repair kit for locking cylinder  
Order number: 51 25 7 698 204\*



### INNER BAG FOR SMALL TOP BOX, 28 l

Makes loading and unloading a top box even easier. Also comes with a practical carry handle.

#### PART NUMBER

**Inner bag for small top box**  
Order number: 71 60 7 680 541\*

\* Original BMW Motorrad equipment is available from your BMW Motorrad dealer.



**INNER BAGS FOR TOURING PANNIERS**

These practical, water-resistant inner bags make full use of the capacity of the touring panniers. Luggage can be accessed easily with one hand, and the bag can even be worn over the shoulder thanks to a detachable strap.

**PART NUMBER**

- Inner bag for touring pannier, left**  
Order number: 77 49 8 534 714\*
- Inner bag for touring pannier, right**  
Order number: 77 49 8 534 715\*



**WATERPROOF TANKBAG**

Sturdy tankbag with a waterproof 12l inner compartment.

**PART NUMBERS**

- Waterproof tankbag**  
Order number: 71 60 7 691 391\*
- (+) Tankbag attachment  
Order number: 71 60 7 699 045\*



**LUGGAGE GRID**

If you need to take that little bit extra, you can still fit an additional softbag or the waterproof top box onto the luggage grid to ensure you have everything you need for that grand tour. The luggage grid is needed in order to fit panniers.

**PART NUMBER**

- Luggage grid**  
Order number: 71 60 7 693 917\*



**PANNIER RACKS**

These sturdy pannier racks blend in perfectly with the vehicle's overall concept, providing a firm, secure hold for the touring panniers quickly and easily. Only available in conjunction with luggage grid.

**PART NUMBER**

- Pannier racks**  
Order number: 71 60 7 719 744\*



**TANKBAG**

The tankbag sits snugly on the tank without obstructing the rider's view of the BMW Motorrad Navigator. The waterproof main compartment is expandable from 10 to 14l. The tankbag also includes a highly water-resistant map pocket.

**PART NUMBER**

- Tankbag**  
Order number: 77 45 8 534 702\*



**UNIVERSAL TANKBAG**

The waterproof main compartment can be expanded from 10 to 12l, and the highly water-resistant map pocket can also accommodate other items (a mobile phone, for example). The water-resistant exterior pocket can accommodate two 0.5-l PET bottles.

**PART NUMBERS**

- Universal tankbag**  
Order number: 77 49 7 726 994\*
- (+) Attachment for small tankbag  
Order number: 77 49 8 520 292\*

**SPORT PANNIERS**

The capacity of the sport panniers can be adjusted (15–25l per pannier). The waterproof inside pockets are built into the system. The complete pannier set (pannier rack and luggage grid) can be quickly secured to and removed from the rack system.

**PART NUMBERS**

- Sport pannier, left**  
Order number: 71 60 7 719 740\*
- Sport pannier, right**  
Order number: 71 60 7 722 364\*
- (+) Mounting kit (two required)  
Order number: 71 60 7 680 840\*
- (+) Locking cylinder (with codes) for central locking with motorcycle (two required)  
Order number: 51 25 7 681 200\*
- (o) Repair kit for locking cylinder  
Order number: 51 25 7 698 204\*



(+) = "and" – this item must be ordered at the same time  
(o) = "or" – this item may be ordered as an alternative option

\* Original BMW Motorrad equipment is available from your BMW Motorrad dealer.

## DESIGN



### LED INDICATORS

Cutting-edge design inside and out. The LED indicators complement the design of the BMW F 800 R perfectly – and thanks to reduced energy consumption and significantly longer bulb life, they're also a shining example of efficiency.

To be fitted and/or enabled in a specialist workshop, and ideally at your BMW Motorrad dealership.

#### PART NUMBERS

**LED indicators, front** (two required)  
Order number: 63 13 8 522 499\*

**LED indicators, rear** (two required)  
Order number: 63 23 8 522 500\*



### LED REAR LIGHT

Bright and energy-efficient. To be fitted and/or enabled in a specialist workshop, and ideally at your BMW Motorrad dealership.

#### PART NUMBERS

**LED rear light**  
Order number: 63 21 7 714 557\*

(o) LED rear light (USA)  
Order number: 63 21 7 714 558\*

(+) Adapter kit for LED rear light  
Order number: 71 60 7 723 027\*

(+) Cable harness for LED rear light  
Order number: 61 11 8 532 308\*

(o) Cable harness for LED rear light (USA)  
Order number: 61 11 8 532 309\*



### PLASTIC ENGINE SPOILER

The elegant engine spoiler underlines the refined, dynamic look of the BMW F 800 R. It is not possible to combine the plastic engine spoiler and engine protection bar.

#### PART NUMBER

**Plastic engine spoiler**  
Order number: 71 60 7 699 463\*



### PRIMED SEAT COVER

The seat cover is fitted over the pillion seat, giving the BMW F 800 R a dynamic single-seater look. Can be painted in any bike colour (image: Light White).

#### PART NUMBER

**Primed seat cover**  
Order number: 71 60 7 702 129\*

## ERGONOMICS & COMFORT

### SEATS

Low seat variants make it easy to climb on and ensure riders find the optimal knee angle for maximum control. In the 770 mm variant.

#### PART NUMBERS

**Low seat, Black**  
(seat height: 780 mm; step length: 1,770 mm)  
Order number: 52 53 8 554 097\*

**Extra low seat, Black**  
(seat height: 770 mm; step length: 1,740 mm)  
Order number: 52 53 8 554 099\*



### COMFORT SEATS

Wider and with extra padding, this seat (height: 820 mm) provides greater comfort on long tours. The high comfort seat (height: 840 mm) ensures the optimum knee angle for taller riders.

#### PART NUMBERS

**Comfort seat**  
(seat height: 820 mm; step length: 1,835 mm)  
Order number: 52 53 8 528 623\*

**High comfort seat** (not shown)  
(seat height: 840 mm; step length: 1,875 mm)  
Order number: 77 34 8 544 479\*

### SEAT, BLACK (NOT SHOWN)

#### PART NUMBER

**Seat, Black**  
(seat height: 790 mm; step length: 1,780 mm)  
Order number: 52 53 8 549 484\*





### HIGH WINDSHIELD

The windshield is 13 cm higher and 7 cm wider, providing even better protection against wind and weather. It's also slightly tinted and has a scratch-resistant coating that ensures unimpeded visibility.

#### PART NUMBER

**High windshield**  
Order number: 77 33 8 545 827\*



### CENTRE STAND

The sturdy centre stand ensures that the bike remains stable even on loose surfaces.

#### PART NUMBERS

**Centre stand**  
Order number: 71 60 7 719 820\*  
(+) Centre stand attachment  
Order number: 71 60 7 720 932\*



### HEATED GRIPS AND SWITCHES

Warm hands feel good, which is why these heated handlebar grips have two settings designed to keep hands and fingers pleasantly warm.

For more detailed information, contact your BMW Motorrad dealership or go online at [bmw-motorrad.com](http://bmw-motorrad.com)

To be fitted and/or enabled in a specialist workshop, and ideally at your BMW Motorrad dealership.

## NAVIGATION AND COMMUNICATION



### BMW MOTORRAD NAVIGATION SYSTEMS

Where am I? Where do I want to go, and what's the most scenic way to get there?

BMW Motorrad navigation devices show you where to go. Made specifically for motorcyclists, they're easy to fit and use – even with gloves on – and come with lifetime map updates.

The new BMW Motorrad Navigator VI is your ticket to the tour of your dreams. A whole new level of adventure awaits thanks to the “winding roads” route option, “avoid motorways” feature and the “round trip” function, which configures journeys based on time, distance or stopover. The circular polarization filter (CPOL) on the display minimizes reflection and improves contrast, ensuring the screen is easy to read, even in direct sunlight. 16 GB of flash storage, and the ability to stream music from your smartphone, are the ultimate luxury.

BMW Motorrad navigation devices and the BMW Motorrad smartphone cradle can only be mounted using the BMW Motorrad navigation device bracket.

For more detailed information, contact your BMW Motorrad dealership or go online at [bmw-motorrad.com](http://bmw-motorrad.com)

#### PART NUMBERS

**BMW Motorrad Navigator VI with cradle mount** (top image)

Order number: 77 52 8 355 749\*

**BMW Motorrad Navigator VI** (without map data)

Order number: 77 52 8 356 005\*

(+) 4-button cradle mount

Order number: 77 52 8 544 464\*

**BMW Motorrad Navigator Street** (bottom image)

Order number: 77 52 8 557 855\*

**Bracket for BMW Motorrad navigation devices**

Order number: 77 52 8 529 421\*

(+) Mounting screw (four required)

Order number: 32 71 7 652 161\*

**Car mounting kit for Navigator VI**

Order number: 77 52 8 544 460\*



### BMW MOTORRAD SMARTPHONE CRADLE

Now you can charge your phone out on the road with BMW Motorrad's waterproof smartphone cradle. Charging takes place wirelessly or via a plug-in connection. The display and navigation functions are perfectly positioned in your field of vision and can be easily operated from the cradle. For smartphones with 5" displays or smaller. Max. dimensions: 13.8 cm x 7.3 cm x 1.1 cm.

Only in combination with bracket for BMW Motorrad navigation devices.

#### PART NUMBER

**BMW Motorrad smartphone cradle**

Order number: 77 52 8 563 125\*

# SAFETY

## ANTI-THEFT ALARM SYSTEM WITH REMOTE CONTROL

If the motorcycle is moved or struck violently, the system responds with a clearly audible signal and a flashing warning light. Easy to operate remotely. To be fitted and/or enabled in a specialist workshop, and ideally at your BMW Motorrad dealership. Mounting instructions are available from your BMW Motorrad dealership.



### PART NUMBERS

#### Anti-theft alarm system with remote control

Order number: 77 53 8 545 003\*

(+) Bracket for anti-theft alarm system

Order number: 65 75 7 718 385\*



## ASC (AUTOMATIC STABILITY CONTROL), SWITCHABLE

Controls and optimizes transmission and prevents rear wheel spin – on wet surfaces, for example. For more detailed information, contact your BMW Motorrad dealership or go online at [bmw-motorrad.com](http://bmw-motorrad.com). To be fitted and/or enabled in a specialist workshop, and ideally at your BMW Motorrad dealership.

## ENGINE PROTECTION BAR

If the worst comes to the worst, the optional engine protection bar provides extra protection against damage. It is not possible to combine the plastic engine spoiler and engine protection bar.



### PART NUMBER

#### Engine protection bar

Order number: 71 60 7 695 395\*

(+) = "and" – this item must be ordered at the same time  
(o) = "or" – this item may be ordered as an alternative option



\* Original BMW Motorrad equipment is available from your BMW Motorrad dealer.

## EQUIPMENT FOR THE BMW S 1000 R.



## HP PARTS

### HP RIDER FOOT PEGS AND HP PILLION PASSENGER FOOT PEGS

These CNC-milled HP foot pegs combine aesthetic appeal with exceptional functionality. A wide range of adjustment options offer riders everything they need when it comes to ergonomics and track-style riding. To be fitted and/or enabled in a specialist workshop, and ideally at your BMW Motorrad dealership.

#### PART NUMBERS

##### HP rider foot pegs, left

Order number: 77 25 8 550 773\*

(+) HP rider foot peg, right (image 1)

Order number: 77 25 8 569 048\*

(+) Brake line control circuit

Order number: 34 32 8 549 515\*

HP pillion passenger foot pegs (not shown)

Order number: 77 25 8 358 688\*

HP passenger footrest, black (image 2)

Order number: 77 25 2 452 955\*

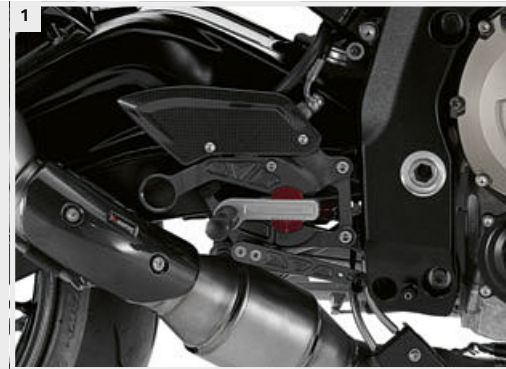

(+) = "and" – this item must be ordered at the same time  
(o) = "or" – this item may be ordered as an alternative option

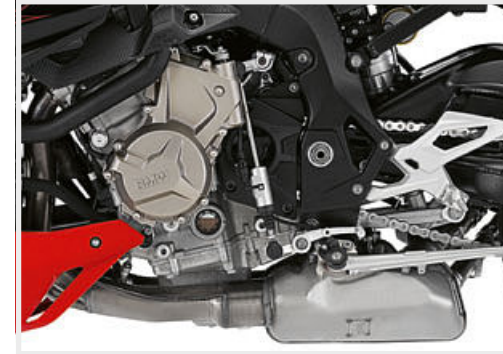

### PRO GEAR-SHIFT ASSIST

Delivers smooth acceleration without using the clutch lever – 10 times faster than normal gear shifts. To be fitted and/or enabled in a specialist workshop, and ideally at your BMW Motorrad dealership.

#### PART NUMBERS

##### Pro gear-shift assist

Order number: 23 41 8 549 125\*

(+) Enabling code for Pro gear-shift assist

Order number: 13 61 8 545 879\*

(+) Micro switch

Order number: 61 31 8 529 368\*

(+) Lever with intermediate plate

Order number: 32 72 8 556 669\*

### HP FORGED WHEELS

The forged, Black-anodized HP aluminium wheels deliver improved responses and a significant weight reduction (2 kg compared to standard wheels). Mounting instructions are available from your BMW Motorrad dealership.

#### PART NUMBERS

##### HP forged wheel, front (image 1)

Order number: 36 31 8 548 892\*

(+) Sensor ring T=48

Order number: 34 52 8 523 479\*

(+) Brake disc (two required)

Order number: 34 11 8 523 478\*

(+) Cylinder screw M8x25 (12 required)

Order number: 07 12 9 907 382\*

(+) ISA screw M5x6 (six required)

Order number: 07 12 9 907 842\*

##### HP forged wheel, rear (image 2)

Order number: 36 31 8 548 893\*

(+) Spacing bushing

Order number: 33 81 8 523 331\*

(+) Spacing bushing

Order number: 36 31 8 534 822\*

(+) Camshaft sprocket carrier

Order number: 33 81 8 530 679\*

(+) Damper (five required)

Order number: 33 81 8 530 682\*

(+) Camshaft sprocket T=45

Order number: 33 81 8 532 146\*

(+) Fitting screw M12x1.5 (five required)

Order number: 33 81 8 532 733\*

(+) Flange nut (five required)

Order number: 27 71 7 724 142\*



### HP ENGINE PROTECTORS

Aluminium engine protectors with plastic sliders provide additional protection for your engine. To be fitted and/or enabled in a specialist workshop, and ideally at your BMW Motorrad dealership.

#### PART NUMBERS

##### HP engine protector, left (image 1)

Order number: 77 25 8 545 293\*

(+) HP engine protector, right (image 2)

Order number: 77 25 8 545 292\*

\* Original BMW Motorrad equipment is available from your BMW Motorrad dealer.



### HP CLUTCH LEVER PROTECTOR / HP CLUTCH LEVER PROTECTOR

These lever guards are essential on the racetrack and show the bike's racing pedigree on public roads.

#### PART NUMBERS

**HP clutch lever protector** (not shown)  
Order number: 77 22 8 555 583\*  
Only available in conjunction with folding HP clutch lever.

**HP brake lever protector**  
Order number: 77 22 8 555 582\*  
Model shown: BMW S 1000 RR.



### FOLDING HP BRAKE AND CLUTCH LEVERS

Made out of corrosion-resistant, anodized aluminium, the CNC-milled HP brake and clutch levers are both stylish and highly practical. Easily adjustable to provide the most suitable position for every rider, the built-in folding design also reduces the risk of bending or breaking in the event of an accident. To be fitted and/or enabled in a specialist workshop, and ideally at your BMW Motorrad dealership.



### HP AXLE PROTECTORS

These highly abrasion-resistant plastic crash pads for the front and rear axles protect the fork and swing arm from damage.

Mounting instructions are available from your BMW Motorrad dealership.

#### PART NUMBER

**HP axle protectors** (two required)  
Order number: 77 25 8 356 929\*

#### PART NUMBERS

**Folding HP clutch lever** (image 1)  
Order number: 77 22 8 537 509\*

**Folding HP brake lever** (image 2)  
Order number: 77 22 8 537 510\*

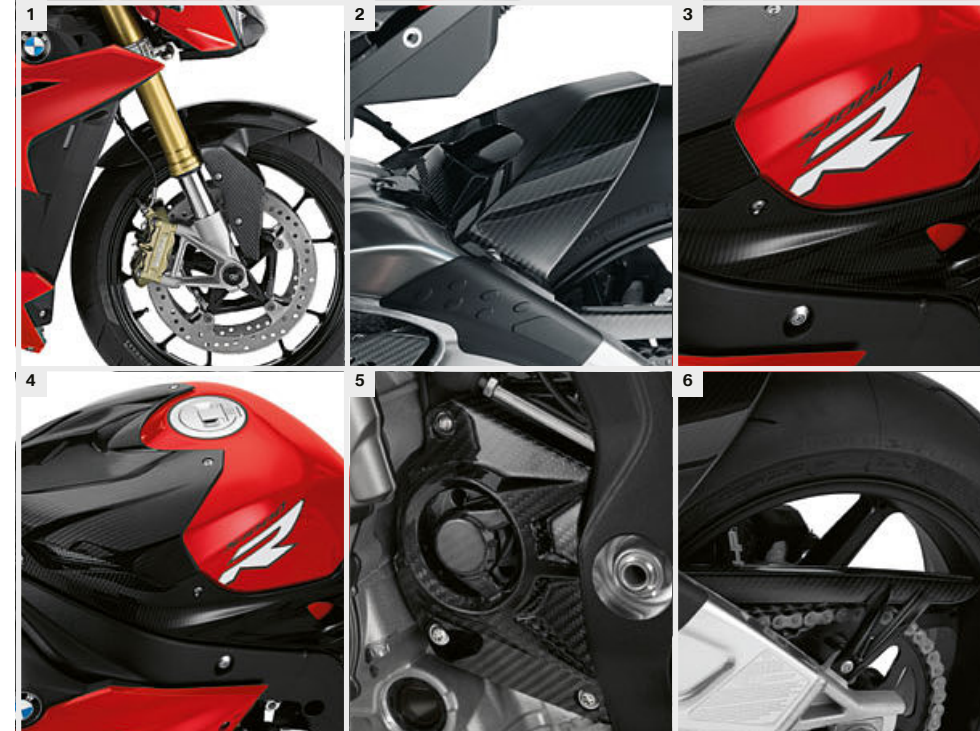

### HIGH PERFORMANCE CARBON BOLT-ON PARTS

Superlative performance is a given with these bolt-on parts. They're elegant, exclusive and durable – each one a masterpiece in its own right. And if perfection's what you're after, you've hit the jackpot here because they're made of carbon, the ultimate lightweight material. An unbeatable combination of stylish looks and technical expertise.

Mounting instructions are available from your BMW Motorrad dealership.

#### PART NUMBERS

**HP carbon mudguard, front** (image 1)  
Order number: 77 31 8 549 539\*

(+) Body panel screw M5x14 (four required)  
Order number: 46 63 8 534 938\*

(+) Plastic washer (four required)  
Order number: 46 63 7 714 241\*

**HP carbon mudguard, rear** (image 2)  
Order number: 77 31 8 546 482\*

(+) Attachment for HP carbon mudguard, rear  
Order number: 77 31 7 727 954\*

**HP carbon tank cover, left** (image 3)  
Order number: 77 31 8 550 751\*

(+) HP carbon tank cover, right  
Order number: 77 31 8 550 750\*

(+) Body panel screw M5x14 (two required)  
Order number: 46 63 8 534 938\*

(+) Body panel screw M5x20 (four required)  
Order number: 46 63 8 527 780\*

(+) Plastic washer (six required)  
Order number: 46 63 7 714 241\*

**HP carbon airbox cover** (image 4)  
Order number: 77 31 8 537 855\*

(+) Body panel screw M5x14 (six required)  
Order number: 46 63 8 534 938\*

(+) Body panel screw M5x35 (one required)  
Order number: 46 63 8 534 940\*

(+) Plastic washer (three required)  
Order number: 46 63 7 714 241\*

**HP carbon sprocket cover**  
(model shown: BMW S 1000 XR) (image 5)  
Order number: 77 31 8 555 880\*

**HP carbon chain guard** (image 6)  
Order number: 71 60 7 714 596\*

(+) Raised head screw M5x14 MK (two required)  
Order number: 46 61 7 713 314\*

**HP carbon wind deflector** (not shown)  
Order number: 77 31 8 559 259\*



### USEFUL GEAR FOR THE RACETRACK

Only for track use (not homologated for road use).

#### PART NUMBERS

**HP infrared receiver for lap timer** (image 1)

Order number: 71 60 7 715 830\*  
Mounting instructions are available from your BMW Motorrad dealership.

(+) HP infrared transmitter for lap timer  
Order number: 71 60 7 715 836\*

**HP cover kit** (image 2)  
Order number: 77 31 8 520 178\*

Of the parts illustrated, only the license plate holder cover can be used on the BMW S 1000 R.

(+) Raised head screw for mirror covers (four required)  
Order number: 46 62 7 652 556\*

(+) Raised head screw M5x30 (three required)  
Order number: 46 54 7 699 778\*

(+) Grommet (three required)  
Order number: 62 21 7 670 749\*

(+) Blind cap set for cable harness  
Order number: 77 53 8 526 536\*

(+) BMW badge  
Order number: 31 42 7 708 518\*



**USEFUL GEAR  
(ON AND OFF THE TRACK)**

**PART NUMBERS**

- HP seat** (image 1)  
Order number: 77 34 8 546 602\*
- (+) **Mounting kit**  
Order number: 77 34 8 550 363\*
- HP tyre warmer** (image 2)  
Order number: 77 02 8 543 059\*
- Motorcycle carpet** (image 3)  
Order number: 77 02 2 414 857\*
- HP chain tensioner** (image 4)  
Order number: 77 25 8 560 292\*



(+) = "and" – this item must be ordered at the same time  
(o) = "or" – this item may be ordered as an alternative option

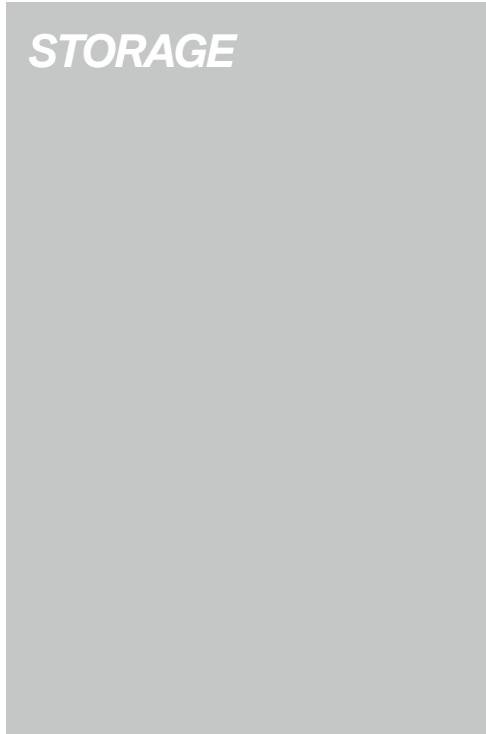

**STORAGE**

**REAR BAG**

The tough, waterproof rear bag is made of easy-care fabric, and the capacity is expandable from 25 to 32l. The bag is a perfect match for the design of the BMW S 1000 R, and can even be used when riding at high speeds.  
For solo riding only.  
Cannot be fitted at the same time as the plastic seat hump cover.



**PART NUMBER**

**Rear bag**  
Order number: 77 49 8 545 894\*



**TANKBAG**

The tankbag fits snugly onto the tank. The lockable main compartment is waterproof and has a capacity of 13l. The tankbag has a highly water-resistant map pocket. There's also a small, water-resistant exterior pocket for easy access to small items.

**PART NUMBER**

**Tankbag**  
Order number: 77 45 8 545 898\*



**SADDLE BAGS**

Fabric saddle bags with removable waterproof inner bags and 10l capacity (expandable up to 16l) per side. Quick-lock design for easy on-and-off before the next tour or race.

**PART NUMBER**

**Saddle bags**  
Order number: 77 40 2 446 914\*



**BAG FOR PILLION SEAT**

Compact, sturdy and waterproof, this bag fixes snugly onto the pillion seat and has a 2.5l capacity (expandable up to 5.5l).  
For solo riding only.  
Cannot be fitted at the same time as the plastic seat hump cover.

**PART NUMBER**

**Bag for pillion seat**  
Order number: 77 49 8 562 631\*

\* Original BMW Motorrad equipment is available from your BMW Motorrad dealer.

## DESIGN



### PLASTIC ENGINE SPOILER IN BIKE COLOUR

Emphasizes the striking design of the BMW S 1000 R and gives it an even sportier look. To be fitted and/or enabled in a specialist workshop, and ideally at your BMW Motorrad dealership.

#### PART NUMBERS

**Engine spoiler, left, Light White**

Order number: 46 63 8 549 523\*

**Engine spoiler, left, Racing Red**

Order number: 46 63 8 549 525\*

**Engine spoiler, left, Black Storm Metallic**

Order number: 46 63 8 542 627\*

(+) Engine spoiler, right, Light White

Order number: 46 63 8 549 524\*

**Engine spoiler, right, Racing Red**

Order number: 46 63 8 549 526\*

**Engine spoiler, right, Black Storm Metallic**

Order number: 46 63 8 542 628\*

(+) Engine spoiler attachment

Order number: 77 31 8 550 977\*

## ERGONOMICS & COMFORT



### COMFORT SEAT

Wider than the standard version, the striking padded comfort seat is perfect for longer tours.

#### PART NUMBER

**Comfort seat**

(seat height: 840 mm; step length: 1,865 mm)

Order number: 77 34 8 544 942\*



### PILLION COMFORT SEAT

The pillion comfort seat is padded and wider than the standard version, and significantly increases passenger comfort.

#### PART NUMBERS

**Pillion comfort seat**

Order number: 77 34 8 549 541\*

(+) Locking cylinder (with codes) for central locking with motorcycle

Order number: 51 25 7 681 200\*

The locking cylinder for the pillion seat can also be used.



### LED INDICATORS

Cutting-edge design inside and out. The LED indicators complement the design of the BMW S 1000 R perfectly – and thanks to reduced energy consumption and significantly longer bulb life, they're also a shining example of efficiency.

To be fitted and/or enabled in a specialist workshop, and ideally at your BMW Motorrad dealership.

#### PART NUMBERS

**LED indicators** (four required)

Order number: 63 13 8 522 503\*

(+) Installation kit for LED indicators

Order number: 77 51 8 551 391\*



### PLASTIC SEAT HUMP COVER

Mounted in place of pillion seat. Gives the BMW S 1000 R an even more dynamic look.

For solo riding only.

Not available in conjunction with the rear bag or pillion seat bag.

#### PART NUMBERS

Plastic seat hump cover

– **Black Storm Metallic**

Order number: 77 31 8 556 218\*

(+) Attachment for seat hump cover

Order number: 77 31 8 520 252\*

(+) Locking cylinder (with codes) for central locking with motorcycle

Order number: 51 25 7 681 200\*

The locking cylinder for the pillion seat can also be used.

(o) Repair kit for locking cylinder for central locking with motorcycle and/or panniers

Order number: 51 25 7 698 204\*



### SPORT WINDSHIELD, TINTED

The sport windshield comes with a scratch-resistant coating and provides perfect protection against wind and rain.

To be fitted and/or enabled in a specialist workshop, and ideally at your BMW Motorrad dealership.

#### PART NUMBER

**Sport windshield, tinted**

Order number: 46 63 8 546 224\*

### HEATED GRIPS AND SWITCHES (NOT SHOWN)

Warm hands feel good, which is why these heated handlebar grips have two settings designed to keep hands and fingers pleasantly warm.

For more detailed information, contact your BMW Motorrad dealership or go online at [bmw-motorrad.com](http://bmw-motorrad.com)

To be fitted and/or enabled in a specialist workshop, and ideally at your BMW Motorrad dealership.

Not shown.

## NAVIGATION



### BMW MOTORRAD NAVIGATION SYSTEMS

Where am I? Where do I want to go, and what's the most scenic way to get there?

BMW Motorrad navigation devices show you where to go. Made specifically for motorcyclists, they're easy to fit and use – even with gloves on – and come with lifetime map updates.

The new BMW Motorrad Navigator VI is your ticket to the tour of your dreams. A whole new level of adventure awaits thanks to the “winding roads” route option, “avoid motorways” feature and the “round trip” function, which configures journeys based on time, distance or stopover. The circular polarization filter (CPOL) on the display minimizes reflection and improves contrast, ensuring the screen is easy to read, even in direct sunlight. 16 GB of flash storage, and the ability to stream music from your smartphone, are the ultimate luxury.

Thanks to Bluetooth® technology, the sophisticated BMW Motorrad Navigator Street (with easy-to-read 4.3" display) is compatible with the optional BMW Motorrad communication system and comes with a host of handy features.

BMW Motorrad navigation devices and the BMW Motorrad smartphone cradle can only be mounted using the BMW Motorrad navigation device bracket.

For more detailed information, contact your BMW Motorrad dealership or go online at [bmw-motorrad.com](http://bmw-motorrad.com).

#### PART NUMBERS

**BMW Motorrad Navigator VI with cradle mount**  
(top image)

Order number: 77 52 8 355 749\*

**BMW Motorrad Navigator VI** (without map data)

Order number: 77 52 8 356 005\*

(+) 4-button cradle mount

Order number: 77 52 8 544 464\*

**BMW Motorrad Navigator Street**  
(bottom image)

Order number: 77 52 8 557 855\*

**BMW Motorrad navigation systems**

Order number: 77 52 7 724 487

Mounting instructions are available from your BMW Motorrad dealership.

(+) Handlebar clamping screw M8x30 (four required)

Order number: 32 71 7 652 161

**Car mounting kit for Navigator VI**

Order number: 77 52 8 544 460\*

### BMW MOTORRAD SMARTPHONE CRADLE

Now you can charge your phone out on the road with BMW Motorrad's waterproof smartphone cradle. Charging takes place wirelessly or via a plug-in connection. The display and navigation functions are perfectly positioned in your field of vision and can be easily operated from the cradle. For smartphones with 5" displays or smaller. Max. dimensions: 13.8 cm x 7.3 cm x 1.1 cm. Only in combination with bracket for BMW Motorrad navigation devices.

#### PART NUMBER

**BMW Motorrad smartphone cradle**

Order number: 77 52 8 563 125\*

(+) = “and” – this item must be ordered at the same time  
(o) = “or” – this item may be ordered as an alternative option

## SAFETY

### ANTI-THEFT ALARM SYSTEM

If the motorcycle is moved or struck violently, the system responds with a clearly audible signal and a flashing warning light.

To be fitted and/or enabled in a specialist workshop, and ideally at your BMW Motorrad dealership.



#### PART NUMBERS

**Anti-theft alarm system**

Order number: 77 53 8 554 348\*

(+) Bracket for anti-theft alarm system

Order number: 65 75 8 524 382\*

(+) Expanding rivet (two required)

Order number: 51 49 7 054 361\*

(+) Screw

Order number: 51 13 1 960 840\*

### DYNAMIC TRACTION CONTROL (DTC), ADJUSTABLE (NOT SHOWN)

For more detailed information, contact your BMW Motorrad dealership or go online at [bmw-motorrad.com](http://bmw-motorrad.com).

To be fitted and/or enabled in a specialist workshop, and ideally at your BMW Motorrad dealership.

### PRO RIDING MODES (NOT SHOWN)

For more detailed information, contact your BMW Motorrad dealership or go online at [bmw-motorrad.com](http://bmw-motorrad.com).

To be fitted and/or enabled in a specialist workshop, and ideally at your BMW Motorrad dealership.

Only available in conjunction with Dynamic Traction Control (DTC).

\* Original BMW Motorrad equipment is available from your BMW Motorrad dealer.

## EQUIPMENT FOR THE R 1200 R



## HP PARTS

### MILLED FOOT PEGS, ADJUSTABLE (INCLUDING FOOTBRAKE AND GEAR LEVER)

Riders can adjust the high-quality CNC-milled driver foot pegs to any of three settings, keeping their feet comfortably and securely in position. Footbrake and gear levers can be adjusted to accommodate different leg lengths and even different boot sizes. To be fitted and/or enabled in a specialist workshop, and ideally at your BMW Motorrad dealership.

#### PART NUMBERS

**HP milled foot peg, left, adjustable** (image 1)  
Order number: 77 25 8 552 071\*  
(+) **HP milled foot peg, right, adjustable** (image 2)  
Order number: 77 25 8 552 072\*



(+) = "and" – this item must be ordered at the same time  
(o) = "or" – this item may be ordered as an alternative option



### HP MILLED BRAKE AND CLUTCH LEVERS

The CNC-milled HP hand levers made from corrosion-resistant, anodized aluminium are adjustable via a screw mechanism (brake lever 5 positions, clutch lever 3 positions). To be fitted and/or enabled in a specialist workshop, and ideally at your BMW Motorrad dealership.

#### PART NUMBERS

**HP milled clutch lever** (image 1)  
Order number: 77 25 8 554 323\*  
(+) **HP milled brake lever** (image 2)  
Order number: 77 25 8 554 324\*



### HP SPORT SILENCER

Made entirely out of titanium and stainless steel and to an exceptional level of craftsmanship, this slip-on silencer with carbon end-cap and heat guard delivers a powerful rumble. It's also remarkably lightweight (1 kg lighter than standard version).

#### PART NUMBERS

**HP sport silencer**  
Order number: 77 11 8 394 783\*  
Mounting instructions are available from your BMW Motorrad dealership.  
(+) **Carbon heat guard without centre stand**  
Order number: 77 11 8 554 341\*  
(o) **Carbon heat guard with centre stand**  
Order number: 77 11 8 556 703\*



\* Original BMW Motorrad equipment is available from your BMW Motorrad dealer.



## STORAGE



### SMALL TOP BOX AND BACKREST PAD

The waterproof top box has a capacity of 30 l and a maximum load of 5 kg – perfect for a helmet, for example. The lid comes with paintwork in Granite Grey Metallic and a soft-close mechanism; backrest pad and central locking functionality are also available upon request. Recommended maximum speed 180 km/h. For information on speed and load limitations, please refer to the instruction booklet.

#### PART NUMBERS

**Touring pannier, left**

Order number: 77 41 8 536 869\*

**Touring pannier, right**

Order number: 77 41 8 536 870\*

(+) Mounting kit

Order number: 71 60 7 680 840\*

(+) Locking cylinder (with codes) for central locking with motorcycle

Order number: 51 25 7 681 200\*

(o) Repair kit for locking cylinder

Order number: 51 25 7 698 204\*

Mounting parts and locking cylinder variant (one required per pannier)

**Backrest pad**

Order number: 77 44 8 549 337



### SMALL TANKBAG

The capacity of the waterproof main compartment is expandable from 5 to 9 l. The high-quality waterproof map pocket comes with non-slip polyurethane coating. With additional water-repellent exterior pockets, carry handle and adjustable shoulder strap.

#### PART NUMBER

**Small tankbag**

Order number: 77 45 8 556 293\*

### PANNIER RACKS

These sturdy pannier racks blend in perfectly with the vehicle's overall design – even when the panniers have been removed – and firmly secure the touring panniers, quickly and easily.

#### PART NUMBERS

**Pannier racks**

Order number: 46 54 8 534 255\*

To be fitted and/or enabled in a specialist workshop, and ideally at your BMW Motorrad dealership.

(+) Cylinder screw M8x25 (four required)

Order number: 07 12 9 907 382\*

(+) ISA screw M8x40 (two required)

Order number: 07 12 9 904 704\*

(+) Mushroom-head fixing screw (two required)

Order number: 46 54 8 534 265\*



### INNER BAG FOR SMALL TOP BOX

Makes loading and unloading a top box even easier. The inner bag comes with a practical carry handle and can be folded flat when not in use.

#### PART NUMBER

**Inner bag for top box**

Order number: 77 43 8 549 130\*

### TOURING PANNIERS

Sturdy, splash-proof touring panniers with pannier lid paintwork in Granite Grey Matt Metallic provide total storage capacity of approx. 63 l (approx. 32 l left, 31 l right). Each pannier can hold a 10 kg load. The left pannier has ample space for one helmet. Pannier base can be expanded for easier loading and unloading. Recommended maximum speed 180 km/h. For information on speed and load limitations, please refer to the instruction booklet.

#### PART NUMBERS

**Touring pannier, left**

Order number: 77 41 8 536 869\*

**Touring pannier, right**

Order number: 77 41 8 536 870\*

(+) Mounting kit

Order number: 71 60 7 680 840\*

(+) Locking cylinder (with codes) for central locking with motorcycle

Order number: 51 25 7 681 200\*

(o) Repair kit for locking cylinder

Order number: 51 25 7 698 204\*

Mounting parts and locking cylinder variant (one required per pannier)



### INNER BAGS FOR TOURING PANNIERS

These practical, water-resistant inner bags make full use of the capacity of the touring panniers. Luggage can be accessed easily with one hand, and the bag can even be worn over the shoulder thanks to a detachable strap.

#### PART NUMBERS

**Inner bag for touring pannier, left**

Order number: 77 41 8 549 407\*

**Inner bag for touring pannier, right**

Order number: 77 41 8 549 408\*



### LUGGAGE GRID

A secure base for the small top box, suitable for use with the BMW R 1200 R. Paintwork in Granite Grey Matt Metallic.

To be fitted and/or enabled in a specialist workshop, and ideally at your BMW Motorrad dealership.

For information on speed and load limitations, please refer to the instruction booklet.

#### PART NUMBERS

**Luggage grid**

Order number: 46 54 8 534 258\*

(+) Luggage grid lower section

Order number: 46 54 8 534 264\*

(+) Luggage grid lower section, Granite Grey Matt Metallic

Order number: 46 54 8 556 661\*

(+) Attachments for luggage grid

Order number: 77 44 8 546 695\*



## DESIGN



### LED INDICATORS

Cutting-edge design inside and out. The LED indicators complement the design of the BMW R 1200 R perfectly – and thanks to reduced energy consumption and significantly longer bulb life, they're also a shining example of efficiency.

To be fitted and/or enabled in a specialist workshop, and ideally at your BMW Motorrad dealership.

### PART NUMBERS

**LED indicators** (three required)

Order number: 63 13 8 522 499\*

(+) LED indicators, rear (one required)

Order number: 63 13 8 522 503\*

### PLASTIC ENGINE SPOILER IN BIKE COLOUR (NOT SHOWN)

The elegant engine spoiler underlines the refined, dynamic look of the BMW R 1200 R.

To be fitted and/or enabled in a specialist workshop, and ideally at your BMW Motorrad dealership.

Not available in conjunction with engine protection bar.

### PART NUMBERS

**HP engine spoiler, Light White, left**

Order number: 46 63 8 550 459\*

(+) HP engine spoiler, Light White, right

Order number: 46 63 8 550 460\*

(+) Bracket (left) for engine spoiler

Order number: 46 63 8 546 955\*

(+) Bracket (right) for engine spoiler

Order number: 46 63 8 546 956\*

## ERGONOMICS & COMFORT



### RIDER AND PILLION SEATS

The choice is yours. We make seats that give you the perfect knee angle, lower seats that allow you to keep the ground within easy reach, and padded seats for greater comfort. All rider seats are also available ex works. You can even have the pillion seat adjusted accordingly.

### PART NUMBERS

**High rider seat, Black** (image 1)

(seat height: 820 mm, step length: 1,835 mm)

Order number: 52 53 8 534 318\*

**Rider seat, Black** (not shown)

(seat height: 790 mm, step length: 1,780 mm)

Order number: 52 53 8 534 316\*

**Low rider seat, Black** (image 2)

(seat height: 760 mm, step length: 1,720 mm)

Order number: 52 53 8 534 317\*

**Pillion seat** (not shown)

Order number: 52 53 8 534 319\*

**Comfort pillion seat** (not shown)

Order number: 52 53 8 534 320\*

### WINDSHIELDS

The sport windshield significantly reduces wind pressure on the body, and the tinted variant adds an extra sporty touch to the bike. The high windshield (80 mm higher and 45 mm broader) provides greater comfort, especially on long motorway journeys or when touring.

To be fitted and/or enabled in a specialist workshop, and ideally at your BMW Motorrad dealership.

### PART NUMBERS

**Sport windshield, clear** (image 1)

Order number: 46 63 8 534 281\*

(o) **Sport windshield, tinted** (image 2)

Order number: 77 33 8 544 629\*

(o) **High windshield, clear** (image 3)

Order number: 77 33 8 534 283\*

(+) Windshield bracket

Order number: 46 63 8 555 087\*





**SPORT RIDER SEAT, BLACK**

The high and narrow sport rider seat facilitates an active body position for more dynamic riding. Even taller riders will feel at home on it.

**PART NUMBER**

**Sport rider seat, Black**  
(seat height: 840mm, step length: 1,875mm)  
Order number: 77 34 8 555 886\*



**CENTRE STAND**

The sturdy centre stand ensures that the bike remains stable even on loose surfaces. To be fitted and/or enabled in a specialist workshop, and ideally at your BMW Motorrad dealership.

**Small mounting parts are not included.**

**PART NUMBER**

**Centre stand**  
Order number: 46 52 8 532 725\*



**HEATED GRIPS AND SWITCHES**

Warm hands feel good, which is why these heated handlebar grips have two settings designed to keep hands and fingers pleasantly warm.

For more detailed information, contact your BMW Motorrad dealership or go online at [bmw-motorrad.com](http://bmw-motorrad.com).

To be fitted and/or enabled in a specialist workshop, and ideally at your BMW Motorrad dealership.

**CRUISE CONTROL (NOT SHOWN)**

For more detailed information, contact your BMW Motorrad dealership or go online at [bmw-motorrad.com](http://bmw-motorrad.com).

To be fitted and/or enabled in a specialist workshop, and ideally at your BMW Motorrad dealership.

**PRO GEAR-SHIFT ASSIST (NOT SHOWN)**

Change gears without using the clutch.

To be fitted and/or enabled in a specialist workshop, and ideally at your BMW Motorrad dealership.

**PART NUMBERS**

**Pro gear-shift assist**  
Order number: 23 41 8 536 884\*  
(+) Enabling code for Pro gear-shift assist  
Order number: 13 61 8 545 879\*

**NAVIGATION AND COMMUNICATION**



**BMW MOTORRAD NAVIGATION SYSTEMS**

Where am I? Where do I want to go, and what's the most scenic way to get there? BMW Motorrad navigation devices show you where to go. Made specifically for motorcyclists, they're easy to fit and use – even with gloves on – and come with lifetime map updates.

The new BMW Motorrad Navigator VI is your ticket to the tour of your dreams. A whole new level of adventure awaits thanks to the "winding roads" route option, "avoid motorways" feature and the "round trip" function, which configures journeys based on time, distance or stopover. The circular polarization filter (CPOL) on the display minimizes reflection and improves contrast, ensuring the screen is easy to read, even in direct sunlight. 16 GB of flash storage, and the ability to stream music from your smartphone, are the ultimate luxury.

For more detailed information, contact your BMW Motorrad dealership or go online at [bmw-motorrad.com](http://bmw-motorrad.com).

Only available in conjunction with "Navigation device preparation" (also available as an equipment option, option code 272)

"My motorcycle" page only available in conjunction with Pro on-board computer.

**PART NUMBERS**

**BMW Motorrad Navigator VI**  
(with map data for Europe)  
Order number: 77 52 8 355 994\*

**(o) BMW Motorrad Navigator VI** (without map data)  
Order number: 77 52 8 356 005\*

(+) Retrofit preparation for navigation device  
Order number: 77 52 8 555 507\*

## SAFETY



### STAINLESS STEEL CYLINDER HEAD COVER GUARD

If the worst comes to the worst, the cylinder head cover guard provides comprehensive protection against damage. Plastic contact guard is replaceable.

Mounting instructions are available from your BMW Motorrad dealership.

#### PART NUMBER

**Cylinder head cover guard**  
Order number: 77 14 8 533 745\*



### SAFETY SCREW FOR OIL FILLER CAP

Small, yet refined: this small safety screw is made of milled aluminium and prevents unauthorized removal of the oil filler cap.

#### PART NUMBER

**Safety screw for oil filler cap**  
Order number: 71 60 7 696 117\*



### STAINLESS STEEL ENGINE PROTECTION BAR

The stainless steel engine protection bar provides effective protection for the cylinders without compromising the lean angle.

Mounting instructions are available from your BMW Motorrad dealership.

Not for use in conjunction with the engine spoiler.

#### PART NUMBER

**Engine protection bar, left**  
Order number: 77 14 8 557 607\*

**Engine protection bar, right**  
Order number: 77 14 8 557 608\*

(+) Mounting parts  
Order number: 77 14 8 522 926\*

(+) Cylinder screw M8x30 (two required)  
Order number: 07 14 9 907 381\*

(+) Cylinder screw M8x35 (two required)  
Order number: 07 14 9 908 654\*



### LED AUXILIARY HEADLIGHTS

The LED auxiliary headlights deliver increased safety when visibility is poor, e.g. in fog, snow and rain. To be fitted and/or enabled in a specialist workshop, and ideally at your BMW Motorrad dealership.

The auxiliary headlights are approved for use as fog lights, and may only be used in poor weather conditions. Country-specific road traffic regulations apply.

#### PART NUMBERS

**LED auxiliary headlights** (two required)  
Order number: 63 17 8 556 937\*

(+) Bracket for LED auxiliary headlights  
Order number: 77 51 8 551 341\*

(+) Cable harness for auxiliary headlights  
Order number: 61 12 8 548 710\*

(+) Additional switch for auxiliary headlights  
Order number: 61 31 8 533 473\*

(+) Cable clamp  
Order number: 32 72 8 534 366\*

### PRO RIDING MODES (NOT SHOWN)

Also available as an equipment option. For more detailed information, contact your BMW Motorrad dealership or go online at [bmw-motorrad.com](http://bmw-motorrad.com).

To be fitted and/or enabled in a specialist workshop, and ideally at your BMW Motorrad dealership.

Only available in conjunction with Dynamic Traction Control (DTC).

### ANTI-THEFT ALARM SYSTEM (NOT SHOWN)

If the motorcycle is moved or struck violently, the system responds with a clearly audible signal and a flashing warning light.

To be fitted and/or enabled in a specialist workshop, and ideally at your BMW Motorrad dealership.

#### PART NUMBERS

**Anti-theft alarm system (DWA)**

Order number: 77 53 8 554 348\*

(+) Oval head screw

Order number: 51 13 1 960 840\*



\* Original BMW Motorrad equipment is available from your BMW Motorrad dealer.



**WHATEVER  
HAPPENS:  
KEEP RIDING.  
THERE ARE NO  
WRONG WAYS.  
ONLY DETOURS.**

<b>G 310 GS</b>	_____	170
<b>F 750 GS</b>	_____	176
<b>F 850 GS</b>	_____	186
<b>F 800 GS Adventure</b>	_____	198
<b>S 1000 XR</b>	_____	206
<b>R 1200 GS</b>	_____	218
<b>R 1200 GS Adventure</b>	_____	232



## EQUIPMENT FOR THE BMW G 310 GS



## STORAGE



### LIGHT TOP BOX, 29L

The 29 l top box offers all the space you need for everyday trips and short tours. There's even space for a helmet. Includes locking cylinder. Mounting instructions are available from your BMW Motorrad dealership.

#### PART NUMBERS

**Light top box, 29l**  
Order number: 77 43 8 566 126  
(+) Badge  
Order number: 51 14 2 328 447

(+) = "and" – this item must be ordered at the same time  
(o) = "or" – this item may be ordered as an alternative option



### TOP BOX, 30L

The waterproof top box has a capacity of 30 l and a maximum load of 5 kg – perfect for a helmet, for example. The lid has a smooth painted finish and a soft-close mechanism. Model shown: BMW S 1000 XR.

#### PART NUMBERS

**Top box, 30l**  
Order number: 77 43 8 543 246  
(+) Top box lid outer shell in Granite Grey Matt Metallic  
Order number: 77 43 8 553 127  
(o) Top box lid outer shell in Racing Red (not shown)  
Order number: 77 43 8 555 607  
(+) Badge  
Order number: 31 42 7 708 518  
(+) Raised head screw (six required)  
Order number: 07 14 7 698 893  
(+) Locking cylinder for top box with 2 keys  
Order number: 51 25 7 688 957

### INNER BAG FOR LIGHT TOP BOX (29L) AND TOP BOX (30L)

Makes loading and unloading a top box even easier. The inner bag comes with a practical carry handle and can be folded flat when not in use.

#### PART NUMBER

**Inner bag for top box**  
Order number: 77 43 8 549 130



### TANKBAG

The capacity of the main compartment can be expanded from 13 to 20l. Extra space is available in the map pocket and two exterior pockets. A waterproof rain cover keeps everything dry, while sophisticated and highly practical fasteners hold everything securely in place.

#### PART NUMBER

**Tank bag, 13–20l**  
Order number: 77 45 2 450 396

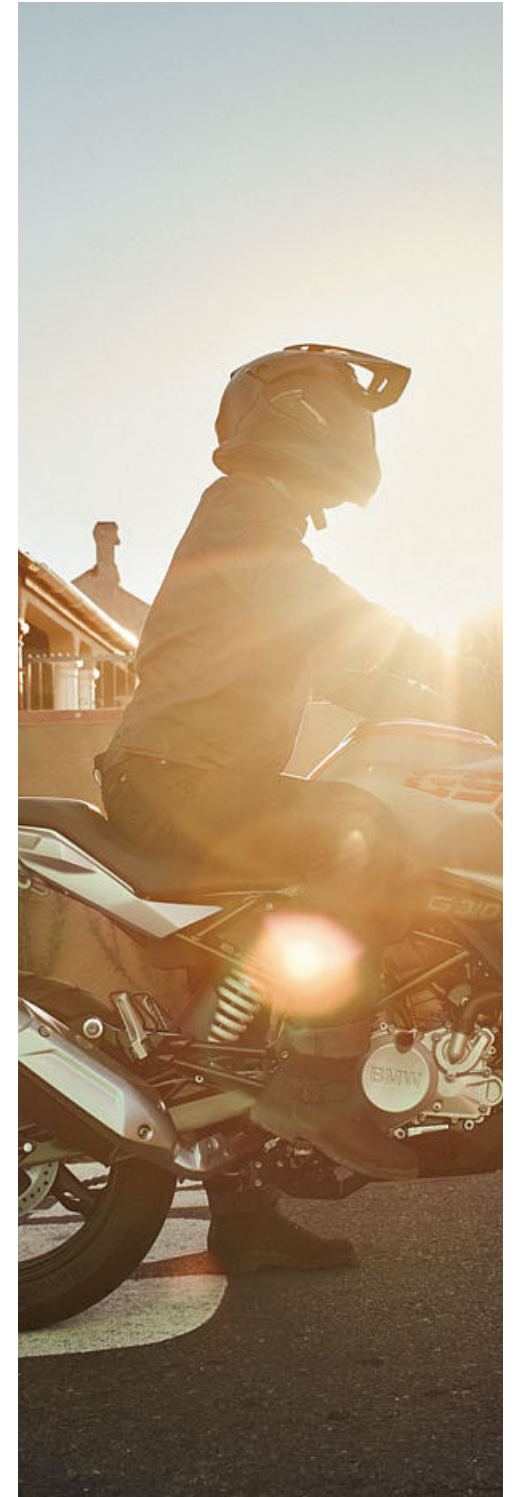

\* Original BMW Motorrad equipment is available from your BMW Motorrad dealer.

## ERGONOMICS & COMFORT



### HIGH AND LOW SEATS

The high padded seat provides a more comfortable raised seating position for taller riders. The low seat (15 mm lower) makes handling and climbing on easier.



#### PART NUMBER

##### High seat

(seat height: 850 mm; step length: 1,900 mm)  
Order number: 77 34 8 562 491

##### Low seat

(seat height: 820 mm; step length: 1,840 mm)  
Order number: 52 53 8 562 135

### HEATED GRIPS (NOT SHOWN)

Warm hands feel good, which is why these heated handlebar grips have two settings designed to keep hands and fingers pleasantly warm.

To be fitted and/or enabled in a specialist workshop, and ideally at your BMW Motorrad dealership.  
For more detailed information, contact your BMW Motorrad dealership or go online at [bmw-motorrad.com](http://bmw-motorrad.com).

#### PART NUMBER

##### Heated grips and switches

Order number: 77 52 8 388 676

## NAVIGATION AND COMMUNICATION



### BMW MOTORRAD NAVIGATION SYSTEMS

Where am I? Where do I want to go, and what's the most scenic way to get there? BMW Motorrad navigation devices show you where to go. Made specifically for motorcyclists, they're easy to fit and use – even with gloves on – and come with lifetime map updates. Thanks to Bluetooth® technology, the sophisticated BMW Motorrad Navigator Street (with easy-to-read 4.3" display) is compatible with the optional BMW Motorrad communication system and comes with a host of handy features. The new BMW Motorrad Navigator VI is your ticket to the tour of your dreams. A whole new level of adventure awaits thanks to the "winding roads" route option, "avoid motorways" feature and the "round trip" function, which configures journeys based on time, distance or stopover. The circular polarization filter (CPOL) on the display minimizes reflection and improves contrast, ensuring the screen is easy to read, even in direct sunlight. 16 GB of flash storage, and the ability to stream music from your smartphone, are the ultimate luxury.

For more detailed information, contact your BMW Motorrad dealership or go online at [bmw-motorrad.com](http://bmw-motorrad.com).

Only in combination with bracket for BMW Motorrad navigation devices.

#### PART NUMBER

##### BMW Motorrad Navigator Street

Order number: 77 52 8 557 855

##### BMW Motorrad Navigator VI with cradle mount (with map data for Europe)

Order number: 77 52 8 355 749

##### BMW Motorrad Navigator VI (without map data)

Order number: 77 52 8 356 005

(+) 4-button cradle mount

Order number: 77 52 8 544 464\*



### BMW MOTORRAD SMARTPHONE CRADLE

Now you can charge your phone out on the road with BMW Motorrad's waterproof smartphone cradle. Charging takes place wirelessly or via a plug-in connection. The display and navigation functions are perfectly positioned in your field of vision and can be easily operated from the cradle. For smartphones with 5" displays or smaller. Max. dimensions: 13.8 cm x 7.3 cm x 1.1 cm.

For more detailed information, contact your BMW Motorrad dealership or go online at [bmw-motorrad.com](http://bmw-motorrad.com). Only in combination with bracket for BMW Motorrad navigation devices.



#### PART NUMBER

**BMW Motorrad smartphone cradle**  
Order number: 77 52 8 563 125

### BRACKET FOR BMW MOTORRAD NAVIGATION DEVICES (NOT SHOWN)

A bracket to hold BMW Motorrad navigation devices or the smartphone cradle in place. It also provides a power supply.

For more detailed information, contact your BMW Motorrad dealership or go online at [bmw-motorrad.com](http://bmw-motorrad.com). Only in combination with bracket for BMW Motorrad navigation devices.

#### PART NUMBER

**Bracket for BMW Motorrad navigation devices**  
Order number: 77 52 8 388 827

(+) Adapter cable  
Order number: 61 12 8 388 829  
Required for vehicles without heated grips.

(+) = "and" – this item must be ordered at the same time  
(o) = "or" – this item may be ordered as an alternative option

## DESIGN

### LED INDICATORS

Cutting-edge design inside and out. The LED indicators complement the design of the BMW G 310 GS perfectly – and thanks to reduced energy consumption and significantly longer bulb life, they're also a shining example of efficiency.

To be fitted and/or enabled in a specialist workshop, and ideally at your BMW Motorrad dealership.

#### PART NUMBER

**LED indicators** (four required)  
Order number: 63 13 8 522 499



\* Original BMW Motorrad equipment is available from your BMW Motorrad dealer.





## EQUIPMENT FOR THE BMW F 750 GS.



## HP PARTS.

### HP SPORT SILENCER

Finely handcrafted, this slip-on silencer delivers a powerful sound and is remarkably lightweight. Approx. 2.35 kg lighter than the standard rear silencer. The end piece has a single-flute design and a carbon end cap. Power and torque are at the production level. The lasered Akrapovič is located on the side surface. HP lettering. With road traffic approval (EU-ABE). Also available as an equipment option.

To be fitted and/or enabled in a specialist workshop, and ideally at your BMW Motorrad dealership.

#### PART NUMBER

##### HP sport silencer

Order number: 77 11 8 569 434



(+) = "and" – this item must be ordered at the same time  
(o) = "or" – this item may be ordered as an alternative option

## STORAGE.



### VARIABLE PANNIERS

The variable panniers are fitted with a patented adjustment system. The volume allows their capacity to be reduced from 68l (39l left, 29l right) to 50l (30l left, 20l right). This is particularly useful in city traffic, because the width is reduced by 120mm.

Not available in conjunction with pannier racks.

### ALUMINIUM TOP BOX AND BACKREST PAD

The watertight variable top box can be secured to the top box holder using the stainless steel luggage grid. As with the variable panniers, the capacity is adjustable, and can be expanded from 25 to 35 litres quickly and easily by moving a bar inside. An optional backrest pad provides increased comfort for the pillion passenger. Variable top box only in conjunction with top box holder.



#### PART NUMBER

##### Variable pannier, left

Order number: 77 40 8 569 659

##### Variable pannier, right

Order number: 77 40 8 569 660

(+) Repair kit for locking cylinder (one required for each pannier)

Order number: 77 49 8 404 528

#### PART NUMBER

##### Variable top box

Order number: 77 43 8 569 672

(+) Repair kit for locking cylinder (one required for each pannier)

Order number: 77 49 8 404 528

##### Backrest pad for variable top box

Order number: 71 60 7 688 877



### PANNIER HOLDERS FOR VARIABLE PANNIERS

These sturdy pannier racks blend in perfectly with the vehicle's overall concept, providing a firm, secure hold for the touring panniers quickly and easily. Also available as an equipment option.

#### PART NUMBER

##### Pannier racks for variable panniers

Order number: 77 42 8 405 343

(+) Screw M8x30 MK (four required)

Order number: 07 12 9 908 487

\* Original BMW Motorrad equipment is available from your BMW Motorrad dealer.



**TOP BOX HOLDER FOR VARIABLE TOP BOX**

The robust stainless steel luggage grid with top box holder replaces the standard plastic luggage grid. Also available as an equipment option in conjunction with the pannier holders.

**PART NUMBERS**

- Top box holder for variable top box**  
Order number: 46 54 8 404 578
- (+) Cylinder screw (two required)  
Order number: 07 12 9 908 466
- (+) Cylinder screw (two required)  
Order number: 07 12 9 907 381



**TANKBAG AND MAP POCKET**

The tankbag is not just an ideal companion on day trips for small luggage. Thanks to the all-round stabilising functional aluminium frame, the optional waterproof DIN A4 map pocket or additional luggage can also be attached to it. An integrated waterproof rain cover keeps everything dry,

**PART NUMBERS**

- Tankbag, 8l – 14l**  
Order number: 77 45 2 449 425
- Map pocket for tankbag**  
Order number: 77 45 2 457 813

**INNER BAGS FOR VARIABLE PANNIER AND VARIABLE TOP BOX**

These practical inner bags make it easier to load and unload the panniers and top box. Just like the panniers and top box, their capacity is adjustable thanks to an all-round zip.

**PART NUMBERS**

- Inner bag for variable pannier, left**  
Order number: 77 49 8 536 210
- Inner bag for variable pannier, right**  
Order number: 77 49 8 534 711
- Inner bag for variable top box**  
Order number: 77 49 8 534 712



**BAG FOR PILLION SEAT**

This waterproof bag attaches to the pillion seat and offers 2.5l of extra storage expandable to 8l – just the right amount for day trips or even the daily commute. Along with the tankbag, it's the perfect way to add storage space.

**PART NUMBERS**

- Bag for pillion seat, 2.5l – 8l**  
Order number: 77 45 2 456 667



(+) = "and" – this item must be ordered at the same time  
(o) = "or" – this item may be ordered as an alternative option

**DESIGN.**



**LED INDICATORS**

The LED indicators complement the design of the BMW F 750 GS perfectly – and thanks to reduced energy consumption and significantly longer bulb life, they're also a shining example of efficiency. Also available as an equipment option. To be fitted and/or enabled in a specialist workshop, and ideally at your BMW Motorrad dealership.

**PART NUMBER**

- LED indicators, front (two required)**  
Order number: 63 13 8 522 499
- (+) LED indicators, rear (two required)  
Order number: 63 23 8 522 500



\* Original BMW Motorrad equipment is available from your BMW Motorrad dealer.

## ERGONOMICS AND COMFORT.



### WINDSHIELDS

The small standard windshield provides good wind and weather protection, and in the tinted option gives the vehicle a sporty look. The large windshield offers optimum touring comfort in wind and weather and the tinted version underscores the sporty design of the BMW F 750 GS. All windshields are anti-scratch coated. To be fitted and/or enabled in a specialist workshop, and ideally at your BMW Motorrad dealership.

#### PART NUMBER

**Small windshield, tinted** (image 1)  
Order number: 77 33 8 566 472

**Large windshield, clear** (image 2)  
Order number: 77 33 8 566 473

(+) Windshield holder (not shown)  
Order number: 46 63 8 564 649

**Large windshield, tinted** (image 3)  
Order number: 77 33 8 566 474

(+) Windshield holder (not shown)  
Order number: 46 63 8 564 649

#### PART NUMBER

**Handlebar riser, left**  
Order number: 32 71 8 357 485

(+) Handlebar riser, right  
Order number: 32 71 8 569 750

(+) Cylinder screw (four required)  
Order number: 07 12 9 907 377

### HANDLEBAR RISER (NOT SHOWN)

The handlebar riser of 15 mm not only enables an upright and comfortable sitting position, but also facilitates safe handling of the motorcycle when driving in a standing position off-road.

To be fitted and/or enabled in a specialist workshop, and ideally at your BMW Motorrad dealership.

Not available in conjunction with option code 272 "Navigation device preparation" and "Smartphone cradle holder".



### ENDURO FOOT PEGS

On off-road terrain, these wider, longer Enduro foot pegs ensure better control while allowing riders to comfortably use the gear and foot brake levers.

To be fitted and/or enabled in a specialist workshop, and ideally at your BMW Motorrad dealership.

#### PART NUMBER

**Enduro foot peg, left**  
Order number: 46 71 8 409 497

(+) Enduro foot peg, right  
Order number: 46 71 8 409 498

(+) Foot peg torsion spring (two required)  
Order number: 46 71 8 526 107



### TWO-COLOURED SEATS

The two-tone benches of the BMW F 750 GS are available in standard seat height as well as in the low version for easier boarding and handling. Seat available in low version and as an equipment option.

#### PART NUMBER

**Seat, Black/Red** (image 1)  
(seat height: 815 mm; step length: 1,830 mm)  
Order number: 52 53 8 564 837

**Seat, Black/Grey** (image 2)  
(seat height: 815 mm; step length: 1,830 mm)  
Order number: 52 53 8 393 857

**Low seat, Black/Red** (image 3)  
(seat height: 790 mm; step length: 1,790 mm)  
Order number: 52 53 8 564 838

**Low seat, Black/Grey** (image 4)  
(seat height: 790 mm; step length: 1,790 mm)  
Order number: 77 33 8 566 474



### RALLYE SEAT

The narrow width of the Rallye seat keeps the ground within easy reach, making it ideal for off-road riding. It also comes with a raised seat position and firmer padding.

For more detailed information, contact your BMW Motorrad dealership or go online at [bmw-motorrad.com](http://bmw-motorrad.com).

#### PART NUMBER

**Rallye seat**  
(seat height: 845 mm; step length: 1,900 mm)  
Order number: 77 34 8 564 840



### COMFORT SEAT

Climb on and feel at ease. The comfort seat is especially appreciated on longer tours, for both the rider and pillion passenger. Also available as an equipment option.

#### PART NUMBER

**Comfort seat**  
(seat height: 830 mm/step length: 1,870 mm)  
Order number: 52 53 8 564 839



### ADJUSTABLE GEAR LEVER

Provides improved control when standing. With adjustable toe piece.

To be fitted and/or enabled in a specialist workshop, and ideally at your BMW Motorrad dealership.

#### PART NUMBER

**Adjustable gear lever**  
Order number: 23 41 8 373 977



**ADJUSTABLE FOOTBRAKE LEVER**

The wider and height-adjustable foot brake lever has a patented folding mechanism. This makes it easier to reach and the brake pressure can be adjusted more precisely when driving off-road. To be fitted and/or enabled in a specialist workshop, and ideally at your BMW Motorrad dealership.

**PART NUMBER**

**Adjustable footbrake lever**  
Order number: 35 21 8 569 755

**HEATED GRIPS AND SWITCHES (NOT SHOWN)**

Warm hands feel good, which is why these heated handlebar grips have two settings designed to keep hands and fingers pleasantly warm. Also available as an equipment option. To be fitted and/or enabled in a specialist workshop, and ideally at your BMW Motorrad dealership.

To be fitted and/or enabled in a specialist workshop, and ideally at your BMW Motorrad dealership.

**CENTRE STAND (NOT SHOWN)**

The sturdy centre stand ensures that the bike remains stable even on loose surfaces. Also available as an equipment option. Not available in conjunction with No. 499 lowered suspension option.

To be fitted and/or enabled in a specialist workshop, and ideally at your BMW Motorrad dealership.

For more detailed information, contact your BMW Motorrad dealership or go online at [bmw-motorrad.com](http://bmw-motorrad.com).

**PART NUMBER**

**Centre stand**  
Order number: 46 52 8 358 264

(+) Mounting kit  
Order number: 77 25 8 409 390

(+) Bumper  
Order number: 46 52 2 332 218

(+) Bumper stop (three required)  
Order number: 31 42 8 537 724

**PART NUMBER**

**Heated grip, left**  
Order number: 61 31 8 552 117

(+) Heated grip, right  
Order number: 61 31 8 552 118

(+) Multifunction switch, right  
Order number: 61 31 8 394 246

**PRO GEAR-SHIFT ASSIST (NOT SHOWN)**

Delivers smooth shifts up and down without the use of the clutch. Also available as an equipment option. To be fitted and/or enabled in a specialist workshop, and ideally at your BMW Motorrad dealership.

To be fitted and/or enabled in a specialist workshop, and ideally at your BMW Motorrad dealership.

**PART NUMBER**

**Pro gear-shift assist**  
Order number: 23 41 8 522 869

(+) Enabling code for Pro gear-shift assist  
Order number: 13 61 8 545 879

**NAVIGATION AND COMMUNICATIONS.**



**BMW MOTORRAD NAVIGATION SYSTEMS**

Where am I? Where do I want to go, and what's the most scenic way to get there? BMW Motorrad navigation devices show you where to go. Made specifically for motorcyclists, they're easy to fit and use – even with gloves on – and come with lifetime map updates. The new BMW Motorrad Navigator VI is your ticket to the tour of your dreams. A whole new level of adventure awaits thanks to the "curvy roads" route option, "avoid motorways" feature and the "round trip" function, which configures journeys based on time, distance or stopover. The circular polarization filter (CPOL) on the display minimizes reflection and improves contrast, ensuring the screen is easy to read, even in direct sunlight. 16 GB of flash storage, and the ability to stream music from your smartphone, are the ultimate luxury. For more detailed information, contact your BMW Motorrad dealership or go online at [bmw-motorrad.com](http://bmw-motorrad.com). BMW Motorrad navigation systems only available in conjunction with optional navigation device preparation.

The new BMW Motorrad Navigator VI is your ticket to the tour of your dreams. A whole new level of adventure awaits thanks to the "curvy roads" route option, "avoid motorways" feature and the "round trip" function, which configures journeys based on time, distance or stopover. The circular polarization filter (CPOL) on the display minimizes reflection and improves contrast, ensuring the screen is easy to read, even in direct sunlight. 16 GB of flash storage, and the ability to stream music from your smartphone, are the ultimate luxury. For more detailed information, contact your BMW Motorrad dealership or go online at [bmw-motorrad.com](http://bmw-motorrad.com). BMW Motorrad navigation systems only available in conjunction with optional navigation device preparation.

**PART NUMBER**

**BMW Motorrad Navigator VI with cradle mount (with map data for Europe)**  
Order number: 77 52 8 355 994

(o) BMW Motorrad Navigator VI (without map data)  
Order number: 77 52 8 356 005



**BMW MOTORRAD SMARTPHONE CRADLE**

Now you can charge your phone out on the road with BMW Motorrad's waterproof smartphone cradle. Charging takes place wirelessly or via a plug-in connection. The display and navigation functions are perfectly positioned in your field of vision and can be easily operated from the cradle. For smartphones with 5" displays or smaller. Max. dimensions: 13.8cm x 7.3cm x 1.1cm. For more detailed information, contact your BMW Motorrad dealership or go online at [bmw-motorrad.com](http://bmw-motorrad.com). Not available in conjunction with preparation for navigation device.

For more detailed information, contact your BMW Motorrad dealership or go online at [bmw-motorrad.com](http://bmw-motorrad.com). Not available in conjunction with preparation for navigation device.

**PART NUMBER**

**BMW Motorrad smartphone cradle**  
Order number: 77 52 8 563 125

(+) Smartphone cradle bracket  
Order number: 77 52 8 380 735

(+) Raised head screw (four required)  
Order number: 46 62 7 692 608

(+) Washer (four required)  
Order number: 07 11 9 904 446

(+) Screw (four required)  
Order number: 32 71 8 396 665

# SAFETY.



### HAND PROTECTORS

For effective protection against wind, rain, low branches and flying stones.  
To be fitted and/or enabled in a specialist workshop, and ideally at your BMW Motorrad dealership.  
Part of the BMW F 750 GS Exclusive version.

#### PART NUMBER

**Hand protectors**  
Order number: 77 32 8 358 957



### HEADLIGHT GUARD

The headlight guard protects the headlight from damage when riding off-road. It is not approved for road use.  
Attaches and detaches quickly and easily.  
To be fitted and/or enabled in a specialist workshop, and ideally at your BMW Motorrad dealership.

#### PART NUMBER

**Headlight guard** (for off-road use only)  
Order number: 77 51 8 356 945



### ENDURO ALUMINIUM BASH PLATE

This sturdy Enduro aluminium bash plate was specially constructed for off-road use and provides optimal protection for the lower section of the engine.  
To be fitted and/or enabled in a specialist workshop, and ideally at your BMW Motorrad dealership.  
Scheduled availability from third quarter of 2018.

#### PART NUMBER

**Enduro aluminium bash plate**  
Order number: 77 14 8 404 511  
(+) Mounting kit Enduro aluminium bash plate  
Order number: 11 84 8 544 599 I



### ENGINE PROTECTION BAR

The stainless steel engine protection bar provides effective protection for the motor housing without compromising the lean angle.  
For more detailed information, contact your BMW Motorrad dealership or go online at [bmw-motorrad.com](http://bmw-motorrad.com).  
To be fitted and/or enabled in a specialist workshop, and ideally at your BMW Motorrad dealership.  
Scheduled availability from third quarter of 2018.

#### PART NUMBER

**Engine protection bar, left**  
Order number: 77 41 8 522 927  
(+) Engine protection bar, right  
Order number: 77 41 8 522 928  
(+) Cylinder screw (three required)  
Order number: 07 12 9 908 467  
(+) Cylinder screw (two required)  
Order number: 07 12 9 908 416  
(+) Cylinder screw  
Order number: 07 12 9 908 527  
(+) Raised head screw  
Order number: 46 61 7 713 314



### LED AUXILIARY HEADLIGHTS

Increased safety in poor visibility: The LED auxiliary headlights allow you to see and be seen more effectively in fog, snow and rain.  
For more detailed information, contact your BMW Motorrad dealership or go online at [bmw-motorrad.com](http://bmw-motorrad.com).  
To be fitted and/or enabled in a specialist workshop, and ideally at your BMW Motorrad dealership.  
The auxiliary headlights are approved for use as fog lights, and may only be used in poor weather conditions. Country-specific road traffic regulations apply.

#### PART NUMBER

**LED auxiliary headlights** (two required)  
Order number: 63 17 8 556 937  
(+) Bracket for LED auxiliary headlights  
Order number: 77 51 8 356 947  
(+) Bracket for LED auxiliary headlights  
Order number: 77 51 8 524 085  
(+) Additional switch for LED auxiliary headlights  
Order number: 61 31 8 533 473 I  
(+) Cable harness for LED auxiliary headlights  
Order number: 61 12 8 404 348  
(+) Left bracket  
Order number: 32 72 8 565 051  
(+) Inner Torx screw  
Order number: 07 12 9 907 413



### PLASTIC BASH PLATE

The robust plastic bash plate protects the engine against flying stones. The necessary attachments are included.  
To be fitted and/or enabled in a specialist workshop, and ideally at your BMW Motorrad dealership.

#### PART NUMBER

**Plastic bash plate**  
Order number: 11 84 8 405 374



### ANTI-THEFT ALARM SYSTEM (NOT SHOWN)

If the motorcycle is moved or struck violently, the system responds with a clearly audible signal and a flashing warning light.  
Also available as an equipment option.  
To be fitted and/or enabled in a specialist workshop, and ideally at your BMW Motorrad dealership.

#### PART NUMBER

**Anti-theft alarm system**  
Order number: 77 53 8 554 348  
(+) Lens screw and washer  
Order number: 07 14 9 141 517

(+) = "and" – this item must be ordered at the same time  
(o) = "or" – this item may be ordered as an alternative option

\* Original BMW Motorrad equipment is available from your BMW Motorrad dealer.

## EQUIPMENT FOR THE BMW F 850 GS.



## HP PARTS.



### HP SPORT SILENCER

Finely handcrafted, this slip-on silencer delivers a powerful sound and is remarkably lightweight. Approx. 2.35 kg lighter than the standard rear silencer. The end piece has a single-flute design and a carbon end cap. Power and torque are at the production level. The lasered Acrapovic HP lettering is located on the side surface. With road traffic approval (EU-ABE). Also available as an equipment option.

To be fitted and/or enabled in a specialist workshop, and ideally at your BMW Motorrad dealership.

#### PART NUMBER

**HP sport silencer**  
Order number: 77 11 8 569 434\*

## STORAGE.

### VARIABLE PANNIERS

The variable panniers are fitted with a patented adjustment system. The volume allows their capacity to be reduced from 68l (39l left, 29l right) to 50l (30l left, 20l right). This is particularly useful in city traffic, because the width is reduced by 120mm.

Not available in conjunction with pannier racks.

#### PART NUMBERS

**Variable pannier, left**  
Order number: 77 40 8 569 659\*

**Variable pannier, right**  
Order number: 77 40 8 569 660\*

(+) Repair kit for locking cylinder (one required for each pannier)  
Order number: 77 49 8 404 528\*



1



### VARIABLE TOP BOX AND BACKREST PAD

The watertight variable top box can be secured to the top box holder using the stainless steel luggage grid. As with the variable panniers, the capacity is adjustable, and can be expanded from 25 to 35 litres quickly and easily by moving a bar inside. An optional backrest pad provides increased comfort for the pillion passenger.

Variable top box only in conjunction with top box holder.

2



#### PART NUMBERS

**Variable top box** (image 1)  
Order number: 77 43 8 569 672\*

(+) Repair kit for locking cylinder (one required)  
Order number: 77 49 8 404 528\*

**Backrest pad for variable top box** (image 2)  
Order number: 71 60 7 688 877\*

### PANNIER HOLDERS FOR VARIABLE PANNIERS

These sturdy pannier racks blend in perfectly with the vehicle's overall concept, providing a firm, secure hold for the touring panniers quickly and easily. Also available as an equipment option.

#### PART NUMBERS

**Pannier racks for variable panniers**  
Order number: 77 42 8 405 343\*

(+) Screw M8x30 MK (four required)  
Order number: 07 12 9 908 487\*





**INNER BAGS FOR VARIABLE PANNIER AND VARIABLE TOP BOX**

These practical inner bags make it easier to load and unload the panniers and top box. Just like the panniers and top box, their capacity is adjustable thanks to an all-round zip.

**PART NUMBERS**

**Inner bag for variable pannier, left**

Order number: 77 49 8 536 210\*

**Inner bag for variable pannier, right**

Order number: 77 49 8 534 711\*

**Inner bag for variable top box**

Order number: 77 49 8 534 712\*

**TOP BOX HOLDER FOR VARIABLE TOP BOX**

The robust stainless steel luggage grid with top box holder replaces the standard plastic luggage grid. Also available as an equipment option in conjunction with the pannier holders.

**PART NUMBERS**

**Top box holder for variable top box**

Order number: 46 54 8 404 578\*

(+) Cylinder screw (two required)

Order number: 07 12 9 908 466\*

(+) Cylinder screw (two required)

Order number: 07 12 9 907 381\*



**BAG FOR PILLION SEAT**

This waterproof bag attaches to the pillion seat and offers 2.5l of extra storage expandable to 8l – just the right amount for day trips or even the daily commute. Along with the tankbag, it's the perfect way to add storage space.

**PART NUMBER**

**Bag for pillion seat, 2.5l – 8l**

Order number: 77 45 2 456 667\*



**TANKBAG AND MAP POCKET**

The tankbag is not just an ideal companion on day trips for small luggage. Thanks to the all-round stabilising functional aluminium frame, the optional waterproof DIN A4 map pocket or additional luggage can also be attached to it. An integrated waterproof rain cover keeps everything dry,

**PART NUMBERS**

**Tankbag, 8l – 14l**

Order number: 77 45 2 449 425\*

**Map pocket for tankbag**

Order number: 77 45 2 457 813\*

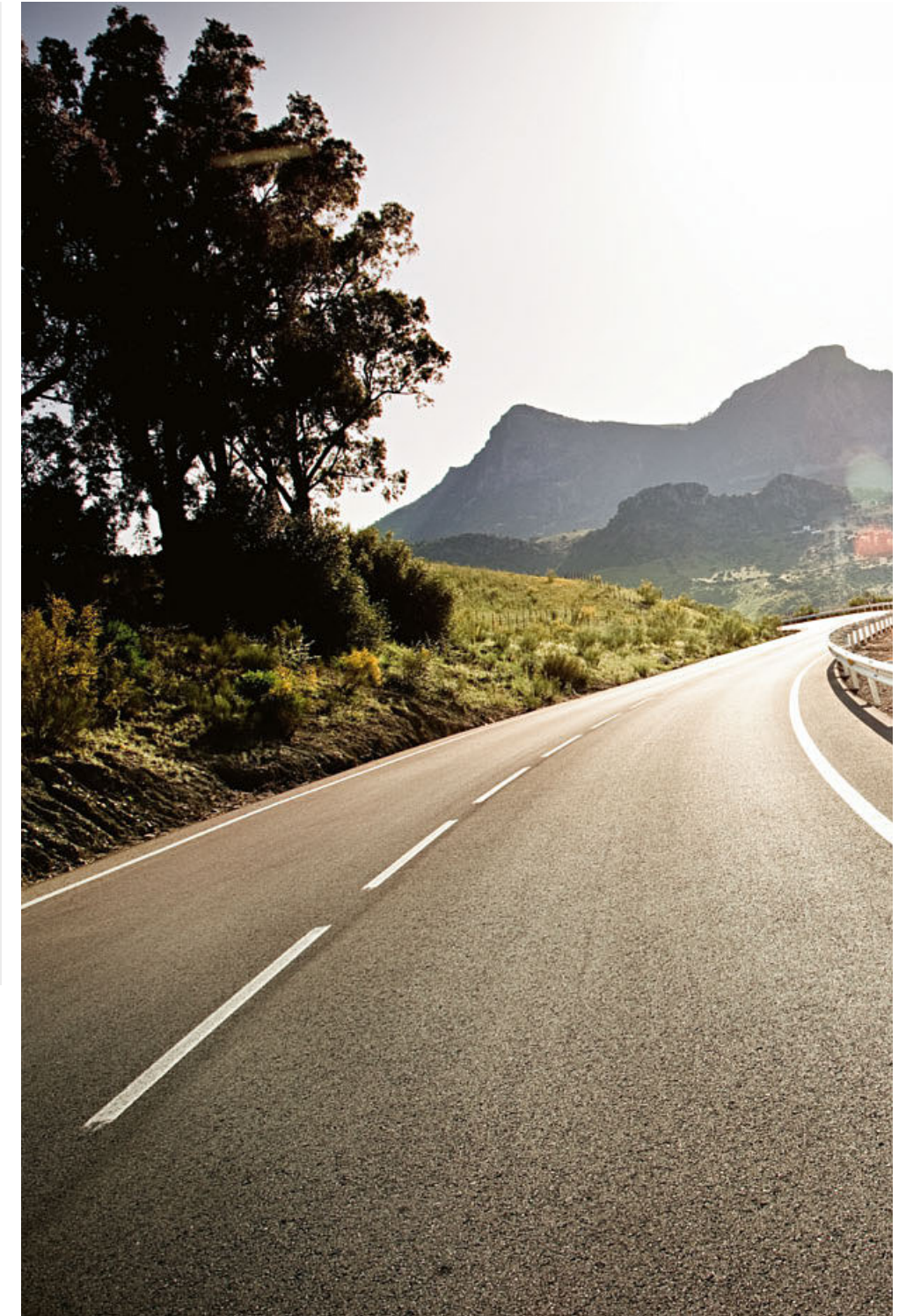

## DESIGN



### LED INDICATORS

The LED indicators complement the design of the BMW F 850 GS perfectly – and thanks to reduced energy consumption and significantly longer bulb life, they're also a shining example of efficiency. Also available as an equipment option.

To be fitted and/or enabled in a specialist workshop, and ideally at your BMW Motorrad dealership.

### PART NUMBERS

**LED indicators, front** (two required)  
Order number: 63 13 8 522 499\*

(+) **LED indicators, rear** (two required)  
Order number: 63 23 8 522 500\*



(+) = "and" – this item must be ordered at the same time  
(o) = "or" – this item may be ordered as an alternative option

## ERGONOMICS & COMFORT



### WINDSHIELDS

The small windshield provides good wind and weather protection while giving the vehicle a sporty look, especially in the tinted option. The tinted version of the large standard windshield underscores the sporty design of the BMW F 850 GS. All windshields come with anti-scratch coating.

To be fitted and/or enabled in a specialist workshop, and ideally at your BMW Motorrad dealership.

### PART NUMBERS

**Small windshield, clear** (image 1)  
Order number: 77 33 8 566 471\*

(o) **Small windshield, tinted** (image 2)  
Order number: 77 33 8 566 472\*

(+) **Windshield holder, low** (not shown)  
Order number: 46 63 8 564 652\* \*

**Large windshield, tinted** (image 3)  
Order number: 77 33 8 566 474\*



### TWO-COLOURED SEATS

The two-tone benches of the BMW F 850 GS are available in standard seat height as well as in the low version for easier boarding and handling. Seat available in low version and as an equipment option.



### PART NUMBERS

**Seat, Black/Red** (not shown)  
(seat height: 860 mm; step length: 1,910 mm)  
Order number: 52 53 8 564 837\*

**Seat, Black/Grey** (not shown)  
(seat height: 860 mm; step length: 1,910 mm)  
Order number: 52 53 8 393 857\*

**Low seat, Black/Red** (image 1)  
(seat height: 835 mm; step length: 1,870 mm)  
Order number: 52 53 8 564 838\*

**Seat, Black/Grey** (image 2)  
(seat height: 835 mm; step length: 1,870 mm)  
Order number: 52 53 8 394 291\*

### HANDLEBARS, HIGH (NOT SHOWN)

The high handlebars are raised by 14 mm and not only enable an upright and comfortable sitting position, but also facilitate safe handling of the motorcycle when driving in a standing position off-road.

To be fitted and/or enabled in a specialist workshop, and ideally at your BMW Motorrad dealership.

### PART NUMBER

**Handlebars, high**  
Order number: 32 71 8 388 531\*

\* Original BMW Motorrad equipment is available from your BMW Motorrad dealer.





### RALLYE SEAT

The narrow width of the Rallye seat keeps the ground within easy reach, making it ideal for off-road riding. It also comes with a raised seat position and firmer padding.

For more detailed information, contact your BMW Motorrad dealership or go online at [bmw-motorrad.com](http://bmw-motorrad.com).

#### PART NUMBER

**Rallye seat**  
(seat height: 890mm; step length: 1,980mm)  
Order number: 77 34 8 564 840\*



### COMFORT SEAT

Climb on and feel at ease. The comfort seat is especially appreciated on longer tours, for both the rider and pillion passenger. Also available as an equipment option.

#### PART NUMBER

**Comfort seat**  
(seat height: 875mm/step length: 1,950mm)  
Order number: 52 53 8 564 839\*



### HEATED GRIPS AND SWITCHES

Warm hands feel good, which is why these heated handlebar grips have two settings designed to keep hands and fingers pleasantly warm. Also available as an equipment option.

To be fitted and/or enabled in a specialist workshop, and ideally at your BMW Motorrad dealership.

#### PART NUMBERS

**Heated grip, left**  
Order number: 61 31 8 552 117\*  
  
(+) Heated grip, right  
Order number: 61 31 8 552 118\*  
  
(+) Multifunction switch, right  
Order number: 61 31 8 394 246\*



### ADJUSTABLE GEAR LEVER

Provides improved control when standing. With adjustable toe piece.

To be fitted and/or enabled in a specialist workshop, and ideally at your BMW Motorrad dealership.

#### PART NUMBER

**Adjustable gear lever**  
Order number: 23 41 8 373 977\*



### ADJUSTABLE FOOTBRAKE LEVER

The wider and height-adjustable foot brake lever has a patented folding mechanism. This makes it easier to reach and the brake pressure can be adjusted more precisely when driving off-road.

To be fitted and/or enabled in a specialist workshop, and ideally at your BMW Motorrad dealership.

#### PART NUMBER

**Adjustable footbrake lever**  
Order number: 35 21 8 569 755\*



### ENDURO FOOT PEGS

On off-road terrain, these wider, longer Enduro foot pegs ensure better control while allowing riders to comfortably use the gear and foot brake levers.

To be fitted and/or enabled in a specialist workshop, and ideally at your BMW Motorrad dealership.

#### PART NUMBERS

**Enduro foot peg, left**  
Order number: 46 71 8 409 497\*  
  
(+) Enduro foot peg, right  
Order number: 46 71 8 409 498\*  
  
(+) Foot peg torsion spring (two required)  
Order number: 46 71 8 526 107\*

### CENTRE STAND (NOT SHOWN)

The sturdy centre stand ensures that the bike remains stable even on loose surfaces. Also available as an equipment option.

Not available in conjunction with No. 499 lowered suspension option.

To be fitted and/or enabled in a specialist workshop, and ideally at your BMW Motorrad dealership.

For more detailed information, contact your BMW Motorrad dealership or go online at [bmw-motorrad.com](http://bmw-motorrad.com)

#### PART NUMBERS

**Centre stand**  
Order number: 46 52 8 358 265\*  
  
(+) Mounting kit  
Order number: 77 25 8 409 390\*  
  
(+) Bumper  
Order number: 46 52 2 332 218\*  
  
(+) Bumper stop (three required)  
Order number: 31 42 8 537 724\*

### PRO GEAR-SHIFT ASSIST (NOT SHOWN)

Delivers smooth shifts up and down without the use of the clutch. Also available as an equipment option.

To be fitted and/or enabled in a specialist workshop, and ideally at your BMW Motorrad dealership.

#### PART NUMBERS

**Pro gear-shift assist**  
Order number: 23 41 8 522 869\*  
  
(+) Enabling code for Pro gear-shift assist  
Order number: 13 61 8 545 879\*

## NAVIGATION AND COMMUNICATION

### BMW MOTORRAD SMARTPHONE CRADLE

Now you can charge your phone out on the road with BMW Motorrad's waterproof smartphone cradle. Charging takes place wirelessly or via a plug-in connection. The display and navigation functions are perfectly positioned in your field of vision and can be easily operated from the cradle. For smartphones with 5" displays or smaller. Max. dimensions: 13.8 cm x 7.3 cm x 1.1 cm. For more detailed information, contact your BMW Motorrad dealership or go online at [bmw-motorrad.com](http://bmw-motorrad.com). Not available in conjunction with preparation for navigation device.



#### PART NUMBERS

##### BMW Motorrad smartphone cradle

Order number: 77 52 8 563 125\*

(+) Smartphone cradle

Order number: 77 52 8 380 735\*

(+) Raised head screw (four required)

Order number: 46 62 7 692 608\*

(+) Washer (four required)

Order number: 07 11 9 904 446\*

(+) Screw (four required)

Order number: 32 71 8 396 665\*

### BMW MOTORRAD NAVIGATION SYSTEMS

Where am I? Where do I want to go, and what's the most scenic way to get there? BMW Motorrad navigation devices show you where to go. Made specifically for motorcyclists, they're easy to fit and use – even with gloves on – and come with lifetime map updates.

The new BMW Motorrad Navigator VI is your ticket to the tour of your dreams. A whole new level of adventure awaits thanks to the "winding roads" route option, "avoid motorways" feature and the "round trip" function, which configures journeys based on time, distance or stopover. The circular polarization filter (CPOL) on the display minimizes reflection and improves contrast, ensuring the screen is easy to read, even in direct sunlight.

16 GB of flash storage, and the ability to stream music from your smartphone, are the ultimate luxury.

For more detailed information, contact your BMW Motorrad dealership or go online at [bmw-motorrad.com](http://bmw-motorrad.com).

BMW Motorrad navigation systems only available in conjunction with optional navigation device preparation.



#### PART NUMBERS

##### BMW Motorrad Navigator VI

Order number: 77 52 8 355 994\*

(o) BMW Motorrad Navigator VI (without map data)

Order number: 77 52 8 356 005\*

(+) = "and" – this item must be ordered at the same time  
(o) = "or" – this item may be ordered as an alternative option

## SAFETY

### HAND PROTECTORS

For effective protection against wind, rain, low branches and flying stones.

To be fitted and/or enabled in a specialist workshop, and ideally at your BMW Motorrad dealership.

Part of the BMW F 850 GS Exclusive and BMW F 850 GS Rallye equipment packages.

#### PART NUMBER

##### Hand protectors

Order number: 77 32 8 358 957\*



### HEADLIGHT GUARD

The headlight guard protects the headlight from damage when riding off-road. It is not approved for road use. Attaches and detaches quickly and easily.

To be fitted and/or enabled in a specialist workshop, and ideally at your BMW Motorrad dealership.

Scheduled availability from third quarter of 2018.

#### PART NUMBER

##### Headlight guard (for off-road use only)

Order number: 77 51 8 356 945\*



### ANTI-THEFT ALARM SYSTEM (NOT SHOWN)

If the motorcycle is moved or struck violently, the system responds with a clearly audible signal and a flashing warning light.

Also available as an equipment option.

To be fitted and/or enabled in a specialist workshop, and ideally at your BMW Motorrad dealership.

#### PART NUMBERS

##### Anti-theft alarm system

Order number: 77 53 8 554 348\*

(+) Lens screw and washer

Order number: 07 14 9 141 517\*

\* Original BMW Motorrad equipment is available from your BMW Motorrad dealer.

### ENGINE PROTECTION BAR

The stainless steel engine protection bar provides effective protection for the motor housing without compromising the lean angle.

For more detailed information, contact your BMW Motorrad dealership or go online at [bmw-motorrad.com](http://bmw-motorrad.com).

To be fitted and/or enabled in a specialist workshop, and ideally at your BMW Motorrad dealership.

Scheduled availability from third quarter of 2018.



#### PART NUMBERS

##### Engine protection bar, left

Order number: 77 41 8 522 927\*

(+) Engine protection bar, right

Order number: 77 41 8 522 928\*

(+) Cylinder screw (three required)

Order number: 07 12 9 908 467\*

(+) Cylinder screw (two required)

Order number: 07 12 9 908 416\*

(+) Cylinder screw

Order number: 07 12 9 908 527\*

(+) Raised head screw

Order number: 46 61 7 713 314\*



### LED AUXILIARY HEADLIGHTS

Increased safety in poor visibility: The LED auxiliary headlights allow you to see and be seen more effectively in fog, snow and rain.

For more detailed information, contact your BMW Motorrad dealership or go online at [bmw-motorrad.com](http://bmw-motorrad.com).

To be fitted and/or enabled in a specialist workshop, and ideally at your BMW Motorrad dealership.

The auxiliary headlights are approved for use as fog lights, and may only be used in poor weather conditions. Country-specific road traffic regulations apply.

### PART NUMBERS

**LED auxiliary headlights** (two required)

Order number: 63 17 8 556 937\*

(+) Bracket for LED auxiliary headlights

Order number: 77 51 8 356 947\*

(+) Bracket for LED auxiliary headlights

Order number: 77 51 8 524 085\*

(+) Additional switch for LED auxiliary headlights

Order number: 61 31 8 533 473\*

(+) Cable harness for LED auxiliary headlights

Order number: 61 12 8 404 348\*

(+) Left bracket

Order number: 32 72 8 565 051\*

(+) Inner Torx screw

Order number: 07 12 9 907 413\*

### ENDURO ALUMINIUM BASH PLATE

This sturdy Enduro aluminium bash plate was specially constructed for off-road use and provides optimal protection for the lower section of the engine.

To be fitted and/or enabled in a specialist workshop, and ideally at your BMW Motorrad dealership.

Scheduled availability from third quarter of 2018.

### PART NUMBER

**Enduro aluminium bash plate**

Order number: 77 14 8 404 511\*

(+) Mounting kit Enduro aluminium bash plate

Order number: 11 84 8 544 599\*



\* Original BMW Motorrad equipment is available from your BMW Motorrad dealer.

## EQUIPMENT FOR THE BMW F 800 GS ADVENTURE.



## STORAGE.



### ALUMINIUM PANNIERS

Together, these sturdy aluminium panniers offer a total capacity of 82l. They have two locks each, plus lashing eyes for securing additional luggage. Central locking is possible.

#### PART NUMBERS

**Aluminium pannier, left**  
Order number: 77 41 8 566 447\*

**Aluminium pannier, right**  
Order number: 77 41 8 566 448\*

(+) Locking cylinders (with codes) for central locking with motorcycle and/or panniers (three required per pannier)  
Order number: 51 25 7 681 199\*

(o) Repair kit for locking cylinder (three required per pannier)  
Order number: 51 25 7 698 202\*

## HP PARTS.



### HP SPORT SILENCER

Made to an exceptional level of craftsmanship, this conical slip-on silencer with dual-flow carbon end cap delivers a powerful rumble, and at 4.1 kg, it's remarkably lightweight.

#### PART NUMBERS

HP sport silencer  
Order number: 77 11 8 567 781\*

### ALUMINIUM TOP BOX AND BACKREST PAD

The waterproof top box has a capacity of 32 litres and lashing eyes for securing additional luggage. And with the optional backrest pad, it provides increased comfort for the pillion passenger.



#### PART NUMBERS

Aluminium top box  
Order number: 77 43 8 566 446\*

(+) Locking cylinders (with codes) for central locking with motorcycle and/or panniers (two required)  
Order number: 51 25 7 681 199\*

(o) Repair kit for locking cylinder (two required)  
Order number: 51 25 7 698 202\*

**Backrest pad for aluminium top box**  
Order number: 71 60 8 546 808\*

### RACK FOR ALUMINIUM TOP BOX

This rack is used to securely fasten the aluminium top box.

#### PART NUMBERS

**Rack for aluminium top box**  
Order number: 71 60 7 696 292\*





### FUNCTIONAL INNER BAG FOR ALUMINIUM PANNIERS

Waterproof inner bags are also available for the aluminium panniers and the top box. The bags are made out of tarpaulin and come with a roll closure system. They are designed to make full use of the capacity of the aluminium panniers and top box, and come with carry handles and a shoulder strap. With the help of the four attached straps, the inner bags can also be attached to the outside of the aluminium panniers and provide additional storage space.

#### PART NUMBERS

**Functional inner bag for aluminium panniers, left**

Order number: 71 60 7 699 055\*

**Functional inner bag for aluminium panniers, right**

Order number: 71 60 7 699 056\*

Functional inner bag for aluminium top box

Order number: 71 60 7 699 057\*

### CARRY HANDLES FOR ALUMINIUM PANNIERS

These practical handles make it easier to carry the aluminium panniers to and from your BMW F 800 GS Adventure. They can also be used to secure additional luggage.

#### PART NUMBERS

**Carry handle for aluminium pannier**

(for a pannier or top box)

Order number: 77 49 8 543 224\*



## DESIGN.

### LED INDICATORS

Cutting-edge design inside and out. The LED indicators complement the design of the BMW F 800 GS Adventure perfectly – and thanks to reduced energy consumption and significantly longer bulb life, they're also a shining example of efficiency. Also available as an equipment option.

To be fitted and/or enabled in a specialist workshop, and ideally at your BMW Motorrad dealership.



#### PART NUMBERS

**LED indicators, front** (two required)

Order number: 63 13 8 522 499\*

(+) Adapters for indicator brackets (two required)

Order number: 63 13 8 535 564\*

(+) Raised head screw (two required)

Order number: 63 12 7 680 859\*

**LED indicators, rear** (two required)

Order number: 63 23 8 522 500\*



### ATACAMA LUGGAGE SYSTEM

Versatile softbag system with various features. Specially made for globetrotters who aren't afraid of tough conditions, with extremely tear-resistant materials and removable watertight inner bags. Thanks to a quick-fastening system, the side bags can be quickly attached to the luggage rack and are just as easy to remove. Backpack-style luggage roll.

Only available in conjunction with pannier mountings for aluminium panniers.



#### PART NUMBERS

**Atacama side bag, 25 and 35 litres**

Order number: 77 40 2 451 375\*

(+) Atacama side bag adapter

Order number: 77 40 2 451 361\*

**Atacama luggage roll, 40 litres**

Order number: 77 40 2 451 381\*

### WATERPROOF TANKBAG

A robust tankbag with a waterproof main compartment, which can be expanded from 12 to 17 l without obstructing the rider's view of the BMW Motorrad Navigator. Its highly water-resistant map pocket has space for one A4 map. For smaller items there are two small, water-resistant exterior pockets.

#### PART NUMBERS

**Waterproof tankbag**

Order number: 77 45 7 726 998\*

(+) = "and" – this item must be ordered at the same time  
(o) = "or" – this item may be ordered as an alternative option



\* Original BMW Motorrad equipment is available from your BMW Motorrad dealer.

## ERGONOMICS AND COMFORT.



### TINTED WINDSHIELD

The tinted version of the standard windshield underlines the powerful yet refined look of the BMW F 800 GS Adventure. With scratch-resistant coating.

#### PART NUMBERS

**Tinted windshield**  
Order number: 77 33 8 559 972\*



### CENTRE STAND

The sturdy centre stand ensures that the bike remains stable even on loose surfaces. Also available as an equipment option.

#### PART NUMBERS

**Centre stand**  
Order number: 46 52 8 528 637\*  
(+) Centre stand attachment  
Order number: 77 25 8 523 119\*

### STANDARD SEAT, TWO-TONE

For more detailed information, contact your BMW Motorrad dealership or go online at [bmw-motorrad.com](http://bmw-motorrad.com).

#### PART NUMBERS

**Seat, Black/Red** (image 1)  
(seat height: 890 mm; step length: 1,960 mm)  
Order number: 52 53 8 560 377\*  
**Seat, Black/Stone Grey** (image 2)  
(seat height: 890 mm; step length: 1,960 mm)  
Order number: 52 53 8 561 694\*



### LOW SEAT, BLACK

The 860-mm seat height makes climbing on and handling easier.

Also available as an equipment option. For more detailed information, contact your BMW Motorrad dealership or go online at [bmw-motorrad.com](http://bmw-motorrad.com).

#### PART NUMBERS

**Low seat, Black**  
(seat height: 860 mm; step length: 1,920 mm)  
Order number: 52 53 8 535 834\*

### HEATED GRIPS AND SWITCHES (NOT SHOWN)

Warm hands feel good, which is why these heated handlebar grips have two settings designed to keep hands and fingers pleasantly warm. Also available as an equipment option.

For more detailed information, contact your BMW Motorrad dealership or go online at [bmw-motorrad.com](http://bmw-motorrad.com). To be fitted and/or enabled in a specialist workshop, and ideally at your BMW Motorrad dealership.



## NAVIGATION AND COMMUNICATION



### BMW MOTORRAD NAVIGATION SYSTEMS

Where am I? Where do I want to go, and what's the most scenic way to get there? BMW Motorrad navigation devices show you where to go. Made specifically for motorcyclists, they're easy to fit and use – even with gloves on – and come with lifetime map updates.

The new BMW Motorrad Navigator VI is your ticket to the tour of your dreams. A whole new level of adventure awaits thanks to the "winding roads" route option, "avoid motorways" feature and the "round trip" function, which configures journeys based on time, distance or stopover. The circular polarization filter (CPOL) on the display minimizes reflection and improves contrast, ensuring the screen is easy to read, even in direct sunlight.

16 GB of flash storage, and the ability to stream music from your smartphone, are the ultimate luxury.

Thanks to Bluetooth® technology, the sophisticated BMW Motorrad Navigator Street (with easy-to-read 4.3" display) is compatible with the optional BMW Motorrad communication system and comes with a host of handy features.

For more detailed information, contact your BMW Motorrad dealership or go online at [bmw-motorrad.com](http://bmw-motorrad.com).

BMW Motorrad navigation devices and the BMW Motorrad smartphone cradle can only be mounted using the BMW Motorrad navigation device bracket.

#### PART NUMBERS

**BMW Motorrad Navigator VI with cradle mount** (image 1)

Order number: 77 52 8 355 749\*

(o) **BMW Motorrad Navigator VI** (without map data)

Order number: 77 52 8 356 005\*

(+) 4-button cradle mount

Order number: 77 52 8 544 464\*

(+) 4-button cradle mount

Order number: 77 52 8 544 464\*

**BMW Motorrad Navigator Street** (image 3)

Order number: 77 52 8 557 855\*

**Bracket clamp for BMW Motorrad navigation devices**

Order number: 71 60 7 713 903\*

(+) Navigation adapter cable

Order number: 61 12 8 544 442\*

### BMW MOTORRAD SMARTPHONE CRADLE

Now you can charge your phone out on the road with BMW Motorrad's waterproof smartphone cradle. Charging takes place wirelessly or via a plug-in connection. The display and navigation functions are perfectly positioned in your field of vision and can be easily operated from the cradle. For smartphones with 5" displays or smaller. Max. dimensions: 13.8 cm x 7.3 cm x 1.1 cm.

For more detailed information, contact your BMW Motorrad dealership or go online at [bmw-motorrad.com](http://bmw-motorrad.com).

Only in combination with bracket for BMW Motorrad navigation devices.

#### PART NUMBERS

**BMW Motorrad smartphone cradle**

Order number: 77 52 8 563 125\*



(+) = "and" – this item must be ordered at the same time

(o) = "or" – this item may be ordered as an alternative option

## SAFETY.

### ASC (AUTOMATIC STABILITY CONTROL), SWITCHABLE (NOT SHOWN)

Controls and optimizes transmission and prevents rear wheel spin – on wet surfaces, for example. Also available as an equipment option.

For more detailed information, contact your BMW Motorrad dealership or go online at [bmw-motorrad.com](http://bmw-motorrad.com).

To be fitted and/or enabled in a specialist workshop, and ideally at your BMW Motorrad dealership.

#### PART NUMBERS

ASC (Automatic Stability Control), switchable

### ANTI-THEFT ALARM SYSTEM WITH REMOTE CONTROL

If the motorcycle is moved or struck violently, the system responds with a clearly audible signal and a flashing warning light. Easy to operate remotely. Also available as an equipment option.

To be fitted and/or enabled in a specialist workshop, and ideally at your BMW Motorrad dealership.

Mounting instructions are available from your BMW Motorrad dealership.

#### PART NUMBERS

**Anti-theft alarm system with remote control**

Order number: 77 53 8 545 003\*

(+) Bracket

Order number: 65 75 7 707 271\*

(+) Grommet (four required)

Order number: 62 21 7 670 749\*

(+) Resistor

Order number: 61 13 7 668 405\*



### LED AUXILIARY HEADLIGHTS

The LED auxiliary headlights deliver increased safety when visibility is poor, e.g. in fog, snow and rain.

For more detailed information, contact your BMW Motorrad dealership or go online at [bmw-motorrad.com](http://bmw-motorrad.com).

To be fitted and/or enabled in a specialist workshop, and ideally at your BMW Motorrad dealership.

The auxiliary headlights are approved for use as fog lights, and may only be used in poor weather conditions. Country-specific road traffic regulations apply.

#### PART NUMBERS

**LED auxiliary headlights** (two required)

Order number: 63 17 8 556 937\*

(+) Set of brackets for auxiliary headlights (one required)

Order number: 77 51 8 530 686\*

(+) Cable harness for LED auxiliary headlights

Order number: 61 12 8 356 909\*

(+) Multifunction switch

(+) Cable tie (six required)

Order number: 61 13 1 367 599\*



### ENDURO ALUMINIUM BASH PLATE

This Enduro aluminium bash plate was specially constructed for off-road use and provides optimal protection for the lower section of the engine.

For more detailed information, contact your BMW Motorrad dealership or go online at [bmw-motorrad.com](http://bmw-motorrad.com).

Model shown: BMW F 800 GS, 2017.

#### PART NUMBERS

**Enduro aluminium bash plate**

Order number: 71 60 7 702 951\*

(+) Mounting parts

Order number: 71 60 8 526 643\*

\* Original BMW Motorrad equipment is available from your BMW Motorrad dealer.

## EQUIPMENT FOR THE BMW S 1000 XR.



## HP PARTS.

### HP SPORT SILENCER

A top-class feature for top-quality sound: made entirely of titanium, with a carbon end cap and heat shield, plus a laser-etched logo. The HP sport silencer turns every ride into a thrilling experience. Approx. 1.5 kg lighter than the standard silencer. Mounting instructions are available from your BMW Motorrad dealership.

#### PART NUMBER

**HP sport silencer**  
Order number: 77 11 8 393 918\*



### HP AXLE PROTECTORS

These highly abrasion-resistant plastic drop-protection pads for the front axle protect the front fork from damage. Mounting instructions are available from your BMW Motorrad dealership.

#### PART NUMBER

**HP axle protectors, front**  
Order number: 77 25 8 546 532\*



### HP FOOT PEGS FOR RIDER AND PILLION PASSENGER

These CNC-milled HP foot pegs for rider and pillion, with clutch lever and brake lever, combine aesthetic appeal with exceptional functionality. A wide range of adjustment options offer riders everything they need when it comes to ergonomics and track-style riding. Pillion rider foot pegs are available in an identical style. To be fitted and/or enabled in a specialist workshop, and ideally at your BMW Motorrad dealership.

#### PART NUMBERS

**HP rider foot peg, left** (image 1)  
Order number: 77 25 8 553 929\*  
(+) **HP rider foot peg, right** (image 2)  
Order number: 77 25 8 553 930\*  
**HP pillion passenger foot peg, left** (image 3)  
Order number: 77 25 8 554 325\*  
(+) **HP pillion passenger foot peg, right**  
Order number: 77 25 8 554 326\*



### PRO GEAR-SHIFT ASSIST

Delivers smooth shifts without the use of the clutch. Also available as an equipment option. To be fitted and/or enabled in a specialist workshop, and ideally at your BMW Motorrad dealership.

#### PART NUMBERS

**Pro gear-shift assist**  
Order number: 23 41 8 553 660\*  
(+) **Enabling code for Pro gear-shift assist**  
Order number: 13 61 8 545 879\*  
(+) **Adapter cable**  
Order number: 61 12 8 545 380\*  
(+) **Cable duct**  
Order number: 61 13 8 554 008\*  
(+) **Torx screw M5x10**  
Order number: 07 12 9 907 433\*

### HP MILLED BRAKE AND CLUTCH LEVERS

Made out of corrosion-resistant, anodized aluminium, the newly developed CNC-milled HP brake and clutch levers can be adjusted to provide the most suitable position for every rider (brake lever 5 positions, clutch lever 3 positions). To be fitted and/or enabled in a specialist workshop, and ideally at your BMW Motorrad dealership.

#### PART NUMBERS

**HP milled clutch lever** (image 1)  
Order number: 77 22 8 355 201\*  
(+) **HP milled brake lever** (image 2)  
Order number: 77 22 8 355 202\*







### HP CARBON BOLT-ON PARTS

Superlative performance is a given with these bolt-on parts. They're elegant, exclusive and durable – each one a masterpiece in its own right. And if perfection's what you're after, you've hit the jackpot here because they're made of carbon, the ultimate lightweight material. An unbeatable combination of stylish looks and technical expertise.

#### Small mounting parts included.

For more detailed information, contact your BMW Motorrad dealership or go online at [bmw-motorrad.com](http://bmw-motorrad.com).

#### PART NUMBERS

- HP carbon mudguard, front** (image 1)  
Order number: 77 31 8 549 539\*
- HP carbon mudguard, rear** (image 2)  
Order number: 77 31 8 551 910\*
- HP carbon cockpit cladding, left** (image 3)  
Order number: 77 31 8 551 919\*  
(+) HP carbon cockpit cladding, right  
Order number: 77 31 8 551 920\*
- HP carbon fuel filler cap** (image 4)  
Order number: 77 31 8 551 921\*
- HP carbon sprocket cover** (image 5)  
Order number: 77 31 8 555 880\*
- HP carbon trim for number-plate holder** (image 6)  
Order number: 77 31 8 551 922\*

### HP ENGINE PROTECTORS

Aluminium engine protectors with plastic sliders provide additional protection for your engine.

To be fitted and/or enabled in a specialist workshop, and ideally at your BMW Motorrad dealership.

Not available in conjunction with engine protection bar.

#### PART NUMBERS

- HP engine protector, left**  
Order number: 77 25 8 545 293\*
- (+) HP engine protector, right  
Order number: 77 25 8 545 292\*

### HP FORGED WHEELS

The forged, black-anodized HP aluminium wheels deliver improved responses and a significant weight reduction (2 kg less than standard wheels). To be fitted and/or enabled in a specialist workshop, and ideally at your BMW Motorrad dealership.

#### PART NUMBERS

- HP forged wheel, front**  
Order number: 77 21 8 555 035\*
- (+) Brake disc (two required)  
Order number: 34 11 8 523 478\*
- (+) Adapter for sensors  
Order number: 77 21 8 555 041\*
- (+) Sensor ring T=48  
Order number: 34 52 8 523 479\*
- (+) ISA screw M5x6 (six required)  
Order number: 07 12 9 907 842\*
- (+) Screw lock  
Order number: 83 19 2 210 339\*
- (+) Cylinder screw M8x25 (12 required)  
Order number: 07 12 9 907 382\*
- (+) Inner TORX screw M5x12 (two required)  
Order number: 07 12 9 907 413\*
- (+) Cylinder screw M6x16  
Order number: 07 12 9 908 404\*

#### HP forged wheel, rear

Order number: 77 21 8 555 036\*

- (+) Spacing bushing  
Order number: 36 31 8 534 822\*
- (+) Camshaft sprocket carrier  
Order number: 33 81 8 530 679\*
- (+) Damper (five required)  
Order number: 33 81 8 530 682\*
- (+) Camshaft sprocket T=45  
Order number: 33 81 8 532 146\*
- (+) Fitting screw M12x1.5 (five required)  
Order number: 33 81 8 532 733\*
- (+) Flange nut (five required)  
Order number: 27 71 7 724 142\*



### HP CHAIN TENSIONER

The HP chain tensioner offers high-precision adjustment of chain tension and rear-wheel alignment. It's securely attached to the swing arm, which makes it easier to fit the rear wheel.

#### PART NUMBER

- HP chain tensioner**  
Order number: 77 25 8 560 292\*

# STORAGE



## TOURING PANNIERS

These sturdy, splash-proof panniers with lid paintwork in bike colour blend in perfectly with the vehicle's overall design. Each pannier offers a capacity of 31 litres and can carry a 10 kg load. There is plenty of space for a helmet on either side, and the design makes loading and unloading even easier.

### PART NUMBERS

**Touring pannier, left, Granite Grey Matt Metallic (image 1)**

Order number: 77 41 8 554 545\*

**(o) Touring pannier, left, Racing Red (image 2)**

Order number: 77 41 8 556 479\*

**(+)** Touring pannier, right, Granite Grey Matt Metallic

Order number: 77 41 8 554 546\*

**(o)** Touring pannier, right, Racing Red

Order number: 77 41 8 556 480\*

**(+)** Mounting parts for single pannier (two required)

Order number: 71 60 7 680 840\*

**(+)** Locking cylinder (with codes) for central locking with motorcycle (two required)

Order number: 51 25 7 681 200\*

**(o)** Repair kit for locking cylinder (two required)

Order number: 51 25 7 698 204\*

## SMALL TOP BOX AND BACKREST PAD

The waterproof top box has a capacity of 30l and a maximum load of 5 kg – perfect for a helmet, for example. The lid has the same paintwork as the touring pannier and is equipped with a soft-close mechanism. A backrest pad and central locking functionality are also available upon request.

### PART NUMBERS

**Small top box, 30l**

Order number: 77 43 8 543 246\*

**Small mounting parts included.**

For more detailed information, contact your BMW Motorrad dealership or go online at [bmw-motorrad.com](http://bmw-motorrad.com).

**(+)** Top box lid outer shell in Granite Grey Matt Metallic

Order number: 77 43 8 553 127\*

**(o)** Top box lid outer shell in Racing Red

Order number: 77 43 8 555 607\*

**(+)** Locking cylinder (with codes) for central locking with motorcycle

Order number: 51 25 7 681 200\*

**(o)** Repair kit for locking cylinder

Order number: 51 25 7 698 204\*

**Backrest pad for small top box**

Order number: 77 44 8 549 334\*

(+) = "and" – this item must be ordered at the same time

(o) = "or" – this item may be ordered as an alternative option



## PANNIER RACK

These sturdy pannier racks blend in perfectly with the vehicle's overall design – even when the panniers have been removed – and firmly secure the touring panniers, quickly and easily. Also available as an equipment option.

### PART NUMBERS

**Pannier rack, left**

Order number: 46 54 8 548 739\*

**(+)** Pannier rack, right

Order number: 46 54 8 548 740\*

**(+)** Cross pipe

Order number: 46 54 8 536 085\*

**(+)** Cover for pannier rack, right

Order number: 46 54 8 548 746\*

**(+)** Cover for pannier rack, left

Order number: 46 54 8 548 746\*

**(+)** ISA screw M8x16 (two required)

Order number: 07 12 9 907 384\*

**(+)** ISA screw M6x70 (two required)

Order number: 07 12 9 907 375\*

**(+)** ISA screw M8x65 (two required)

Order number: 07 12 9 907 295\*

**(+)** Cylinder screw M8x40 (two required)

Order number: 07 12 9 907 379\*

**(+)** Bolts (two required)

Order number: 46 54 8 555 516\*



## INNER BAG FOR SMALL TOP BOX

Makes loading and unloading a top box even easier. The inner bag comes with a practical carry handle and can be folded flat when not in use.

### PART NUMBERS

**Inner bag for small top box**

Order number: 77 43 8 549 130\*

## INNER BAGS FOR TOURING PANNIERS

These practical, water-resistant inner bags make full use of the capacity of the touring panniers. Luggage can be accessed easily with one hand, and the bag can even be worn over the shoulder thanks to a detachable strap.

### PART NUMBERS

**Inner bag for touring pannier, left**

Order number: 77 41 8 556 290\*

**Inner bag for touring pannier, right**

Order number: 77 41 8 555 955



## LARGE TOP BOX AND BACKREST PAD

At 49 litres, the waterproof top box has a painted lid and offers plenty of space, for example for two helmets. The optional backrest pad offers additional comfort for the pillion passenger.

To be fitted and/or enabled in a specialist workshop, and ideally at your BMW Motorrad dealership.

### PART NUMBERS

**Large top box, 49l**

Order number: 77 43 8 551 996\*

**(+)** Top box lid outer shell in Granite Grey Matt Metallic

Order number: 77 43 8 354 934\*

**(o)** Top box lid outer shell in Racing Red

Order number: 77 43 8 354 935\*

**(+)** Locking cylinder (with codes) for central locking with motorcycle

Order number: 51 25 7 681 200\*

**(o)** Repair kit for locking cylinder

Order number: 51 25 7 698 204\*

**(+)** Badge

Order number: 51 14 8 164 924\*

**(O)** Thread cutting screw K40x12

Order number: 07 14 7 698 893\*

**Backrest pad for top box, large**

Order number: 77 44 8 561 434\*



## INNER BAG FOR LARGE TOP BOX

This user-friendly inner bag has a large main compartment and two outer pockets, making full use of the top box's capacity and folding flat when not in use. Loading and unloading can be accomplished quickly and easily.

### PART NUMBERS

**Inner bag for large top box**

Order number: 77 43 8 549 124\*

**TANKBAG AND MAP POCKET FOR TANKBAG**

The tankbag sits snugly on the tank without obstructing the rider's view of the BMW Motorrad Navigator. The lockable main compartment is waterproof, and can be expanded from 10 to 15l. And there's also a small, water-resistant exterior pocket for easy access to small items. With carry handle. A waterproof A4 map pocket is also available. It can be attached easily and securely with magnetic catches.



**PART NUMBERS**

**Tankbag** (image 1)  
Order number: 77 49 8 551 736\*

**Waterproof map pocket for tankbag** (image 2)  
Order number: 77 45 8 561 547\*

**LUGGAGE GRID AND TOP BOX HOLDER**

This secure base for the small top box blends in perfectly with the vehicle's overall design and replaces the standard pillion passenger grab handles. Also available as an equipment option.

**Small mounting parts are not included.**

For more detailed information, contact your BMW Motorrad dealership or go online at [bmw-motorrad.com](http://bmw-motorrad.com).

**PART NUMBERS**

**Luggage grid**  
Order number: 46 54 8 567 908\*

(+) Top box rack  
Order number: 46 54 7 717 019\*



(+) = "and" – this item must be ordered at the same time  
(o) = "or" – this item may be ordered as an alternative option

**DESIGN**



**LED INDICATORS**

Cutting-edge design inside and out. The LED indicators complement the design of the BMW S 1000 XR perfectly – and thanks to reduced energy consumption and significantly longer bulb life, they're also a shining example of efficiency. Also available as an equipment option.

To be fitted and/or enabled in a specialist workshop, and ideally at your BMW Motorrad dealership.

**PART NUMBER**

**LED indicators** (four required)  
Order number: 63 13 8 522 499\*

\* Original BMW Motorrad equipment is available from your BMW Motorrad dealer.

## ERGONOMICS AND COMFORT



### TINTED WINDSHIELD

The tinted version of the standard windshield underlines the powerful yet refined look of the BMW S 1000 XR. With scratch-resistant coating. To be fitted and/or enabled in a specialist workshop, and ideally at your BMW Motorrad dealership.

#### PART NUMBER

**Tinted windshield**  
Order number: 77 33 8 551 929\*



### CRUISE CONTROL

Also available as an equipment option. To be fitted and/or enabled in a specialist workshop, and ideally at your BMW Motorrad dealership. For more detailed information, contact your BMW Motorrad dealership or go online at [bmw-motorrad.com](http://bmw-motorrad.com).



### CENTRE STAND

The sturdy centre stand ensures that the bike remains stable even on loose surfaces. Also available as an equipment option. To be fitted and/or enabled in a specialist workshop, and ideally at your BMW Motorrad dealership.

#### PART NUMBERS

##### Centre stand

Order number: 46 52 7 723 848\*  
Not available in conjunction with the lowered suspension option.

(o) Centre stand for lowered suspension  
Order number: 46 52 7 723 847\*  
Not available in conjunction with the lowered suspension option.

(+) Centre stand mounting parts  
Order number: 77 25 8 553 922\*

### HEATED GRIPS

Warm hands feel good, which is why these heated handlebar grips have two settings designed to keep hands and fingers pleasantly warm. Also available as an equipment option. To be fitted and/or enabled in a specialist workshop, and ideally at your BMW Motorrad dealership.

For more detailed information, contact your BMW Motorrad dealership or go online at [bmw-motorrad.com](http://bmw-motorrad.com).



### SEATS

All seats are available in two heights, for the perfect knee angle. Specially developed for the BMW S 1000 XR and finished to the highest standards, the padded HP sport seat offers increased comfort on longer journeys.



#### PART NUMBERS

**HP Sport high seat** (image 1)  
(seat height: 855 mm; step length: 1,925 mm)  
Order number: 77 34 7 717 180\*

**HP Sport seat** (image 2)  
(seat height: 840 mm; step length: 1,894 mm)  
Order number: 77 34 8 549 529\*

**Seat** (image 3)  
(seat height: 840 mm; step length: 1,894 mm)  
Order number: 52 53 7 717 179\*

**Low seat** (also available as an equipment option) (image 4)  
(seat height: 820 mm; step length: 1,860 mm)  
Order number: 52 53 7 717 178\*

(+) = "and" – this item must be ordered at the same time  
(o) = "or" – this item may be ordered as an alternative option



\* Original BMW Motorrad equipment is available from your BMW Motorrad dealer.

## NAVIGATION AND COMMUNICATION



### BMW MOTORRAD NAVIGATION SYSTEMS

Where am I? Where do I want to go, and what's the most scenic way to get there? BMW Motorrad navigation devices show you where to go. Made specifically for motorcyclists, they're easy to fit and use – even with gloves on – and come with lifetime map updates.

The new BMW Motorrad Navigator VI is your ticket to the tour of your dreams. A whole new level of adventure awaits thanks to the "winding roads" route option, "avoid motorways" feature and the "round trip" function, which configures journeys based on time, distance or stopover. The circular polarization filter (CPOL) on the display minimizes reflection and improves contrast, ensuring the screen is easy to read, even in direct sunlight. 16 GB of flash storage, and the ability to stream music from your smartphone, are the ultimate luxury.

For more detailed information, contact your BMW Motorrad dealership or go online at [bmw-motorrad.com](http://bmw-motorrad.com).

#### PART NUMBERS

**BMW Motorrad Navigator VI**  
(with map data for Europe) (top image)  
Order number: 77 52 8 355 994

(o) BMW Motorrad Navigator VI (without map data)  
Order number: 77 52 8 356 005\*

## SAFETY

### ENGINE PROTECTION BAR

The stainless steel, electropolished engine protection bars provide effective protection for the sides of the engine, without compromising the lean angle. To be fitted and/or enabled in a specialist workshop, and ideally at your BMW Motorrad dealership.

Not available in conjunction with engine protectors

**Small mounting parts are not included.**

For more detailed information, contact your BMW Motorrad dealership or go online at [bmw-motorrad.com](http://bmw-motorrad.com).



#### PART NUMBERS

**Engine protection bar, left**  
Order number: 77 14 8 548 831\*

(+) Engine protection bar, right  
Order number: 77 14 8 548 832\*

### HAND PROTECTORS

This tough hand protector is made of shatter-proof, UV-resistant plastic and provides effective protection for the hands against low branches and flying stones. Also available as an equipment option.

#### PART NUMBER

**Hand protectors**  
Order number: 77 32 8 553 967\*



### ANTI-THEFT ALARM SYSTEM (NOT SHOWN)

If the motorcycle is moved or struck violently, the system responds with a clearly audible signal and a flashing warning light. Also available as an equipment option. To be fitted and/or enabled in a specialist workshop, and ideally at your BMW Motorrad dealership.

#### PART NUMBERS

**Anti-theft alarm system (DWA)**  
Order number: 77 53 8 554 348\*

(+) 10 Ah battery  
Order number: 61 21 8 544 472\*

(+) Raised head screw (three required)  
Order number: 07 14 9 141 517\*

### ABS PRO ENABLING CODE (NOT SHOWN)

The BMW Motorrad ABS Pro is available in all riding modes and also adapts the ABS control to the motorcycle's lean angle. The system is perfectly adapted to the selected riding mode and ensures optimum braking performance even in bends. The motorcycle does not right itself and remains on course.

#### PART NUMBERS

**ABS Pro enabling code**  
Order number: 77 23 8 546 512\*

(+) Rate sensor  
Order number: 61 35 8 546 524\*

(+) Pro riding modes enabling code  
Order number: 13 61 8 534 237\*

(+) Enabling code for DTC  
Order number: 13 61 8 550 119\*

(+) ISA screw M6x20  
Order number: 07 12 9 907 402\*

## EQUIPMENT FOR THE BMW R 1200 GS.



## HP PARTS.

### HP SPORT SILENCER

Exclusively designed for BMW Motorrad, this all-titanium slip-on silencer weighs only 4.3 kilogrammes, and gives a full-bodied sound and increased torque at low and medium revs. Mounting instructions are available from your BMW Motorrad dealership.

#### PART NUMBER

**HP sport silencer**  
Order number: 77 11 8 569 593\*



### HP MILLED BRAKE AND CLUTCH LEVERS

Made from corrosion-resistant anodized aluminium, the CNC-milled HP brake and clutch levers have individually adjustable reaches: five steps in the case of the brake lever, and three for the clutch. To be fitted and/or enabled in a specialist workshop, and ideally at your BMW Motorrad dealership.

#### PART NUMBERS

**HP milled clutch lever**  
Order number: 77 25 8 554 323\*  
(+) HP milled brake lever  
Order number: 77 25 8 554 324\*



## STORAGE



### INNER BAGS FOR ALUMINIUM PANNIERS AND TOP BOX

Waterproof inner bags are also available for the aluminium panniers and the top box. They make loading and unloading easier, protect luggage, and come with straps that make them easy to transport. The inner bags can also be attached to the outside of the aluminium panniers using the four enclosed straps, and they provide additional storage space.

#### PART NUMBERS

**Inner bag for aluminium pannier, left**  
Order number: 77 41 8 543 197\*  
**Inner bag for aluminium pannier, right**  
Order number: 77 41 8 543 199\*  
**Inner bag for aluminium top box**  
Order number: 77 43 8 543 194\*



### RACK FOR ALUMINIUM TOP BOX

#### PART NUMBERS

**Top box rack for aluminium top box** (image 1)  
Order number: 46 54 8 522 360  
**Black top box rack for aluminium top box** (image 2)  
Order number: 77 41 2 455 701  
**For both colour variants**  
(+) Cylinder screw M8x40 (two required)  
Order number: 07 12 9 908 466\*  
(+) Cylinder screw M8x25 (two required)  
Order number: 07 12 9 908 467\*  
(+) Bushing (two required)  
Order number: 46 54 8 540 993\*



### ALUMINIUM TOP BOX, 32L

The waterproof top box has a capacity of 32 litres and lashing eyes for securing additional luggage. And with the optional backrest pad added, it provides increased comfort for the pillion passenger.

#### PART NUMBERS

**Aluminium top box, 32 l** (image 1)  
Order number: 77 43 8 562 407  
**Black aluminium top box, 32 l** (image 2)  
Order number: 77 43 2 455 447\*  
**For both colour variants**  
(+) Locking cylinder (with codes) for top box for central locking with motorcycle  
Order number: 77 49 8 544 513\*  
(o) Repair kit for locking cylinder (two required)  
Order number: 77 49 8 544 517\*  
**Backrest pad for aluminium top box**  
Order number: 77 44 8 546 808\*



### ALUMINIUM PANNIERS

Together, these robust panniers offer a total capacity of 80 litres. They have two locks each, plus lashing eyes for additional luggage. Motorcycle central locking possible.

#### PART NUMBERS

**Aluminium pannier, left, 44l** (image 1)  
Order number: 77 41 8 562 409

**Aluminium pannier, right, 36l**  
Order number: 77 41 8 562 410

**Black aluminium pannier, left, 44l**  
Order number: 77 41 2 455 445

**Black aluminium pannier, right, 36l** (image 2)  
Order number: 77 41 2 455 446

**(+) Pannier rack, left** (image 3)  
46 54 8 520 067

**(+) Pannier rack, right** (image 3)  
46 54 8 520 068

**Pannier rack, rear cross brace** (image 3)  
46 54 8 520 069

**Black pannier rack, left**  
Order number: 77 41 2 455 698\*

**(+) Black pannier rack, right**  
Order number: 77 41 2 455 699

**(+) Black pannier rack, rear cross brace**  
Order number: 77 41 2 455 700

(+) 77 43 8 543 993 mounting kit



### CARRY HANDLES FOR ALUMINIUM LUGGAGE SYSTEM

These practical handles make it easier to carry the aluminium panniers to and from your bike. They can also be used to secure additional luggage.

#### PART NUMBER

**Carry handle for aluminium panniers and top box**  
Order number: 77 49 8 543 224\*



### INNER BAG FOR LARGE TOP BOX, 49L

This user-friendly inner bag has a large main compartment and two outer pockets, making full use of the top box's capacity and folding flat when not in use. Loading and unloading can be accomplished quickly and easily.

#### PART NUMBER

**Inner bag for large top box, 49l**  
Order number: 77 43 8 549 124\*



### ATACAMA LUGGAGE SYSTEM

Versatile softbag system with various features. Specially made for globetrotters who aren't afraid of tough conditions, with extremely tear-resistant materials and removable watertight inner bags. Thanks to a quick-fastening system, the side bags can be quickly attached to the luggage rack and are just as easy to remove. Backpack-style luggage roll.

Only available in conjunction with pannier racks for aluminium panniers.

#### PART NUMBERS

**Atacama side bag, 25 and 35 litres**  
Order number: 77 40 2 451 375\*

**(+) Atacama side bag adapter**  
Order number: 77 40 2 451 360\*

**Atacama luggage roll, 40 litres**  
Order number: 77 40 2 451 381\*



### VARIABLE PANNIERS

The variable panniers are fitted with a patented adjustment system, allowing the capacity to be reduced from 68 litres (29 left, 39 right) to 50 litres (20 left, 30 right). This is particularly useful in city traffic, because the width is reduced by 120mm.

#### PART NUMBERS

**Variable pannier, left, 30-39 litres**  
Order number: 77 40 7 721 035\*

**Variable pannier, right, 20-29 litres**  
Order number: 77 41 8 567 204\*

**(+) Pannier rack for black variable panniers**  
Order number: 77 42 2 459 692

**(o) Pannier rack for black variable panniers**  
Order number: 77 42 8 525 874

Mounting instructions are available from your BMW Motorrad dealership.

**(+) Locking cylinder for two panniers**  
Order number: 51 25 7 688 566\*

**(o) Locking cylinder for two panniers and top box**  
Order number: 51 25 7 688 567\*

**(o) Locking cylinder (with codes) for central locking with motorcycle (one required per pannier)**  
Order number: 51 25 7 681 199\*

**(o) Repair kit for locking cylinder (one required per pannier)**  
Order number: 51 25 7 698 202\*



### INNER BAGS FOR VARIABLE PANNIER AND TOP BOX

These practical inner bags make it easier to load and unload the panniers and top box. Just like the panniers and top box, their capacity is adjustable thanks to an all-round zip.

#### PART NUMBERS

**Inner bag for variable pannier, left**  
Order number: 77 49 8 536 210\*

**Inner bag for variable pannier, right**  
Order number: 77 49 8 534 711\*

**Inner bag for variable top box**  
Order number: 77 49 8 534 712\*



### VARIABLE TOP BOX AND BACKREST PAD

The waterproof variable top box can be mounted onto the standard luggage grid using the adapter plate. Alternatively, it can be fitted in conjunction with the optional luggage grid to replace the pillion passenger seat. As with the variable panniers, the capacity is adjustable, and can be expanded from 25 to 35 litres quickly and easily by moving a bar inside. An optional backrest pad provides increased comfort for the pillion passenger.

#### PART NUMBERS

**Variable top box**  
Order number: 77 40 7 721 037\*

**(+) Top box holder for luggage grid**  
Order number: 77 44 8 523 743\*

**(+) Locking cylinder (with codes) for central locking with motorcycle**  
Order number: 51 25 7 681 199\*

**(o) Repair kit for locking cylinder**  
Order number: 51 25 7 698 202\*

**Backrest pad for variable top box**  
Order number: 71 60 7 688 877\*

#### PART NUMBERS

**Luggage grid for pillion seat**  
Order number: 77 44 8 523 742\*

**(+) Covers for holes for grab handles**  
Order number: 77 30 8 546 226\*



**LARGE TOP BOX, 49L AND BACKREST PAD**

At 49 litres, the waterproof top box has a painted lid and offers plenty of space, for example for two helmets. The optional backrest pad offers additional comfort for the pillion passenger.

To be fitted and/or enabled in a specialist workshop, and ideally at your BMW Motorrad dealership.



**SMALL TANKBAG**

The lockable main compartment of the small tankbag holds 8l and is waterproof. The water-repellent exterior pocket safely holds a 0.5-litre PET bottle. The map pocket is also water repellent.

**PART NUMBER**

**Small tankbag, 8l**  
Order number: 77 45 8 559 153\*



**LARGE TANKBAG**

The capacity of the lockable, waterproof main compartment can be expanded from 11 to 15 litres. The water-repellent exterior pocket safely holds a 0.5-litre PET bottle. The map pocket is also water repellent.

**PART NUMBER**

**Large tankbag, 11-15 litres**  
Order number: 77 45 8 559 154\*



**LED INDICATORS**

The LED indicators complement the design of the BMW R 1200 GS perfectly – and thanks to reduced energy consumption and significantly longer bulb life, they're also a shining example of efficiency. Also available as an equipment option. To be fitted and/or enabled in a specialist workshop, and ideally at your BMW Motorrad dealership.

**PART NUMBER**

**LED indicators (four required)**  
Order number: 63 13 8 522 499\*



**EXTENDED FRONT MUDGUARD**

The larger mudguard emphasises the BMW R 1200 GS's Enduro style and offers improved spray protection. To be fitted and/or enabled in a specialist workshop, and ideally at your BMW Motorrad dealership.

**PART NUMBERS**

**Extended front mudguard**  
Order number: 77 14 8 561 425\*  
(+) Black "Style" radiator grilles  
Order number: 77 42 2 459 694  
(+) Clevis (two required)  
Order number: 46 63 8 521 396\*  
(+) M5 plug-in nut  
Order number: 46 63 8 532 314\*  
(+) M5 body panel screw  
Order number: 46 63 8 521 653\*

**PART NUMBER**

**Large top box, 49l**  
Order number: 77 43 8 551 996\*  
(+) Top box holder for luggage grid  
Order number: 77 44 8 523 743\*  
(+) Top box lid outer shell in Granite Grey Matt Metallic  
Order number: 77 43 8 354 934\*  
(o) Top box lid outer shell in Racing Red  
Order number: 77 43 8 354 935\*  
(+) Thread cutting screw (eight required)  
Order number: 07 14 7 698 893\*  
(+) Badge  
Order number: 51 14 8 164 924\*  
(+) Locking cylinder (with codes) for central locking with motorcycle  
Order number: 51 25 7 681 200\*  
(o) Repair kit for locking cylinder for central locking with motorcycle  
Order number: 51 25 7 698 204\*  
**Backrest pad for large top box, 49l**  
Order number: 77 44 8 561 434\*



**BAG FOR PILLION SEAT**

This waterproof bag attaches to the pillion seat and offers 14l of extra storage expandable to 18l – just the right amount for day trips or even the daily commute. Along with the tankbag, it's the perfect way to add storage space. For solo riding only. Not available in conjunction with pillion seat luggage grid or rally seats with luggage grid.

**PART NUMBER**

**Bag for pillion seat, 14-18 litres**  
Order number: 77 49 8 562 632\*



**DECOR STICKER SET GS**

The sticker set in Racing Red and Blackstorm Metallic is perfectly tailored to your vehicle. These highly durable stickers really stand out thanks to their vivid and metallic colour effects. The pack comes with instructions and application aids so they can be easily applied without creating air bubbles.

- Sticker set for: Mudguard, fuel tank, pannier, top box, aluminium rims (K50) + spoked rims with rim base decor
- Application aids (squeegee, application liquid, cleaning cloth)
- Installation instructions

**PART NUMBER**

**Decor sticker set GS**  
Order number: 77 31 2 455 684\*

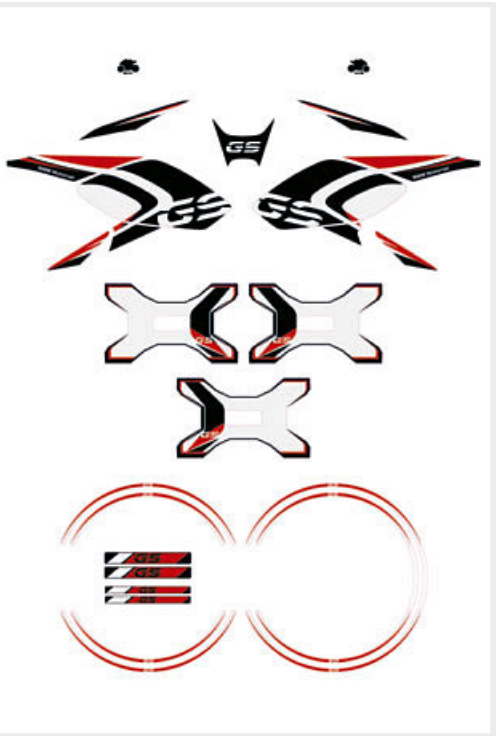

(+) = "and" – this item must be ordered at the same time  
(o) = "or" – this item may be ordered as an alternative option

\* Original BMW Motorrad equipment is available from your BMW Motorrad dealer.



## ERGONOMICS & COMFORT

### RALLYE WINDSHIELD

Ideal for off-road: small enough to give the rider a clear view of the ground and freedom of movement when riding in a standing position. Available clear or tinted. To be fitted and/or enabled in a specialist workshop, and ideally at your BMW Motorrad dealership.



#### PART NUMBERS

**Rallye windshield, clear** (image 1)  
Order number: 46 63 8 556 640\*  
Also available as special equipment, part of the BMW R 1200 GS Rallye version.

**(o) Rallye windshield, tinted** (image 2)  
Order number: 77 33 8 559 548\*

### TINTED WINDSHIELD

Underlines the powerful but refined look of the BMW R 1200 GS. To be fitted and/or enabled in a specialist workshop, and ideally at your BMW Motorrad dealership.



#### PART NUMBER

**Tinted windshield**  
Order number: 77 33 8 554 726\*



### ADJUSTABLE GEAR LEVER

Provides improved control when standing. With adjustable toe piece. Available in Silver or Black. To be fitted and/or enabled in a specialist workshop, and ideally at your BMW Motorrad dealership.

#### PART NUMBER

**Black adjustable gear lever**  
Order number: 77 25 2 455 704

**(o) Adjustable gear lever**  
Order number: 23 41 8 529 825



### BLACK REAR FOOT PEGS RACK

#### PART NUMBER

**Black rear foot pegs rack**  
Order number: 77 42 2 459 693

(+) = "and" – this item must be ordered at the same time  
(o) = "or" – this item may be ordered as an alternative option



### HIGH AND LOW RALLYE SEAT WITH LUGGAGE GRID

The narrow rallye seat is ergonomically designed for off-road riding, and comes in two heights. Not available in conjunction with pillion seat luggage grid. 20mm higher in conjunction with option code 547 sport suspension. Not available in conjunction with option code 413 pillion package.

#### PART NUMBERS

**Rallye seat, high, with luggage grid,** Black/Off-White (seat height: 880 mm; step length: 1,920 mm) (image 1)

Order number: 77 34 8 523 744\*  
Also available as an option in conjunction with the BMW R 1200 GS Rallye (option code 220, extra-high seat)

**(o) Rallye seat, low, with luggage grid, black/white and grey** (seat height: 860 mm/step length: 1,880 mm) (image 2)  
Order number: 52 53 8 564 243\*  
Part of the BMW R 1200 GS Rallye version.

**(+)** Covers for holes for grab handles  
Order number: 77 30 8 546 226\*  
Only required if standard grab-handles upgraded.

\* Original BMW Motorrad equipment is available from your BMW Motorrad dealer.



### COMFORT RIDER SEAT, HIGH OR LOW, AND COMFORT PILLION SEAT

These comfort seats for rider and pillion passenger offer increased comfort and an even more stylish design, thanks to an additional layer of soft foam and a soft, textured covering fabric. 20mm higher in conjunction with option code 547 sport suspension. Also available as an equipment option. (Option code 132 comfort seat, high, Black / option code 775 comfort seat, Black). Not available in conjunction with BMW R 1200 GS Rallye version. Comfort rider seats only available in conjunction with standard Black pillion seat or comfort pillion seat.

#### PART NUMBERS

**High comfort rider seat** (image 1)  
(seat height: 850/870 mm; step length: 1,920/1,940 mm)  
Order number: 52 53 8 560 683\*

**(o) Low comfort rider seat** (image 2)  
(seat height: 825/845 mm; step length: 1,880/1,900 mm)  
Order number: 52 53 8 560 682\*

**Comfort pillion seat**  
Order number: 52 53 8 560 684\*

### ADJUSTABLE RIDER SEATS (NOT SHOWN)

Optimum knee angle for taller riders, and a low version for easier mounting and handling. The adjustable rider seats are available in three heights. 20mm higher in conjunction with option code 547 sport suspension. Only available in conjunction with Black pillion seat (standard equipment on BMW R 1200 GS and on BMW R 1200 GS Exclusive version, included in option code 413 pillion package).

#### PART NUMBERS

**Rider seat, high, Black**  
(seat height: 870/890 mm; step length: 1,910/1,950 mm)  
Order number: 77 34 8 531 043\*

**Rider seat, Black**  
(seat height: 850/870 mm; step length: 1,870/1,910 mm)  
Order number: 52 53 8 532 737\*  
Standard height.

**Low rider seat, Black**  
(seat height: 820/840 mm; step length: 1,820/1,860 mm)  
Order number: 52 53 8 532 738\*  
Also available as an equipment option.

20mm higher in conjunction with option code 547 sport suspension. Only available in conjunction with Black pillion seat (standard equipment on BMW R 1200 GS and on BMW R 1200 GS Exclusive version, included in option code 413 pillion package).

Component of option code 499 lowered suspension (seat height with lowered suspension: 800 / 820 mm).

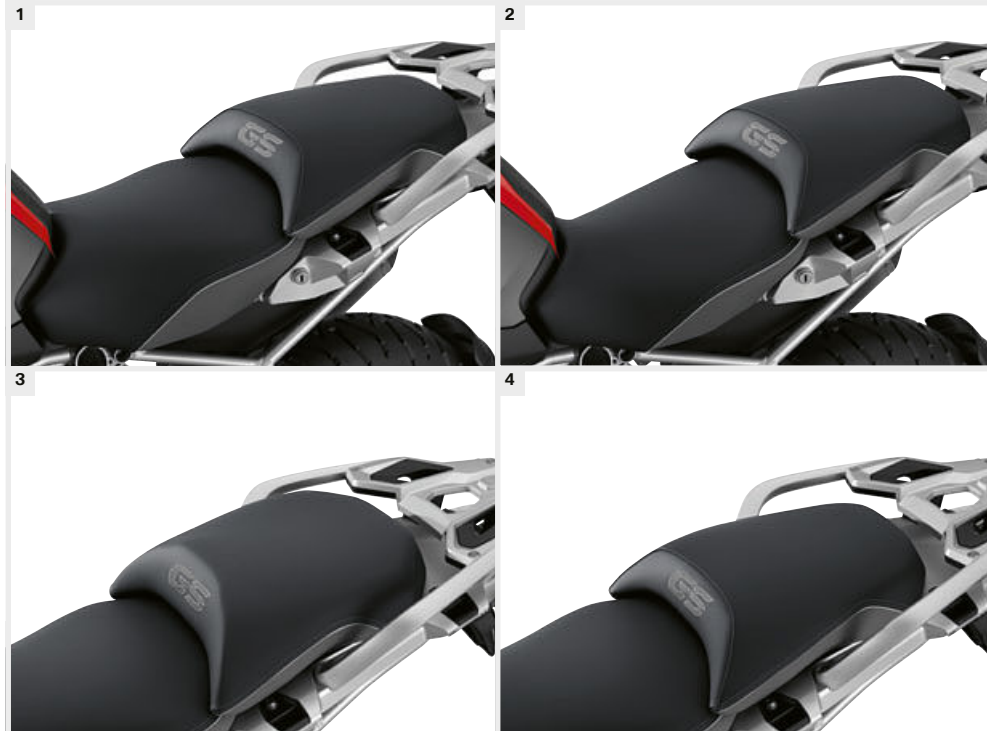

**EXCLUSIVE RIDER SEAT**

Instantly inviting, Hard-wearing Softtouch material gives the Exclusive seat a high-quality look and feel, and increases comfort for the rider. Available in three seat heights. 20 mm higher in conjunction with option code 547 sport suspension. Not available in conjunction with BMW R 1200 GS Rallye version. Exclusive rider seats only available in conjunction with Exclusive pillion seat or narrow Exclusive pillion seat.

**PART NUMBERS**

**High Exclusive rider seat** (image 1)  
(seat height: 870/890 mm; step length: 1,910/1,950 mm)  
Order number: 77 34 8 553 995\*

**Exclusive rider seat**  
(seat height: 850/870 mm; step length: 1,870/1,910 mm)  
(not shown)  
Order number: 77 34 8 552 146\*

**Exclusive rider seat, low (image 2)**  
• Exclusive rider seat, low  
(seat height: 820/840 mm; step length: 1,820/1,860 mm)  
Order number: 77 34 8 553 994\*

**Exclusive pillion seat** (image 3)  
Order number: 77 34 8 552 145\*

**Exclusive pillion seat, narrow** (image 4)  
Order number: 52 53 8 532 740\*



**ADJUSTABLE FOOTBRAKE LEVER**

Wider than before and height-adjustable thanks to a patented hinge mechanism, the footbrake lever improves the control of brake pressure when riding off-road in a standing position. To be fitted and/or enabled in a specialist workshop, and ideally at your BMW Motorrad dealership.

**PART NUMBER**

**Adjustable footbrake lever**  
Order number: 35 21 8 529 841\*

**PRO GEAR-SHIFT ASSIST (NOT SHOWN)**

Delivers smooth shifts without the use of the clutch. Also available as an equipment option. To be fitted and/or enabled in a specialist workshop, and ideally at your BMW Motorrad dealership.

**PART NUMBER**

**Pro gear-shift assist**  
Order number: 23 41 8 536 884\*

(+) Enabling code for Pro gear-shift assist  
Order number: 13 61 8 545 879\*

(+) = "and" – this item must be ordered at the same time  
(o) = "or" – this item may be ordered as an alternative option



**ADJUSTABLE RIDER FOOT PEGS**

These sprung rider foot pegs are designed for maximum comfort when seated. During standing off-road riding, the tread deflects to give a zigzag outline for better grip and control. Adjustable between three heights. Available in two colour combinations. To be fitted and/or enabled in a specialist workshop, and ideally at your BMW Motorrad dealership.

**PART NUMBERS**

**Adjustable rider foot pegs, Black, left** (image 1)

Order number: 77 25 2 452 958\*

(+) Rider foot peg, adjustable, Black, right

Order number: 77 25 2 452 960\*

(+) Torsion spring (two required)

Order number: 46 71 8 526 107\*

**Adjustable rider foot pegs, left** (image 2)

Order number: 77 25 8 525 369\*

(+) Rider foot peg, adjustable, right

Order number: 77 25 8 525 370\*

(+) Torsion spring (two required)

Order number: 46 71 8 526 107\*

**CRUISE CONTROL**

Also available as an equipment option. For more detailed information, contact your BMW Motorrad dealership or go online at [bmw-motorrad.com](http://bmw-motorrad.com). To be fitted and/or enabled in a specialist workshop, and ideally at your BMW Motorrad dealership.



**HEATED GRIPS AND SWITCHES**

Warm hands feel good, which is why these heated handlebar grips have two settings designed to keep hands and fingers pleasantly warm. Also available as an equipment option. For more detailed information, contact your BMW Motorrad dealership or go online at [bmw-motorrad.com](http://bmw-motorrad.com). To be fitted and/or enabled in a specialist workshop, and ideally at your BMW Motorrad dealership.



\* Original BMW Motorrad equipment is available from your BMW Motorrad dealer.



**ENDURO FOOT PEGS**

On off-road terrain, these wider, longer Enduro foot pegs ensure better control while allowing riders to comfortably use the gear and footbrake levers. To be fitted and/or enabled in a specialist workshop, and ideally at your BMW Motorrad dealership. Part of the BMW R 1200 GS Rallye version.

**PART NUMBERS**

**Enduro foot peg, left**  
Order number: 46 71 8 529 843\*

(+) Enduro foot peg, right  
Order number: 46 71 8 529 844\*

(+) Torsion spring (two required)  
Order number: 46 71 8 526 107\*

**PRO RIDING MODES (NOT SHOWN)**

Also available as an equipment option. For more detailed information, contact your BMW Motorrad dealership or go online at [bmw-motorrad.com](http://bmw-motorrad.com). To be fitted and/or enabled in a specialist workshop, and ideally at your BMW Motorrad dealership.

**HILL START CONTROL (NOT SHOWN)**

Park or pull away on up or down gradients, even with a pillion passenger and heaps of luggage on board. Also available as an equipment option. For more detailed information, contact your BMW Motorrad dealership or go online at [bmw-motorrad.com](http://bmw-motorrad.com). To be fitted and/or enabled in a specialist workshop, and ideally at your BMW Motorrad dealership.

## NAVIGATION AND COMMUNICATION



### BMW MOTORRAD NAVIGATION SYSTEMS

Where am I? Where do I want to go, and what's the most scenic way to get there?

BMW Motorrad navigation devices show you where to go. Made specifically for motorcyclists, they're easy to fit and use – even with gloves on – and come with lifetime map updates.

The new BMW Motorrad Navigator VI is your ticket to the tour of your dreams.

A whole new level of adventure awaits thanks to the “winding roads” route option, “avoid motorways” feature and the “round trip” function, which configures journeys based on time, distance or stopover. The circular polarization filter (CPOL) on the display minimizes reflection and improves contrast, ensuring the screen is easy to read, even in direct sunlight. 16 GB of flash storage, and the ability to stream music from your smartphone, are the ultimate luxury.

“My motorcycle” page available only in conjunction with option code 221 Pro on-board computer

Only available in conjunction with navigation device preparation (also available as option code 272).

#### PART NUMBERS

**BMW Motorrad Navigator VI**  
(with map data for Europe) (top image)  
Order number: 77 52 8 355 994

**(o) BMW Motorrad Navigator VI** (without map data)  
Order number: 77 52 8 356 005\*



(+) = “and” – this item must be ordered at the same time  
(o) = “or” – this item may be ordered as an alternative option

## SAFETY



### HAND PROTECTORS

For effective protection against wind, rain, low branches and flying stones.  
Also available as an equipment option.

#### PART NUMBER

**Hand protectors**  
Order number: 77 32 8 525 880\*



### CYLINDER HEAD COVER GUARD

If the worst comes to the worst, the optional cylinder head cover guard provides additional protection against damage. And it also underscores the exceptional design of the boxer engine.

#### PART NUMBER

**Cylinder head cover guard**  
Order number: 77 14 8 533 745\*

### STAINLESS STEEL ENGINE PROTECTION BAR

The stainless steel engine protection bar provides effective protection for the cylinders without compromising the lean angle. Also combines perfectly with the cylinder head cover guard.

#### PART NUMBERS

**Engine protection bar, left**  
Order number: 77 14 8 557 607\*

(+) Engine protection bar, right  
Order number: 77 14 8 557 608\*

(+) Bushing (two required)  
Order number: 77 14 8 548 683\*

(+) Cylinder screw M8x30 (two required)  
Order number: 07 12 9 907 381\*

(+) Cylinder screw M8x35 (two required)  
Order number: 07 12 9 908 654\*



\* Original BMW Motorrad equipment is available from your BMW Motorrad dealer.



### LED AUXILIARY HEADLIGHTS

The LED auxiliary headlights deliver increased safety when visibility is poor, e.g. in fog, snow and rain. Also available as an equipment option. To be fitted and/or enabled in a specialist workshop, and ideally at your BMW Motorrad dealership. The auxiliary headlights are approved for use as fog lights, and may only be used in poor weather conditions. Country-specific road traffic regulations apply.

#### PART NUMBERS

- LED auxiliary headlights** (two required)  
Order number: 63 17 8 556 937\*
- (+) **Holder set for auxiliary headlights**  
Order number: 77 51 8 389 189\*
- (+) **Cable harness for auxiliary headlights**  
Order number: 61 12 8 395 601\*
- (+) **Additional switch for auxiliary headlights**  
Order number: 61 31 8 533 473\*
- (+) **Body panel screw**  
Order number: 46 63 8 534 938\*
- (+) **Cable clamp**  
Order number: 32 72 8 534 366\*

### ABS PRO (NOT SHOWN)

To be fitted and/or enabled in a specialist workshop, and ideally at your BMW Motorrad dealership. For more detailed information, contact your BMW Motorrad dealership or go online at [bmw-motorrad.com](http://bmw-motorrad.com).

### TPC (TYRE PRESSURE CONTROL, NOT SHOWN)

To be fitted and/or enabled in a specialist workshop, and ideally at your BMW Motorrad dealership. For more detailed information, contact your BMW Motorrad dealership or go online at [bmw-motorrad.com](http://bmw-motorrad.com).



### HEADLIGHT GUARD

The headlight guard protects the headlight from damage when riding off-road. It is not approved for road use. Screws on and off quickly and easily. To be fitted and/or enabled in a specialist workshop, and ideally at your BMW Motorrad dealership.

#### PART NUMBERS

- Headlight guard** (for off-road use only)  
Order number: 77 51 8 529 214\*

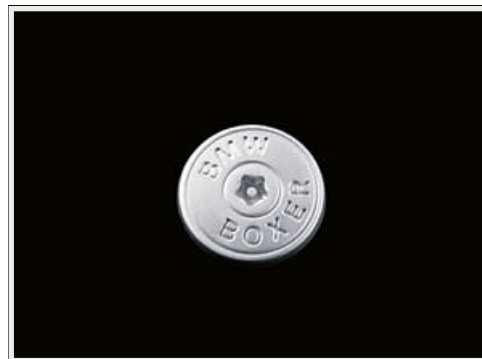

### SAFETY SCREW FOR OIL FILLER CAP

Small, yet refined: this small safety screw is made of milled aluminium and prevents unauthorized removal of the oil filler cap.

#### PART NUMBER

- Safety screw for oil filler cap**  
Order number: 71 60 7 696 117\*

(+) = "and" – this item must be ordered at the same time  
(o) = "or" – this item may be ordered as an alternative option



### ENDURO ALUMINIUM BASH PLATE

This sturdy Enduro aluminium bash plate was specially constructed for off-road use and provides optimal protection for the lower section of the engine. To be fitted and/or enabled in a specialist workshop, and ideally at your BMW Motorrad dealership.

#### PART NUMBER

- Enduro aluminium bash plate** (image 1)  
Order number: 77 14 8 533 747\*
- Enduro aluminium bash plate, Black** (image 2)  
Order number: 77 14 2 460 287

\* Original BMW Motorrad equipment is available from your BMW Motorrad dealer.



### RADIATOR GRILLE

A must for off-road riders: The two grilles provide effective radiator protection against flying stones. To be fitted and/or enabled in a specialist workshop, and ideally at your BMW Motorrad dealership. Part of the BMW R 1200 GS Rallye version.

#### PART NUMBERS

- Radiator grille, left**  
Order number: 46 63 8 556 647\*
- (+) **Radiator grille, right**  
Order number: 46 63 8 556 648\*

### ANTI-THEFT ALARM SYSTEM (NOT SHOWN)

If the motorcycle is moved or struck violently, the system responds with a clearly audible signal and a flashing warning light. Also available as an equipment option. To be fitted and/or enabled in a specialist workshop, and ideally at your BMW Motorrad dealership.

#### PART NUMBER

- Anti-theft alarm system**  
Order number: 77 53 8 554 348\*
- (+) **Lens screw and washer**  
Order number: 07 14 9 141 517\*



### FRAME PROTECTOR

The black plastic frame protector provides effective protection against scratching, and chafing from motorcycle boots. Mounting instructions are available from your BMW Motorrad dealership. Part of the BMW R 1200 GS Rallye version.

#### PART NUMBERS

- Frame protector, left**  
Order number: 46 51 8 560 671\*
- (+) **Frame protector, right**  
Order number: 46 51 8 560 672\*
- (+) **Tensioner** (six required)  
Order number: 32 73 7 687 119\*

## EQUIPMENT FOR THE BMW R 1200 GS ADVENTURE.



## HP PARTS

### HP SPORT SILENCER

Top-grade parts for top-quality sound: made entirely of titanium, with laser-etched logo, carbon end cap and heat shield. The HP sport silencer turns every ride into a thrilling experience. Approx. 0.5kg lighter than the standard silencer.

For more detailed information, contact your BMW Motorrad dealership or go online at [bmw-motorrad.com](http://bmw-motorrad.com)

#### PART NUMBER

**HP sport silencer**  
Order number: 77 11 8 569 593\*



### HP MILLED BRAKE AND CLUTCH LEVERS

Made out of corrosion-resistant, anodized aluminium, the CNC-milled HP brake and clutch levers are both stylish and highly practical.

To be fitted and/or enabled in a specialist workshop, and ideally at your BMW Motorrad dealership.

#### PART NUMBERS

**HP milled clutch lever**  
Order number: 77 25 8 554 323\*  
(+) HP milled brake lever  
Order number: 77 25 8 554 324\*



(+) = "and" – this item must be ordered at the same time  
(o) = "or" – this item may be ordered as an alternative option

## STORAGE

1



### ALUMINIUM TOP BOX AND BACKREST PAD

The waterproof top box has a capacity of 32 litres and lashing eyes for securing additional luggage. And with the optional backrest pad added, it provides increased comfort for the pillion passenger.

2



#### PART NUMBERS

**Black aluminium top box, 32l** (image 1)  
Order number: 77 43 2 455 447

**Aluminium top box** (image 2)  
Order number: 77 43 8 562 407\*

(+) Locking cylinder (with codes) for central locking with motorcycle (one required)

Order number: 77 49 8 544 513\*

(o) Repair kit for locking cylinder (two required)  
Order number: 77 49 8 544 517\*

**Backrest pad for aluminium top box**  
Order number: 77 44 8 546 808\*

1



### ALUMINIUM PANNIERS

Together, these robust panniers offer a total capacity of 80 litres. They have two locks each, plus lashing eyes for additional luggage. Central locking is possible.

#### PART NUMBERS

**Aluminium pannier, 44l** (image 1)  
Order number: 77 41 8 562 409

**Aluminium pannier, right, 36l**  
Order number: 77 41 8 562 410

**Black aluminium pannier, left, 44l**  
Order number: 77 41 2 455 445

**Black aluminium pannier, right, 36l** (image 2)  
Order number: 77 41 2 455 446

(+) 77 43 8 543 993 mounting kit

2



\* Original BMW Motorrad equipment is available from your BMW Motorrad dealer.



### INNER BAGS FOR ALUMINIUM PANNIERS AND TOP BOX

Waterproof inner bags are also available for the aluminium panniers and the top box. They make loading and unloading easier, protect luggage, and come with straps that make them easy to transport. The inner bags can also be attached to the outside of the aluminium panniers using the four enclosed straps, and they provide additional storage space.

#### PART NUMBERS

**Inner bag for aluminium pannier, left**

Order number: 77 41 8 543 197\*

**Inner bag for aluminium pannier, right**

Order number: 77 41 8 543 199\*

**Inner bag for aluminium top box**

Order number: 77 43 8 543 194\*



### PANNIER RACKS FOR ALUMINIUM PANNIERS

As part of the aluminium luggage system, these electropolished stainless-steel pannier racks deliver exactly what they promise. Also available as an equipment option.

Mounting instructions are available from your BMW Motorrad dealership.

#### PART NUMBERS

**Pannier rack, left**

Order number: 46 54 8 520 067\*

(+) Pannier rack, right

Order number: 46 54 8 520 068\*

(+) Cross pipe for pannier rack

Order number: 46 54 8 520 069\*

**Pannier rack, black, left (not shown)**

Order number: 77 41 2 455 698\*

(+) Black pannier rack, right

Order number: 77 41 2 455 699

(+) Black pannier rack, rear cross brace

Order number: 77 41 2 455 700

(+) Pannier rack mounting kit for aluminium panniers

Order number: 77 41 8 543 993\*



### ATACAMA LUGGAGE SYSTEM

Versatile softbag system with various features. Specially made for globetrotters who aren't afraid of tough conditions, with extremely tear-resistant materials and removable watertight inner bags. Thanks to a quick-fastening system, the side bags can be quickly attached to the luggage rack and are just as easy to remove.

Backpack-style luggage roll.

Only available in conjunction with pannier mountings for aluminium panniers.

#### PART NUMBERS

**Atacama side bag, 25 and 35 litres**

Order number: 77 40 2 451 375\*

(+) Atacama side bag adapter

Order number: 77 40 2 451 360\*

**Atacama luggage roll, 40 litres**

Order number: 77 40 2 451 381\*

(+) = "and" – this item must be ordered at the same time  
(o) = "or" – this item may be ordered as an alternative option



### LUGGAGE GRID

The luggage grid can be fitted in place of the pillion seat. When the aluminium panniers are also attached, this creates a large flat space where sizeable items of luggage can be stored securely near the vehicle's centre of gravity.

Not available in conjunction with rally seat with luggage grid.

Only available in conjunction with part number 77 30 8 546 226 (cover kit for holes for grab handles) if the standard pillion passenger grab handles have been removed.

#### PART NUMBERS

**Luggage grid**

Order number: 77 44 8 523 742\*

(+) Covers for holes for grab handles

Order number: 77 30 8 546 226\*



### TANKBAG

The lockable main compartment of the tankbag is waterproof and has a capacity of 12–16 litres. The tankbag has a water-resistant map pocket. The capacity of the main compartment can be expanded from 12 to 16 litres, and the water-resistant outer pocket can safely hold a 0.5-litre PET bottle.

#### PART NUMBER

**Tank bag**

Order number: 77 45 8 543 190\*



### BLACK TOP CASE HOLDER FOR ALUMINIUM TOP BOX

#### PART NUMBERS

**Black top case holder for aluminium top box**

Order number: 77 41 2 455 701



### BAG FOR PILLION SEAT

This waterproof bag attaches to the pillion seat and offers 14l of extra storage expandable to 18l – just the right amount for day trips or even the daily commute. Along with the tankbag, it's the perfect way to add storage space.

For solo riding only.

Not available in conjunction with rally seat with luggage grid.

#### PART NUMBER

**Bag for pillion seat**

Order number: 77 49 8 562 633\*

\* Original BMW Motorrad equipment is available from your BMW Motorrad dealer.

## DESIGN



### LED INDICATORS

The LED indicators complement the design of the BMW R 1200 GS Adventure perfectly – and thanks to reduced energy consumption and significantly longer bulb life, they're also a shining example of efficiency. Also available as an equipment option. To be fitted and/or enabled in a specialist workshop, and ideally at your BMW Motorrad dealership.

#### PART NUMBER

**LED indicators, front** (two required)  
Order number: 63 13 8 522 499\*

**LED indicators, rear** (two required)  
Order number: 63 23 8 522 500\*

### GS DECOR STICKER SET

The sticker set in Racing Red and Blackstorm Metallic is perfectly tailored to your vehicle. These highly durable stickers really stand out thanks to their vivid and metallic colour effects. The pack comes with instructions and application aids so they can be easily applied without creating air bubbles.

#### Set contents:

- Sticker set for: Mudguard, fuel tank, pannier, top box, aluminium rims (K50) + spoked rims (K51 Adventure) rim base decor
- Application aids (squeegee, application liquid, cleaning cloth)
- Installation instructions

#### PART NUMBERS

**R 1200 GS Adventure sticker set**  
Order number: 77 31 2 455 683



## ERGONOMICS AND COMFORT



### HIGH TINTED WINDSHIELD/TINTED WIND DEFLECTOR

Underlines the powerful but refined look of the BMW R 1200 GS Adventure. To be fitted and/or enabled in a specialist workshop, and ideally at your BMW Motorrad dealership.

#### PART NUMBERS

**Tinted windshield** (not shown)  
Order number: 77 33 8 554 726\*

**High windshield, tinted**  
Order number: 77 33 8 554 727\*

**Tinted wind deflector**  
Order number: 77 33 8 545 881\*

### RALLYE SEAT WITH LUGGAGE GRID

The narrow width of the Rallye seat keeps the ground within easy reach, making it ideal for off-road riding. It also comes with a raised seat position and firmer padding.

Not available in conjunction with luggage grid.

#### PART NUMBER

**Rallye seat with luggage grid, Black/Grey** (seat height: 895 mm; step length: 1,970 mm)  
Order number: 77 34 8 523 744\*



### LOW RIDER SEAT, BLACK

Adjustable downwards by 30 mm, this low rider seat makes climbing on and handling easier. Only available in conjunction with appropriate pillion seat.

#### PART NUMBER

**Low rider seat, Black** (seat height: 840/860 mm; step length: 1,850/1,890 mm)  
Order number: 52 53 8 532 738\*



### PRO RIDING MODES (NOT SHOWN)

Also available as an equipment option. For more detailed information, contact your BMW Motorrad dealership or go online at [bmw-motorrad.com](http://bmw-motorrad.com). To be fitted and/or enabled in a specialist workshop, and ideally at your BMW Motorrad dealership.

**OTHER SEATS: (NOT SHOWN)**

Only available in conjunction with appropriate pillion or rider seat.

**PART NUMBERS**

**Rider seat, Olive Grey/Black**  
(seat height: 890/910 mm;  
step length: 1,950/1,990 mm)  
Order number: 52 53 8 540 917\*

**Rider seat, Blue/Black**  
(seat height: 890/910 mm;  
step length: 1,950/1,990 mm)  
Order number: 52 53 8 537 858\*

**Rider seat, Red/Black**  
(seat height: 890/910 mm;  
step length: 1,950/1,990 mm)  
Order number: 52 53 8 560 506\*

**Exclusive rider seat, low**  
(seat height: 840 / 860 mm /  
step length: 1,850/1,890 mm)  
Order number: 77 34 8 553 994\*

**Exclusive rider seat**  
(seat height: 870 / 890 mm /  
step length: 1,910/1,950 mm)  
Order number: 77 34 8 552 146\*

**Exclusive rider seat, high**  
(seat height: 890 / 910 mm /  
step length: 1,950/1,990 mm)  
Order number: 77 34 8 553 995\*

**Exclusive pillion seat**  
Order number: 77 34 8 552 145\*

**Exclusive pillion seat, narrow**  
Order number: 52 53 8 532 740\*

**Pillion seat in Blue/Black**  
Order number: 52 53 8 537 859\*

**Pillion seat in Olive Grey/Black**  
Order number: 52 53 8 540 919\*

**Pillion seat in Red/Black**  
Order number: 52 53 8 560 503\*

**HEATED GRIPS AND SWITCHES (NOT SHOWN)**

Also available as an equipment option.  
For more detailed information, contact your BMW Motorrad dealership or go online at [bmw-motorrad.com](http://bmw-motorrad.com).

To be fitted and/or enabled in a specialist workshop, and ideally at your BMW Motorrad dealership.



**CRUISE CONTROL**

Also available as an equipment option.  
For more detailed information, contact your BMW Motorrad dealership or go online at [bmw-motorrad.com](http://bmw-motorrad.com).  
To be fitted and/or enabled in a specialist workshop, and ideally at your BMW Motorrad dealership.



**PRO GEAR-SHIFT ASSIST**

Delivers smooth shifts up and down without the use of the clutch. Also available as an equipment option.  
To be fitted and enabled in a specialist workshop, and ideally at your BMW Motorrad dealership.

**PART NUMBERS**

**Pro gear-shift assist**  
Order number: 23 41 8 536 884\*  
Enabling code for Pro gear-shift assist  
Order number: 13 61 8 545 879\*



**ADJUSTABLE GEAR LEVER**

Provides improved control when standing.  
With adjustable toe piece.  
To be fitted and/or enabled in a specialist workshop, and ideally at your BMW Motorrad dealership.

**PART NUMBER**

**Adjustable gear lever**  
Order number: 77 25 2 455 704



**BLACK REAR FOOT PEGS RACK**

**PART NUMBER**

**Black rear foot pegs rack**  
Order number: 77 42 2 459 693

**ADJUSTABLE RIDER FOOT PEGS**

Spring-loaded rider foot pegs offer additional comfort when riding in a seated position and more control over the vehicle on off-road terrain.  
To be fitted and/or enabled in a specialist workshop, and ideally at your BMW Motorrad dealership.



**PART NUMBERS**

**Adjustable rider foot pegs, Black, left** (image 1)  
Order number: 77 25 2 452 958\*  
(+) Rider foot peg, adjustable, Black, right  
Order number: 77 25 2 452 960\*  
(+) Torsion spring (two required)  
Order number: 46 71 8 526 107\*

**Adjustable rider foot pegs, left** (image 2)  
Order number: 77 25 8 525 369\*  
(+) Rider foot peg, adjustable, right  
Order number: 77 25 8 525 370\*  
(+) Torsion spring (two required)  
Order number: 46 71 8 526 107\*



(+) = "and" – this item must be ordered at the same time  
(o) = "or" – this item may be ordered as an alternative option



\* Original BMW Motorrad equipment is available from your BMW Motorrad dealer.



## NAVIGATION AND COMMUNICATION



### BMW MOTORRAD NAVIGATION SYSTEMS

Where am I? Where do I want to go, and what's the most scenic way to get there? BMW Motorrad navigation devices show you where to go. Made specifically for motorcyclists, they're easy to fit and use – even with gloves on – and come with lifetime map updates.

The new BMW Motorrad Navigator VI is your ticket to the tour of your dreams. A whole new level of adventure awaits thanks to the “winding roads” route option, “avoid motorways” feature and the “round trip” function, which configures journeys based on time, distance or stopover. The circular polarization filter (CPOL) on the display minimizes reflection and improves contrast, ensuring the screen is easy to read, even in direct sunlight. 16 GB of flash storage, and the ability to stream music from your smartphone, are the ultimate luxury.

Only available in conjunction with “Navigation device preparation” (also available as an equipment option, option code 272)

“My motorcycle” page available only in conjunction with option code 221 Pro on-board computer

#### PART NUMBERS

**BMW Motorrad Navigator VI**  
(with map data for Europe)  
Order number: 77 52 8 355 994

(o) BMW Motorrad Navigator VI (without map data)  
Order number: 77 52 8 356 005\*

#### Retrofit preparation for navigation device

For more detailed information, contact your BMW Motorrad dealership or go online at [bmw-motorrad.com](http://bmw-motorrad.com).

## SAFETY

### TPC (TYRE PRESSURE CONTROL, NOT SHOWN)

For more detailed information, contact your BMW Motorrad dealership or go online at [bmw-motorrad.com](http://bmw-motorrad.com)

To be fitted and/or enabled in a specialist workshop, and ideally at your BMW Motorrad dealership.

### ANTI-THEFT ALARM SYSTEM (NOT SHOWN)

If the motorcycle is moved or struck violently, the system responds with a clearly audible signal and a flashing warning light. Also available as an equipment option.

To be fitted and/or enabled in a specialist workshop, and ideally at your BMW Motorrad dealership.

#### PART NUMBERS

**Anti-theft alarm system**

Order number: 77 53 8 554 348\*

(+) Lens screw and washer

Order number: 07 14 9 141 517\*



### SAFETY SCREW FOR OIL FILLER CAP

Small, yet refined: this small safety screw is made of milled aluminium and prevents unauthorized removal of the oil filler cap.

#### PART NUMBER

**Safety screw for oil filler cap**

Order number: 71 60 7 696 117\*



### LED AUXILIARY HEADLIGHTS

The LED auxiliary headlights deliver increased safety when visibility is poor, e.g. in fog, snow and rain. Also available as an equipment option.

To be fitted and/or enabled in a specialist workshop, and ideally at your BMW Motorrad dealership.

The auxiliary headlights are approved for use as fog lights, and may only be used in poor weather conditions. Country-specific road traffic regulations apply.



#### PART NUMBERS

**LED auxiliary headlights** (two required)  
Order number: 77 17 8 556 937

(+) Bracket for LED auxiliary headlights  
Order number: 77 51 8 389 189

(+) Cable harness for LED auxiliary headlights  
Order number: 61 12 8 395 601

(+) Additional switch for LED auxiliary headlights  
Order number: 61 31 8 533 473

(+) Body panel screw  
Order number: 07 12 9 907 413

(+) Cable clamp  
Order number: 32 72 8 534 366



### **HEADLIGHT GUARD**

The headlight guard protects the headlight from damage when riding off-road. It is not approved for road use. It features a snaplock system for quick, easy attachment and removal.

To be fitted and/or enabled in a specialist workshop, and ideally at your BMW Motorrad dealership.

#### **PART NUMBER**

**Headlight guard** (for off-road use only)  
Order number: 77 51 8 529 214\*



### **ENDURO ALUMINIUM BASH PLATE**

This sturdy Enduro aluminium bash plate was specially constructed for off-road use and provides optimal protection for the lower section of the engine.

To be fitted and/or enabled in a specialist workshop, and ideally at your BMW Motorrad dealership.

#### **PART NUMBER**

**Enduro aluminium bash plate** (image 1)  
Order number: 77 14 8 533 747\*

**Enduro aluminium bash plate, Black** (image 2)  
Order number: 77 14 2 460 287

(+) = "and" – this item must be ordered at the same time  
(o) = "or" – this item may be ordered as an alternative option



\* Original BMW Motorrad equipment is available from your BMW Motorrad dealer.

## ***ACCESSORIES FOR ALL MODELS***

<b>Tyres</b>	246
<b>Storage</b>	248
<b>Navigation</b>	249
<b>Safety</b>	250
<b>Maintenance &amp; Technology</b>	251
<b>Original BMW Care Products</b>	254
<b>ADVANTEC Original BMW Engine Oil</b>	255





## **YOUR TYRES: THE PERFECT PAIR FOR MAINTAINING WHEEL GRIP DURING CORNERING.**

They are your direct contact to the road. The decisive link against the centrifugal forces in the curve: your tyres. There is hardly anything that influences your motorcycle's handling more. There is a lot of discussion about the right tyres because anyone who has first-hand experience knows that two identical motorcycles drive very differently if they have different tyres.

Your BMW motorcycle dealership offers a selection of suitable tyres from well-known manufacturers for your bike. They are all chosen based on very extensive tyre tests. As preferences often vary depending on riding style and ability, many different types of tyres are tested and they are only given BMW Motorrad's official seal of approval after thorough testing. This is how we make sure that your tyres, in combination with your bike, perform optimally depending on the situation – when accelerating, cornering and braking.

So it makes sense to both have your BMW serviced at our trained BMW Motorrad dealership and to have it fitted with a fresh set of tyres when necessary. With this „One-Stop“ you not only save time, you can also make sure that you're driving using the perfect tyres. Your BMW Motorrad dealership knows exactly which tyre is right for your riding style and your bike. Guarantees many thousands of kilometres of riding fun.

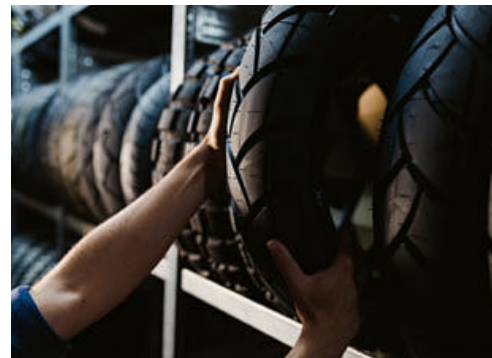

## **YOUR BIKE. YOUR TYRES. THE RIGHT COMBINATION DOES THE TRICK.**



### **ON THE ROAD WITH THE BEST TYRES.**

Your BMW Motorrad dealership is not only a specialist for your BMW, but also for the right tyres. So they know exactly which Enduro, Touring or Sports tyres are the best for you and your riding style. The right combination of tread, tyre contour, rubber compound, vehicle geometry and other factors make the perfect compound for you and your BMW.

There are a number of helpful tools around the topic of tyres, which we present to you in this catalogue. For example, tyre puncture sets, mini foot pumps and multifunctional tools. This way you are always safe on gravel, sand and asphalt.

## STORAGE

### LUGGAGE ROLL, 50 L

The waterproof luggage roll has a large opening, making it easy to pack whatever you might need to take with you. The small mesh outer pocket and waterproof zipped inner pockets provide space for less bulky items. Adjustable compression straps fitted for volume adjustment. The luggage roll also comes with an adjustable and detachable shoulder strap plus a padded carry handle.

#### PART NUMBER

**Luggage roll, 50l**  
Order number: 77 49 8 550 346\*



### SMALL SOFTBAG, 30l-35l AND LARGE SOFTBAG, 50l-55l

These handy softbags have a waterproof main compartment, water-repellent outer pockets, carry handles and a shoulder strap, plus length-adjustable snaplock straps for attaching to the motorcycle.



#### PART NUMBERS

**Small softbag, 30-35 l**  
Order number: 77 49 8 549 323\*  
**Large softbag, 50-55 l**  
Order number: 77 49 8 549 320\*

### BAG FOR LUGGAGE GRID

A practical bag for the luggage grid to replace or be used alongside the tankbag. The bag, which can be installed on all BMW luggage racks, has a waterproof main compartment thanks to its roll-up closure. With 4.5l capacity, it's ideal for a day trip.

#### PART NUMBER

**Bag for luggage grid**  
Order number: 77 49 8 562 634\*



### VARIABLE INSERT FOR TANKBAG

The perfect complement to the tankbag: the variable insert is a handy way to organize your luggage, and keeps everything in place even around tight bends.

#### PART NUMBER

**Variable insert for tankbag**  
Order number: 77 49 8 546 687\*



## NAVIGATION



### BMW USB ADAPTER

Only for charging. Not a multimedia function.  
Only available in conjunction with the dual USB charger.

#### PART NUMBER

**BMW lightning USB adapter**  
Order number: 61 12 2 354 478\*



### BMW MOTORRAD DUAL USB CHARGER WITH CABLE

The dual USB charger can charge up to two mobile devices (smartphone, MP3 player, tablet, digital camera, etc.) at the same time during your journey, via the 12-volt socket. It charges all of the latest smartphones in quick time with a maximum current of 2 x 2 amps.

### CAR KIT FOR BMW MOTORRAD NAVIGATOR

In conjunction with the optional car kit, the BMW Motorrad Navigator VI can also be used in a car as a hands-free device.  
Device shown: BMW Motorrad Navigator VI

#### PART NUMBER

**Car kit for BMW Motorrad Navigator VI**  
Order number: 77 528 544 460\*



#### PART NUMBER

**BMW Motorrad dual USB charger with 60 cm cable**  
Order number: 77 52 2 414 855\*  
**BMW Motorrad dual USB charger with 120 cm cable**  
Order number: 77 52 2 414 856\*



\* Original BMW Motorrad equipment is available from your BMW Motorrad dealer.

## SAFETY



### FIRST-AID KIT

Compact waterproof case containing bandages and dressings. The large first-aid kit also complies with the DIN standard for motorcycle first-aid kits.



#### PART NUMBER

##### First-aid kit, large

Order number: 72 60 2 317 554\*

##### First-aid kit, small

Order number: 72 60 7 695 290\*

## MAINTENANCE AND TECHNOLOGY



### ON-BOARD TOOL KIT

The on-board service kit allows riders to perform simple maintenance and repair work while on the move. Availability and order numbers vary according to model.

For more detailed information, contact your BMW Motorrad dealership or go online at [bmw-motorrad.com](http://bmw-motorrad.com).

#### PART NUMBER

##### On-board toolkit

Order number: 71 60 7 720 256\*

Order number: 71 60 7 702 754\*



### BMW MOTORRAD BATTERY CHARGER

Ideal for winter storage: the charger is easy to be used and can be left plugged in for long periods. Pulsed charging prolongs the life and performance of the battery. For more detailed information, contact your BMW Motorrad dealership or go online at [bmw-motorrad.com](http://bmw-motorrad.com).

Observe versions in different countries.



### BRAKE DISC LOCK WITH ANTI-THEFT ALARM SYSTEM

The ideal theft deterrent when you're out with your bike. The integrated anti-theft alarm system, locking bolt and hardened-steel casing will make any thief think twice. It's also compact and easy to stow away.

#### PART NUMBER

##### Brake disc lock with anti-theft alarm system

Order number: 77 25 2 414 845\*

### BMW MOTORRAD MINI FOOT PUMP

The mini foot pump is a genuine all-rounder. Fitted with a digital manometer, it's ideal for increasing air pressure in the air damping system, adjusting tyre pressure and even pumping up car and bike tyres, balls and mattresses.

#### PART NUMBER

##### BMW Motorrad mini foot pump

Order number: 71 60 7 715 824\*



### MOTORCYCLE CARPET

#### PART NUMBER

##### Motorcycle carpet

Order number: 77 02 2 414 857\*



#### PART NUMBER

##### BMW Motorrad battery charger

Order number: 77 02 8 551 896\* 230V/ECE

Order number: 77 02 8 551 897\* 230V/ECE

Order number: 77 02 8 551 898\* 110V (US)



**VEHICLE COVER**

Robust vehicle cover for outdoor use. With display window showing the license plate. For more detailed information, contact your BMW Motorrad dealership or go online at [bmw-motorrad.com](http://bmw-motorrad.com).



**PART NUMBERS**

**Vehicle cover**  
Order number: 71 60 7 689 674\*

**TYRE PRESSURE TRAVEL SET (NOT SHOWN)**

**PART NUMBER**

**Tyre pressure travel set**  
Order number: 71 11 2 414 852\*



**MULTI-PURPOSE TOOLKIT**

With the BMW Motorrad multi-purpose toolkit, you've got every tool you might need to hand. It's essential for every rider, whether at home or out on tour.

**PART NUMBER**

**Multi-purpose toolkit**  
Order number: 71 60 2 414 858\*

**LED TORCH (NOT SHOWN)**

Versatile and powerful LED torch with battery. The battery can be charged via a standard plug socket or car cigarette lighter. For more detailed information, contact your BMW Motorrad dealership or go online at [bmw-motorrad.com](http://bmw-motorrad.com).

**PART NUMBER**

**LED torch**  
Order number: 71 60 2 414 853\*

**BREAKDOWN REPAIR KIT FOR TUBELESS TYRES**

Absolutely essential on a long-distance tour – the complete puncture repair kit.

**PART NUMBER**

**Breakdown repair kit for tubeless tyres**  
Order number: 71 112 447 552\*



**INDOOR VEHICLE COVER**

Protects motorcycle against dust and scratching and prevents the build-up of condensation. Three versions, which vary in shape and design (for covering different model types).

For more detailed information, contact your BMW Motorrad dealership or go online at [bmw-motorrad.com](http://bmw-motorrad.com).

**PART NUMBERS**

**Indoor vehicle cover (image 1)**  
Order number: 77 02 8 555 890\*

**Large indoor vehicle cover (image 2)**  
Order number: 77 02 8 551 270\*

**Indoor vehicle cover (image 3)**  
Order number: 77 02 8 553 868\*



**SPORT WORKSTAND**

Easy to set up, this sturdy workstand holds your BMW securely in place, making maintenance easier to carry out.

For more detailed information, contact your BMW Motorrad dealership or go online at [www.bmw-motorrad.com](http://www.bmw-motorrad.com).

**PART NUMBERS**

**Sport workstand, front (image 1)**  
Order number: 77 02 8 551 859\*

**Sport workstand, rear (image 2)**  
Order number: 77 02 8 551 854\*

(+) HP workstand support (image 3)  
Order number: 77 25 8 560 293\*

**Rear workstand (image 4)**  
Order number: 77 02 8 549 415\*





### ORIGINAL BMW CARE PRODUCTS

Care set with a wide range of cleaning and care products in a 10l bucket with a lid.

Bucket content: Insect remover, motorbike cleaner, wheel rim cleaner, gloss polish, functional detergent, 3 Body & Bike shower gel samples (each 20 ml), sponge (130x105x40mm), microfibre cloth (40x40mm)

#### PART NUMBERS

##### Motorcycle care kit

Order number: 83 19 2 458 625\*

##### Motorcycle cleaner, 500 ml

Quickly removes dirt of any kind by coating and permeating the affected area then gently dissolving the dirt particles.

Order number: 83 19 2 408 157\*

##### Wheel rim cleaner, 500 ml

Effectively removes impurities like brake dust and dirt picked up from the street. The solution changes colour to indicate that it's working effectively.

Order number: 83 19 2 420 024\*

##### Insect remover, 500 ml

Intensive cleaning agent that effortlessly removes stubborn encrusted insect remains and bird droppings. Non-abrasive.

Order number: 83 19 2 420 028\*

##### Chain cleaner, 300 ml

Quickly and easily removes abrasive substances such as chain lubricant, sand and street dirt from the chain and chain wheel.

Order number: 83 19 2 420 027\*

##### Chain spray, 300 ml

A fully synthetic lubricant for drive chains on two-wheeled vehicles, and in particular for motorcycle chains with high rotational speed.

Order number: 83 19 2 408 163\*

##### Seat cleaner (for high-gloss faux leather), 50 ml

Cleans and maintains high-gloss faux leather seats and ensures they remain slip-free.

Order number: 83 19 2 420 026\*

##### Gloss polish, 250 ml

A special polish made of high-quality natural ingredients for restoring a deep shine.

Order number: 83 19 2 420 023\*

##### Metal polish, 75 ml

High-gloss polish and cleaner for aluminium, chrome, brass, nickel, stainless steel and other unpainted metals.

Order number: 83 19 2 420 025\*

##### Body + Bike shower gel, 250 ml

The first shower gel for rider and bike. Gently cleanses and nourishes the skin. Dermatologically tested. Also suitable for motorcycling cleaning.

Order number: 83 19 2 420 029\*

##### Cleaning cloth for helmet and visor

Wet and dry cloths for keeping your visor and helmet blemish-free. Ideal for removing dirt and insect remains while out on tour.

Order number: 83 19 2 420 022\*

##### Visor and helmet cleaner, 50 ml

A deep but gentle cleaning agent for removing dirt from the helmet and visor without leaving scratches or other blemishes.

Order number: 83 19 2 408 158\*

##### BMW anti-fogging spray, 50 ml

Uses anti-fogging additives to prevent the visor from misting up.

Order number: 83 19 2 408 159\*

##### Helmet pad cleaner, 300 ml

Cleaning foam that removes dirt and stains from upholstery and leaves it smelling fresh.

Order number: 83 19 2 408 160\*

##### Functional washing detergent, 250 ml

For high-quality BMW Motorrad clothing, outdoor apparel and sportswear, and microfibre fabrics. Especially suitable for suits with membrane technologies (as either laminate, liner or insert), which retain their water and wind-repellency and breathability even after multiple washes.

Order number: 83 19 2 408 161\*

##### Waterproofing agent for motorcycle clothing, 300 ml

Water and oil-repellent, for large fabric surfaces made out of natural and synthetic fibres. The agent wraps the fibre in an invisible, hydrophobic monomolecular film.

Order number: 83 19 2 408 162\*



### ORIGINAL BMW ADVANTEC ENGINE OIL

Designed exclusively for and tested by BMW, with high-performance BMW Motorrad bikes in mind, ADVANTEC Pro, ADVANTEC Ultimate and ADVANTEC Classic set the benchmark for lubricants. Observe versions in different countries.

For more detailed information, contact your BMW Motorrad dealership or go online at [bmw-motorrad.com](http://bmw-motorrad.com).

#### PART NUMBERS

**Original BMW ADVANTEC Classic engine oil 20W-50, 1l**

Order number: 83 21 2 450 004\*

**Original BMW ADVANTEC Pro engine oil 15W-50, 1l**

Order number: 83 21 2 444 515\*

**Original BMW ADVANTEC Pro engine oil 15W-50, 500 ml**

Order number: 83 21 2 455 133\*

**Original BMW ADVANTEC Ultimate engine oil 5W-40, 1l**

Order number: 83 21 2 444 514\*

**Original BMW ADVANTEC Ultimate engine oil 5W-40, 500 ml**

Order number: 83 21 2 455 132\*



\* Original BMW Motorrad equipment is available from your BMW Motorrad dealer.



# PREVIOUS MODELS

<b>C model range</b> _____	258
C 600 Sport, C 650 GT	
<b>G model range</b> _____	272
G 650 GS, G 650 GS Sertao	
<b>R model range</b> _____	280
R 1200 GS, R 1200 GS Adventure, R 1200 RT, R 1200 R, R 1200 ST, R 1200 S	
<b>F model range</b> _____	310
F 700 GS, F 800 S, F 800 ST, F 800 GT, F 650 GS, F 800 GS, F 800 R, F 800 GS Adventure	
<b>K model range</b> _____	336
K 1200 S, K 1300 S, K 1200 R, K 1200 R Sport, K 1300 R, K 1200 GT, K 1300 GT, K 1600 GT, K 1600 GTL, K 1600 GTL Exclusive	
<b>S model range</b> _____	358
HP4, S 1000 RR, S 1000 RR MÜ, S 1000 RR MÜ2, S 1000 R	



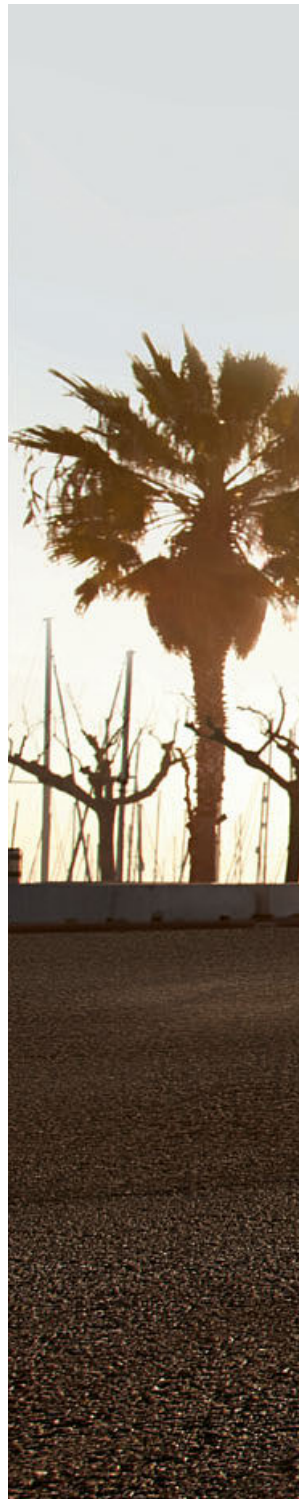

# C MODEL RANGE

## Vehicle-specific accessories for:

C 600 Sport  
Model code 0131, 0132

C 650 GT  
Model codes 0133, 0134

HP Parts	260
Storage	261
Design	263
Ergonomics & Comfort	265
Navigation	269
Safety	270



## HP PARTS



### HP SPORT SILENCER

#### AVAILABLE FOR

C600 Sport  
C650 GT

Made entirely out of titanium and stainless steel and to an exceptional level of craftsmanship, this slip-on silencer delivers a powerful rumble. It's also remarkably lightweight (1.5 kg lighter than standard version).

#### PART NUMBERS: C600 SPORT

**HP sport silencer**  
Order number: 77 11 8 544 341  
(+) ISA screw  
Order number: 71 29 9 070 80  
(+) Pressure disc  
Order number: 18 21 7 671 617  
(+) Spacer sleeve  
Order number: 18 21 7 672 806  
(+) Bracket  
Order number: 18 51 7 725 218  
(+) Grommet  
Order number: 18 21 7 677 791  
(+) Collar nut  
Order number: 71 19 9 060 89

#### PART NUMBERS: C650 GT

**HP sport silencer**  
Order number: 77 11 8 528 403  
(+) ISA screw  
Order number: 71 29 9 070 80  
(+) Pressure disc  
Order number: 18 21 7 671 617  
(+) Spacer sleeve  
Order number: 18 21 7 672 806  
(+) Bracket  
Order number: 18 51 7 725 218  
(+) Grommet  
Order number: 18 21 7 677 791  
(+) Collar nut  
Order number: 71 19 9 060 89

(+) = "and" – this item must be ordered at the same time  
(o) = "or" – this item may be ordered as an alternative option



## STORAGE



### TOP BOX

#### AVAILABLE FOR

C600 Sport  
C650 GT

The large, waterproof top box is available with lid trims in the same colour as the maxi-scooter itself. The optional backrest pad offers additional comfort for the pillion passenger.

Only available in conjunction with luggage grid. Top box and backrest for passenger cannot be fitted together. To be fitted and/or enabled in a specialist workshop, and ideally at your BMW Motorrad dealership.

#### PART NUMBERS: C600 SPORT

**Top box, 35l**  
Order number: 77 43 8 527 036  
(+) Locking cylinder according to vehicle identification number  
Order number: 77 44 8 542 498  
(+) Top box seal  
Order number: 77 43 8 527 233  
(+) Lid trim, left, Sapphire Black Metallic  
Order number: 77 43 8 523 976  
(+) Lid trim, right, Sapphire Black Metallic  
Order number: 77 43 8 523 982  
(o) Lid trim, left, Alpine White  
Order number: 51 25 7 688 957  
(o) Lid trim, right, Alpine White  
Order number: 77 43 8 537 800  
(o) Lid trim, left, Cosmic Blue Matt Metallic  
Order number: 77 43 8 523 977  
(o) Lid trim, right, Cosmic Blue Matt Metallic  
Order number: 77 43 8 523 983  
(o) Lid trim, left, Titanium Silver Metallic  
Order number: 77 43 8 523 978  
(o) Lid trim, right, Titanium Silver Metallic  
Order number: 77 43 8 523 984

#### PART NUMBERS: C650 GT

**Top box, 35l**  
Order number: 77 43 8 527 036  
(+) Locking cylinder according to vehicle identification number  
Order number: 77 44 8 542 498  
(+) Top box seal  
Order number: 77 43 8 527 233  
(o) Lid trim, left, Granite Grey Metallic  
Order number: 77 43 8 552 127  
(o) Lid trim, right, Granite Grey Metallic  
Order number: 77 43 8 552 128  
(o) Lid trim, left, Ebony Metallic  
Order number: 77 43 8 546 471  
(o) Lid trim, right, Ebony Metallic  
Order number: 77 43 8 546 472  
(o) Lid trim, left, Vermilion Red Metallic  
Order number: 77 43 8 537 803  
(o) Lid trim, right, Havana Metallic  
Order number: 77 43 8 537 804  
(o) Lid trim, left, Quartz Blue Metallic  
Order number: 77 43 8 537 801  
(o) Lid trim, right, Quartz Blue Metallic  
Order number: 77 43 8 537 802  
(o) Lid trim, left, Platinum Bronze Metallic  
Order number: 77 43 8 523 979  
(o) Lid trim, right, Platinum Bronze Metallic  
Order number: 77 43 8 523 985  
(o) Lid trim, left, Vermilion Red Metallic  
Order number: 77 43 8 523 980  
(o) Lid trim, right, Vermilion Red Metallic  
Order number: 77 43 8 523 986

\* Original BMW Motorrad equipment is available from your BMW Motorrad dealer.



### INNER BAG FOR TOP BOX

#### AVAILABLE FOR

C600 Sport  
C650 GT

The practical, rigid inner bag with waterproof main compartment keeps its contents well protected. The capacity of the top box is fully utilized, and loading and unloading can be accomplished quickly and easily.

#### PART NUMBER

**Inner bag for top box, 35l**  
Order number: 77 43 8 527 035



### BACKREST PAD FOR TOP BOX

#### AVAILABLE FOR

C600 Sport  
C650 GT

#### PART NUMBER

**Backrest pad for top box, 35l**  
Order number: 77 44 8 527 002



### PARTITION NET FOR LUGGAGE COMPARTMENT

#### AVAILABLE FOR

C600 Sport  
C650 GT

Divides the storage compartment below the seat into two sections when required, e.g. for transporting small items. It can be installed and removed quickly, and is easy to tuck away when not in use.

To be fitted and/or enabled in a specialist workshop, and ideally at your BMW Motorrad dealership.

#### PART NUMBERS: C600 SPORT

##### Partition net for luggage compartment

Order number: 77 49 8 527 033

(+) Blind rivet nut, flat head (four required)

Order number: 46 63 2 347 012

(+) Raised head screw (four required)

Order number: 63 27 6 579 66

#### PART NUMBERS: C650 GT

##### Partition net for luggage compartment

Order number: 77 49 8 527 034

#### PART NUMBER: C600 SPORT

##### Centre tunnel bag

Order number: 77 45 8 551 271

#### PART NUMBER: C650 GT

##### Centre tunnel bag

Order number: 77 45 8 527 014



### CENTRE TUNNEL BAG

#### AVAILABLE FOR

C600 Sport  
C650 GT

Fits the maxi-scooter perfectly, and offers a 12l capacity, waterproof main compartment. It has a detachable shoulder strap and a top pocket for small items. Can be attached and removed quickly and easily.

To be fitted and/or enabled in a specialist workshop, and ideally at your BMW Motorrad dealership.



### LUGGAGE GRID

#### AVAILABLE FOR

C600 Sport  
C650 GT

The sturdy, stylish luggage grid is ideal for securing the top box or other large items of luggage. Can be used while the backrest is fitted.

To be fitted and/or enabled in a specialist workshop, and ideally at your BMW Motorrad dealership.

For more detailed information, contact your BMW Motorrad dealership or go online at [bmw-motorrad.com](http://bmw-motorrad.com).

#### PART NUMBER: C600 SPORT

##### Luggage grid

Order number: 77 44 8 564 067

(+) Grab handle, left

Order number: 46 72 8 527 814

(+) Grab handle, right

Order number: 46 72 8 527 818

#### PART NUMBERS: C650 GT

##### Luggage grid

Order number: 77 44 8 566 025

(+) Metal frame insert kit (two required)

Order number: 77 44 8 555 129

(+) High-strength screw lock

Order number: 83 19 2 210 337

#### PART NUMBER: C650 GT

##### Luggage grid

Order number: 71 60 7 653 017

#### PART NUMBER: C650 GT

##### Luggage grid

Order number: 77 44 8 550 258

## DESIGN



### LED INDICATORS

#### AVAILABLE FOR

C600 Sport

Cutting-edge design inside and out. The LED indicators deliver reduced energy consumption and significantly longer bulb life – a shining example of efficiency.

To be fitted and/or enabled in a specialist workshop, and ideally at your BMW Motorrad dealership.

#### PART NUMBERS

##### LED indicator, front, left

Order number: 63 13 8 556 873

(+) Raised flange head screw (three required)

Order number: 06 32 7 651 212

##### LED indicator, front, right

Order number: 63 13 8 556 874

(+) Raised flange head screw (three required)

Order number: 06 32 7 651 212

##### LED indicators, rear (two required)

Order number: 63 13 8 522 499

(+) Hexagonal nut (two required)

Order number: 07 12 9 905 817

(+) Raised head screw (two required)

Order number: 11 11 7 653 180





### CHROME PARTS

#### AVAILABLE FOR

C600 Sport  
C650 GT

The chrome-plated footrest inserts and handlebar weights add a classy, personal touch to the maxi-scooter. To be fitted and/or enabled in a specialist workshop, and ideally at your BMW Motorrad dealership.

#### PART NUMBERS: C600 SPORT AND C650 GT

##### Chrome-plated handlebar weight

Order number: 63 13 8 556 873

(+) ISA screw (two required)

Order number: 7129907113

#### PART NUMBERS: C600 SPORT

##### Chrome-plated footrest insert, left

Order number: 77 25 8 527 057

(+) Countersunk screw (two required)

Order number: 07 14 7 152 962

##### Chrome-plated footrest insert, right

Order number: 77 25 8 527 058

(+) Countersunk screw (two required)

Order number: 07 14 7 152 962

##### Chrome-plated footrest insert, centre left

Order number: 77 25 8 527 059

It is not possible to combine the central chrome-plated footrest insert with crash pads.

(+) Countersunk screw (two required)

Order number: 07 14 7 152 962

##### Chrome-plated footrest insert, centre right

Order number: 77 25 8 527 060

It is not possible to combine the central chrome-plated footrest insert with crash pads.

(+) Countersunk screw (two required)

Order number: 07 14 7 152 962

##### Chrome-plated pillion foot peg, left

Order number: 77 25 8 527 303

(+) Bolts

Order number: 46 71 7 668 644

(+) Foot peg

Order number: 46 51 8 527 138

(+) Pressure spring

Order number: 46 71 7 664 148

(+) ISA screw

Order number: 07 12 9 905 122

(+) Pillion passenger foot peg locking plate

Order number: 46 71 8 527 079

(+) Locking clip

Order number: 07 11 9 901 545

(+) Ball

Order number: 07 11 9 905 155

##### Chrome-plated pillion foot peg, right

Order number: 77 25 8 527 304

(+) Bolts

Order number: 46 71 7 668 644

(+) Foot peg

Order number: 46 51 8 527 138

(+) Pressure spring

Order number: 46 71 7 664 148

(+) ISA screw

Order number: 07 12 9 905 122

(+) Pillion passenger foot peg locking plate

Order number: 46 71 8 527 079

(+) Locking clip

Order number: 07 11 9 901 545

(+) Ball

Order number: 07 11 9 905 155

#### PART NUMBERS: C650 GT

##### Chrome-plated footrest insert, left

Order number: 77 25 8 527 205

(+) Torx countersunk screw (two required)

Order number: 51 47 8 267 943

##### Chrome-plated footrest insert, right

Order number: 77 25 8 527 206

(+) Torx countersunk screw (two required)

Order number: 51 47 8 267 943

##### Chrome-plated footrest insert, rear left

Order number: 77 25 8 527 207

(+) Torx countersunk screw

Order number: 51 47 8 267 943

##### Chrome-plated footrest insert, rear right

Order number: 77 25 8 527 208

(+) Torx countersunk screw

Order number: 77 25 8 527 209

## ERGONOMICS & COMFORT



### SPORT WINDSHIELD

#### AVAILABLE FOR

C600 Sport

Gives the vehicle a sportier look (tinted version also available). With scratch-resistant coating for durability and unimpeded visibility.

To be fitted and/or enabled in a specialist workshop, and ideally at your BMW Motorrad dealership.

#### PART NUMBERS

##### Sport windshield, clear

Order number: 77 33 7 725 418

(+) Raised head screw (four required)

Order number: 06 32 7 651 211

##### Sport windshield, tinted

Order number: 77 33 7 725 419

(+) Raised head screw (four required)

Order number: 06 32 7 651 211



### TINTED WINDSHIELD

#### AVAILABLE FOR

C600 Sport

These wheels give the vehicle a sleek but strong look. With scratch-resistant coating for durability and unimpeded visibility.

To be fitted and/or enabled in a specialist workshop, and ideally at your BMW Motorrad dealership.

#### PART NUMBERS

##### Tinted windshield

Order number: 77 33 7 725 417

(+) Raised head screw (four required)

Order number: 06 32 7 651 211



### WIND DEFLECTORS

#### AVAILABLE FOR

C600 Sport

C650 GT

Effective wind protection for the rider's hands. The black plastic wind deflectors are securely attached to the fairing panels.

#### PART NUMBER: C600 SPORT

##### Wind deflectors

Order number: 77 31 8 527 005

#### PART NUMBER: C650 GT

##### Wind deflectors

Order number: 77 31 8 527 006



### SPORT SEAT

#### AVAILABLE FOR

C600 Sport

Instantly inviting, the sport seat features decorative stitching and is also available with seat heating, with separate settings for rider and passenger.

To be fitted and/or enabled in a specialist workshop, and ideally at your BMW Motorrad dealership.

#### PART NUMBERS

##### Sport seat, heated

Order number: 77 34 8 527 039

##### Sport seat, not heated

Order number: 52 53 8 552 099

(+) Buffer (four required)

Order number: 52 53 7 664 664

(+) Rubber element (two required)

Order number: 52 53 8 527 115

(+) Profile seal

Order number: 52 53 8 527 116



### LOW SEAT

#### AVAILABLE FOR

C600 Sport

C650 GT

20mm lower than the standard version, this low rider seat makes climbing on and handling easier.

To be fitted and/or enabled in a specialist workshop, and ideally at your BMW Motorrad dealership.



### COVER

#### AVAILABLE FOR

C600 Sport

C650 GT

Snug and waterproof yet breathable, this cover protects your maxi-scooter from rain, dirt and more. Made of tear-resistant, UV-resistant material.

#### PART NUMBER

##### Low seat

Order number: 77 8 527 017



#### PART NUMBER: C600 SPORT

##### Low seat

Order number: 52 53 8 546 268

#### PART NUMBER: C650 GT

##### Heated seat

Not available in conjunction with seat heating.

Order number: 52 53 7 725 454

(+) Buffer (four required)

Order number: 52 53 7 664 664

(+) Rubber element (two required)

Order number: 52 53 8 527 115

### HEATED SEAT

#### AVAILABLE FOR

C600 Sport

C650 GT

For a comfortable ride even in cooler weather: there are separate controls for the seat heating for both the driver and passenger.

To be fitted and/or enabled in a specialist workshop, and ideally at your BMW Motorrad dealership.

#### PART NUMBERS: C600 SPORT

##### Heated seat

Order number: 52 53 7 725 455

(+) Holding bracket

Order number: 07 14 9 139 223

(+) Adapter cable for seat heating

Order number: 61 12 8 525 432

(+) Multifunction switch, right

Order number: 61 31 8 546 172

(o) Multifunction switch, right

Order number: 61 31 8 546 174

#### PART NUMBERS: C650 GT

##### Heated seat

Order number: 77 43 8 566 126

(+) Holding bracket

Order number: 07 14 9 139 223

(+) Adapter cable for seat heating

Order number: 61 12 8 525 432

(+) Multifunction switch, right

Order number: 61 31 8 546 172

(o) Multifunction switch, right

Order number: 61 31 8 546 174



### RAIN COVER FOR SEAT

#### AVAILABLE FOR

C600 Sport

C650 GT

Snug, waterproof protective cover, secured under the seat with a rubber strap.

Packs down to small size, includes transport bag.



#### PART NUMBER: C600 SPORT

##### Rain cover for seat

Order number: 77 34 8 527 015

#### PART NUMBER: C650 GT

##### Rain cover for seat

Order number: 77 34 8 527 015

### EXCLUSIVE SEAT

#### AVAILABLE FOR

C650 GT

Instantly inviting, the Exclusive seat features decorative stitching and a high-quality look and feel. It's also available with seat heating, with separate settings for rider and passenger.

To be fitted and/or enabled in a specialist workshop, and ideally at your BMW Motorrad dealership.

#### PART NUMBER

##### Exclusive seat

Order number: 77 34 8 527 042



### SCOOTER LEG COVER

#### AVAILABLE FOR

C600 Sport

C650 GT

This waterproof protective cover is quick to attach and secure, keeping your favourite trousers safe from spray and also offering extra insulation against the cold when needed. Can be protected from unauthorized removal with the optional scooter lock.

To be fitted and/or enabled in a specialist workshop, and ideally at your BMW Motorrad dealership. Recommended maximum speed 130 km/h.



#### PART NUMBERS: C600 SPORT

##### Scooter leg cover

Order number: 77 31 8 527 011

(+) Plug-in nut (ten required)

Order number: 46 63 7 707 388

(+) Raised head screw (ten required)

Order number: 06 32 7 651 211

#### PART NUMBERS: C650 GT

##### Scooter leg cover

Order number: 77 31 8 527 012

(+) Plug-in nut (six required)

Order number: 46 63 7 707 388

(+) Raised head screw (six required)

Order number: 06 32 7 651 211



\* Original BMW Motorrad equipment is available from your BMW Motorrad dealer.

(+) = "and" – this item must be ordered at the same time

(o) = "or" – this item may be ordered as an alternative option



### HEATED GRIPS

#### AVAILABLE FOR

C600 Sport  
C650 GT

Keep your hands as warm as you like with three-level grip heating (available settings: 1, 2 or Auto based on outside temperature).

To be fitted and/or enabled in a specialist workshop, and ideally at your BMW Motorrad dealership.



#### PART NUMBERS

##### Heated grip, left

Order number: 61 31 7 721 851

##### Heated grip, right

Order number: 77 31 8 527 011

(+) Multifunction switch for heated grips, right

Order number: 61 31 8 567 704

(o) Multifunction switch for heated grips and seat heating, right

Order number: 61 31 8 567 708



### BACKREST FOR PASSENGER

#### AVAILABLE FOR

C600 Sport  
C650 GT

With padding and artificial leather in Black, the backrest delivers greater comfort for the passenger, and can be used in conjunction with the luggage grid (without top box).

Top box and backrest for passenger cannot be fitted together. To be fitted and/or enabled in a specialist workshop, and ideally at your BMW Motorrad dealership.

#### PART NUMBER: C600 SPORT

##### Backrest for passenger

Order number: 77 34 8 527 045

#### PART NUMBER: C650 GT

##### Backrest for passenger

Order number: 77 34 8 527 046



(+) = "and" – this item must be ordered at the same time  
(o) = "or" – this item may be ordered as an alternative option

## NAVIGATION

### BMW USB CHARGERS

#### AVAILABLE FOR

C600 Sport  
C650 GT

Used for charging compatible mobile phones while you're on the move.

#### PART NUMBERS

##### BMW USB charger

Order number: 65 41 2 166 411

##### BMW lightning USB adapter

Caution: Only for charging. No multimedia functions.

Order number: 61 12 2 354 478

##### BMW micro USB adapter

Caution: Only for charging. No multimedia functions.

Order number: 61 12 2 336 423

### BMW MOTORRAD NAVIGATION SYSTEMS

#### AVAILABLE FOR

C600 Sport  
C650 GT

Where am I? Where do I want to go, and what's the most scenic way to get there?

BMW Motorrad navigation devices show you where to go. Made specifically for motorcyclists, they're easy to fit and use – even with gloves on – and come with lifetime map updates.

The new BMW Motorrad Navigator VI is your ticket to the tour of your dreams. A whole new level of adventure awaits thanks to the "winding roads" route option, "avoid motorways" feature and the "round trip" function, which configures journeys based on time, distance or stopover. The circular polarization filter (CPOL) on the display minimizes reflection and improves contrast, ensuring the screen is easy to read, even in direct sunlight. 16 GB of flash storage, and the ability to stream music from your smartphone, are the ultimate luxury.

The BMW Motorrad Navigator V GPS system includes a 5" screen, 8 GB flash storage, Bluetooth® technology and optional smartphone link for real-time traffic updates. BMW Motorrad navigation devices and the BMW Motorrad smartphone cradle can only be mounted using the BMW Motorrad navigation device bracket.

For more detailed information, contact your BMW Motorrad dealership or go online at [bmw-motorrad.com](http://bmw-motorrad.com).

### BRACKET FOR BMW MOTORRAD NAVIGATION DEVICES

#### AVAILABLE FOR

C600 Sport  
C650 GT

Bracket for mounting BMW Motorrad navigation devices. Guarantees a good view of the navigation system.

#### PART NUMBERS

##### BMW Motorrad Navigator VI

(incl. 4-Button cradle mount)

Note differences in national-market specifications.

Order number: 77 52 8 355 749

##### BMW Motorrad Navigator VI

(incl. 4-Button cradle mount)

Note differences in national-market specifications.

Order number: 77 52 8 355 829

##### BMW Motorrad Navigator Street

Note differences in national-market specifications.

Order number: 77 52 8 557 855

##### BMW Motorrad Navigator Street

Note differences in national-market specifications.

Order number: 77 52 8 557 856



\* Original BMW Motorrad equipment is available from your BMW Motorrad dealer.



### BMW MOTORRAD SMARTPHONE CRADLE

#### AVAILABLE FOR

C600 Sport  
C650 GT

Now you can charge your phone out on the road with BMW Motorrad's waterproof smartphone cradle. Charging takes place wirelessly or via a plug-in connection. The display and navigation functions are perfectly positioned in your field of vision and can be easily operated from the cradle. For smartphones with 5" displays or smaller. Max. dimensions: 13.8 cm x 7.3 cm x 1.1 cm. Only in combination with bracket for BMW Motorrad navigation services.

#### PART NUMBERS

**BMW Motorrad smartphone cradle**  
Order number: 77 52 8 563 125

### ASPHERICAL MIRROR

#### AVAILABLE FOR

C650 GT

The curved surface of the aspherical mirror increases the range of vision, almost completely eliminating blind spots when correctly adjusted. To be fitted and/or enabled in a specialist workshop, and ideally at your BMW Motorrad dealership.

#### PART NUMBERS

**Aspherical mirror, left**  
Order number: 77 31 8 527 285  
**Aspherical mirror, right**  
Order number: 77 31 8 527 286

(+) = "and" – this item must be ordered at the same time  
(o) = "or" – this item may be ordered as an alternative option

### ANTI-THEFT ALARM SYSTEM WITH REMOTE CONTROL (NOT SHOWN)

#### AVAILABLE FOR

C600 Sport  
C650 GT

Note differences in national-market specifications. To be fitted and/or enabled in a specialist workshop, and ideally at your BMW Motorrad dealership.

#### PART NUMBERS

**Anti-theft alarm system with remote control**  
Order number: 77 53 8 545 003  
(+) Anti-theft alarm system bracket  
Order number: 77 53 8 527 136  
(+) Clip nut (two required)  
Order number: 51 12 7 070 202  
(+) Raised head screw (four required)  
Order number: 06 32 7 651 204  
(+) ISA screw  
Order number: 71 29 9 060 88  
(+) Resistor  
Order number: 61 13 7 668 405  
(+) Battery  
Order number: 65 75 2 337 504



### CRASH PADS

#### AVAILABLE FOR

C600 Sport  
C650 GT

Crash pads protect the fairing from damage in the event of a fall. To be fitted and/or enabled in a specialist workshop, and ideally at your BMW Motorrad dealership. It is not possible to combine the central chrome-plated footrest insert with crash pads.

#### PART NUMBER: C600 SPORT

**Crash pads**  
Order number: 77 03 8 527 003

#### PART NUMBER: C650 GT

**Crash pads**  
Order number: 77 03 8 527 004



### SCOOTER LOCK

#### AVAILABLE FOR

C600 Sport  
C650 GT

The scooter lock ensures that your maxi-scooter stays right where you left it. For example, the end of the handlebars can be secured using the swing arm or an immovable object.

#### PART NUMBERS

**Scooter lock**  
Order number: 77 25 8 527 047  
(+) ISA screw  
Order number: 07 12 9 906 088

## SAFETY

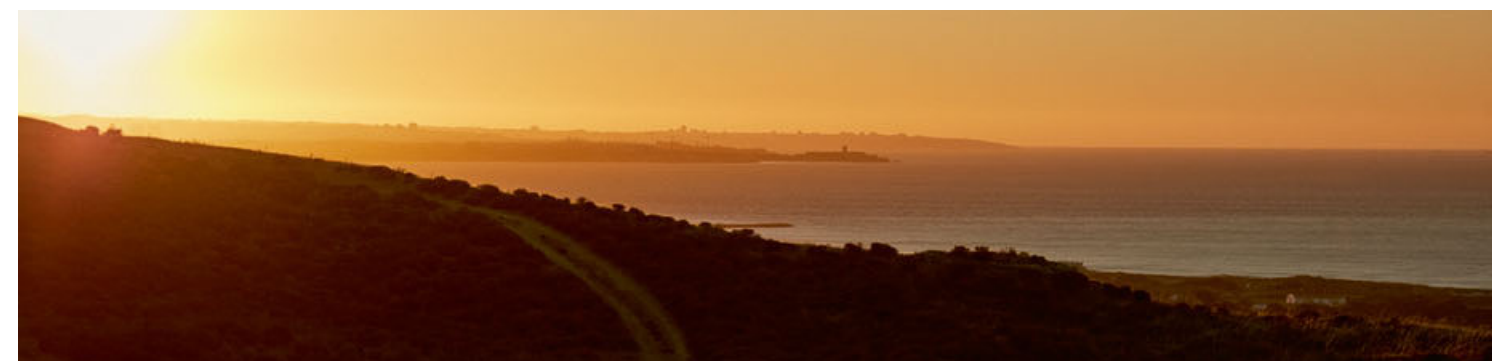

\* Original BMW Motorrad equipment is available from your BMW Motorrad dealer.



# ***G MODEL RANGE***

## **Vehicle-specific accessories for:**

G 650 GS  
Model code 0178, 0179, 0180, 0188, 0189

G 650 GS Sertao  
Model code 0136, 0146

**Storage** ————— 274

**Ergonomics & Comfort** ————— 276

**Safety** ————— 278



## STORAGE



### VARIABLE PANNIERS

#### AVAILABLE FOR

G 650 GS  
G 650 GS Sertao

Splash-proof plastic panniers with adjustable capacity. The pannier is narrower when capacity is reduced, which is useful in city traffic. The capacity on both sides is 19 to 28l.

#### PART NUMBERS

##### Variable pannier, left

Order number: 77 41 7 723 467\*

(+) Locking cylinder with code

Order number: 51 25 2 313 283\*

##### Variable pannier, right

Order number: 77 41 7 723 468\*

(+) Locking cylinder with code

Order number: 51 25 2 313 283\*



### INNER BAG FOR TOP BOX

#### AVAILABLE FOR

G 650 GS  
G 650 GS Sertao

A highly water-resistant, easy-to-pack inner bag that you can use to carry luggage to and from your motorcycle. This eliminates the need to remove the top box.

#### PART NUMBERS

##### Inner bag for top box

Order number: 71 60 7 687 612\*



### PANNIER HOLDERS

#### AVAILABLE FOR

G 650 GS  
G 650 GS Sertao

To be fitted and/or enabled in a specialist workshop, and ideally at your BMW Motorrad dealership.

#### PART NUMBERS

##### Pannier racks

Order number: 77 42 8 534 411\*



### TANK BAG, 13-17L

#### AVAILABLE FOR

G 650 GS  
G 650 GS Sertao

The tankbag is shaped for a snug fit on the motorcycle and has a waterproof main compartment. The map compartment and exterior pocket are highly water-resistant. An all-round zip increases capacity from 13l to 17l.

#### PART NUMBERS

##### Tank bag, 13-17l

Order number: 77 45 7 724 681\*

### TOP BOX, 31L

#### AVAILABLE FOR

G 650 GS  
G 650 GS Sertao

The top box attaches quickly and easily to the standard luggage grid. There's even space for a helmet inside.

#### PART NUMBERS

##### Top box, 31l

Order number: 71 60 7 710 982\*

(+) Top box locks set

Order number: 51 25 7 660 863\*



### INNER BAG FOR VARIABLE PANNIERS

#### AVAILABLE FOR

G 650 GS  
G 650 GS Sertao

The practical, waterproof inner bag with removable carry strap keeps its contents well protected. Variable panniers, left and right (can be used on both sides).

#### PART NUMBERS

##### Inner bag for variable panniers

Order number: 71 60 7 687 610\*



(+) = "and" – this item must be ordered at the same time  
(o) = "or" – this item may be ordered as an alternative option



\* Original BMW Motorrad equipment is available from your BMW Motorrad dealer.

## ERGONOMICS AND COMFORT



### HIGH WINDSHIELD

#### AVAILABLE FOR

G 650 GS  
G 650 GS Sertao

Improves protection against wind and rain, especially on longer journeys. Tinted version also available.

#### PART NUMBERS

##### High windshield

Order number: 46 63 7 724 644\*

(+) Grommet (four required)

Order number: 46 63 8 555 101\*

(+) Collar bushing, steel (four required)

Order number: 46 63 7 724 481\*

(+) Raised head screw (four required)

Order number: 63 13 7 655 661\*

##### High windshield, tinted

Order number: 77 33 7 724 637\*

(+) Grommet (four required)

Order number: 46 63 8 555 101\*

(+) Collar bushing, steel (four required)

Order number: 46 63 7 724 481\*

(+) Raised head screw (four required)

Order number: 63 13 7 655 661\*



### CENTRE STAND

#### AVAILABLE FOR

G 650 GS

The centre stand makes refuelling easier and ensures your motorcycle takes up less parking space.

#### PART NUMBERS

##### Centre stand

Order number: 46 52 7 669 895\*

(+) Tension spring (two required)

Order number: 46 52 7 650 721\*

(+) Torx screw (two required)

Order number: 07 12 9 904 984\*

(+) Bushing (two required)

Order number: 46 52 7 652 164\*

(+) Washer (two required)

Order number: 07 11 9 904 198\*

(+) Hexagonal nut (two required)

Order number: 07 12 9 904 879\*

**Centre stand** (only available in conjunction with lowered suspension option.)

Order number: 46 52 7 686 769\*

(+) Tension spring (two required)

Order number: 46 52 7 650 721\*

(+) Torx screw (two required)

Order number: 07 12 9 904 984\*

(+) Bushing (two required)

Order number: 46 52 7 652 164\*

(+) Washer (two required)

Order number: 07 11 9 904 198\*

(+) Hexagonal nut (two required)

Order number: 07 12 9 904 879\*

### LOW WINDSHIELD, TINTED

#### AVAILABLE FOR

G 650 GS  
G 650 GS Sertao  
Gives the vehicle a sportier look.

#### PART NUMBERS

##### Low windshield, tinted

Order number: 77 33 7 723 689\*

(+) Grommet (four required)

Order number: 46 63 8 555 101\*

(+) Collar bushing, steel (four required)

Order number: 46 63 7 724 481\*

(+) Raised head screw (four required)

Order number: 63 13 7 655 661\*



### SINGLE SEAT WITH LUGGAGE COMPARTMENT

#### AVAILABLE FOR

G 650 GS  
G 650 GS Sertao

The single seat in Black provides an additional storage compartment in place of the pillion seat – a handy place to keep tools and other small items.

#### PART NUMBERS

##### Single seat with luggage compartment

Order number: 71 60 7 653 837\*

(+) Locking cylinder with code

Order number: 51 25 2 313 285\*

(+) Individual seat mounting kit

Order number: 71 60 7 688 805\*

(+) Cap

Order number: 71 60 7 664 993\*

(+) Cover gasket

Order number: 71 60 7 667 947\*

### HEATED GRIPS

#### AVAILABLE FOR

G 650 GS  
G 650 GS Sertao

#### PART NUMBERS

##### Heated grip, left

Order number: 61 31 7 728 861\*

(+) Switch for heated grip

Order number: 61 31 7 714 486\*

##### Heated grip, right

Order number: 61 31 7 728 862\*

### HIGH SEAT

#### AVAILABLE FOR

G 650 GS  
G 650 GS Sertao  
40 mm higher than the standard version, this padded seat provides a more comfortable seating position for taller riders.

#### PART NUMBERS

##### High seat

Order number: 52 53 2 345 735\*



(+) = "and" – this item must be ordered at the same time  
(o) = "or" – this item may be ordered as an alternative option

\* Original BMW Motorrad equipment is available from your BMW Motorrad dealer.

## SAFETY



### ALUMINIUM BASH PLATE

#### AVAILABLE FOR

G 650 GS  
G 650 GS Sertao

Protects engine from stone impacts and ground strikes during light off-road use. Does not restrict banking angle or movement of feet, etc.

#### PART NUMBERS

##### Aluminium bash plate

Order number: 51 47 7 655 605\*

(+) Aluminium bash plate mounting kit  
Order number: 77 41 7 723 472\*



### ENGINE PROTECTION BAR

#### AVAILABLE FOR

G 650 GS  
G 650 GS Sertao

In situations where impacts are unavoidable, the engine protection bar effectively helps prevent damage. Only available in conjunction with aluminium bash plate.

#### PART NUMBERS

##### Engine protection bar

Order number: 71 60 7 653 858\*

### HAND PROTECTORS

#### AVAILABLE FOR

G 650 GS  
G 650 GS Sertao

For effective protection against low branches and flying stones. Also helps shield the rider from wind in cold weather.

#### PART NUMBERS

##### Hand protectors

Order number: 77 32 8 526 930\*



(+) = "and" – this item must be ordered at the same time  
(o) = "or" – this item may be ordered as an alternative option



\* Original BMW Motorrad equipment is available from your BMW Motorrad dealer.

# R MODEL RANGE

## Vehicle-specific accessories for:

R 1200 R  
Model code 0378, 0398, 0400, 0490

R 1200 RT  
Model code 0368, 0388, 0430, 0440

R 1200 S  
Model code 0366, 0396

R 1200 ST  
Model code 0328, 0338

R 1200 GS  
Model code 0307, 0317, 0303, 0313, 0450, 0460

R 1200 GS Adventure  
Model code 0382, 0397, 0380, 0390, 0470, 0480

HP Parts ————— 282

Storage ————— 285

Design ————— 293

Ergonomics & Comfort ————— 298

Navigation ————— 303

Safety ————— 305



## HP PARTS



### HP SPORT SILENCER

#### AVAILABLE FOR

R 1200 R  
R 1200 RT  
R 1200 S  
R 1200 ST  
R 1200 GS  
R 1200 GS Adventure

Made entirely out of titanium, this slip-on silencer delivers a powerful rumble. It's also remarkably lightweight.

#### PART NUMBER: R 1200 R

**HP sport silencer** (image 1)  
Order number: 77 11 8 520 328\*  
Only for model codes 0400, 0490

#### PART NUMBERS: R 1200 RT

**HP sport silencer** (image 2)  
Order number: 71 60 7 720 225  
Only for model codes 0430, 0440

**HP sport silencer** (image 2)  
Order number: 71 60 7 714 260  
Only for model codes 0368, 0388

#### PART NUMBERS: R 1200 ST

**HP sport silencer** (image 2)  
Order number: 71 60 7 714 260  
Only for model codes 0368, 0388

#### PART NUMBER: R 1200 S

**HP sport silencer** (image 3)  
Order number: 71 60 7 704 076

#### PART NUMBERS: R 1200 GS, R 1200 GS ADVENTURE

**HP sport silencer** (image 4)  
Order number: 77 11 7 723 826  
Only for model codes 0450, 0460 (GS) & 0470, 0480 (GS Adv.)

(+) = "and" – this item must be ordered at the same time  
(o) = "or" – this item may be ordered as an alternative option



### HP CARBON CYLINDER HEAD COVER

#### AVAILABLE FOR

R 1200 R  
Only for model codes 0378, 0398  
R 1200 RT  
Only for model codes 0368, 0388  
R 1200 S  
R 1200 ST  
R 1200 GS  
Only for model codes 0303, 0307, 0313, 0317  
R 1200 GS Adventure  
Only for model codes 0380, 0382, 0390, 0397

The HP carbon cylinder head covers score big in the looks department, thanks to a high-quality material and finish, and it also helps reduce the overall weight of the bike.

To be fitted and/or enabled in a specialist workshop, and ideally at your BMW Motorrad dealership.

Not available in conjunction with aluminium/plastic cylinder head cover guard.

#### PART NUMBERS

##### HP carbon cylinder head cover, left

Order number: 71 60 7 709 405\*

(+) HP carbon cylinder head cover, right

Order number: 71 60 7 711 813\*

#### ALSO FOR R 1200 S, R 1200 ST

(+) Screw with bushing (four required)

Order number: 11 12 7 680 077\*

(+) Round nut (for required)

Order number: 11 14 7 675 699\*

\* Original BMW Motorrad equipment is available from your BMW Motorrad dealer.



### HP CARBON BELT COVER

#### AVAILABLE FOR

R 1200 R  
R 1200 S  
R 1200 ST  
R 1200 GS  
R 1200 GS Adventure

The HP carbon belt cover is a more stylish alternative to the standard plastic cover – and it weighs less too.

To be fitted and/or enabled in a specialist workshop, and ideally at your BMW Motorrad dealership.

#### PART NUMBER

##### HP carbon belt cover

Order number: 71 60 7 709 611\*

### HP CARBON HEAT SHIELD TRIM (NOT SHOWN)

#### AVAILABLE FOR

R 1200 GS  
R 1200 GS Adventure

The HP carbon heat shield trim for the join between the silencer and the exhaust-manifold replaces the standard aluminium trim and is suitable for both the standard and HP sport silencers.



### HP MILLED HAND LEVER

#### AVAILABLE FOR

R 1200 R  
R 1200 S  
R 1200 GS  
R 1200 GS Adventure

The high-quality CNC-milled clutch and brake levers switch easily between four settings via an adjusting bolt. They're a great way to personalize your bike, and a stylish ever-present in your primary field of view.

To be fitted and/or enabled in a specialist workshop, and ideally at your BMW Motorrad dealership.

#### PART NUMBER

##### HP milled hand lever

(two required, left + right identical)

Order number: 71 60 7 706 739\*

#### PART NUMBER

##### HP carbon heat shield trim

Order number: 77 11 7 724 655\*



### HP FORGED WHEELS

**AVAILABLE FOR**  
R 1200 R  
R 1200 S

Thanks to the use of lightweight-construction techniques, the HP forged wheels are approx. 1.1 kg lighter (per set) than the standard wheels. Reducing the unsprung and rotating mass improves handling and the quality of the suspension.

To be fitted and/or enabled in a specialist workshop, and ideally at your BMW Motorrad dealership.

#### PART NUMBERS: R 1200 R, R 1200 S

##### HP forged wheel, front

Order number: 71 60 7 715 801\*

(+) Quick-release axle

Order number: 36 31 8 526 446\*

(+) Bushing

Order number: 36 31 7 664 722\*

(+) Screw plug, inner hexagon

Order number: 07 11 9 905 146\*

(+) Valve

Order number: 36 31 7 653 064\*

Not required for vehicles with TPC

(+) Valve insert

Order number: 36 31 7 683 236\*

Not required for vehicles with TPC

(+) Sensor with valve

Order number: 36 31 8 532 731\*

Not required for vehicles with TPC

(+) TPC valve repair kit

Order number: 36 31 8 520 871\*

Not required for vehicles with TPC

#### ALSO FOR R 1200 R

(+) HP forged wheel, rear

Order number: 71 60 7 709 396\*

#### ALSO FOR R 1200 S

(+) HP forged wheel, rear

Order number: 71 60 7 709 397\*



### HP INSTRUMENT CLUSTER

**AVAILABLE FOR**  
R 1200 S

The all-weather HP instrument cluster combines the classic BMW display with a host of racetrack-inspired features – a dream addition for all motorsport enthusiasts.

To be fitted and/or enabled in a specialist workshop, and ideally at your BMW Motorrad dealership.

#### PART NUMBERS

##### HP instrument cluster

Order number: 62 11 7 719 732\*

(+) HP instrument cluster fixing parts

Order number: 71 60 7 715 840\*

(+) Cable harness for instrument cluster

Order number: 71 60 7 723 833\*

(+) Auxiliary switch for Set/Menu

Order number: 71 60 7 707 844\*

(+) ISA screw (two required)

Order number: 32 72 7 705 874\*



### HP LAP TIMER

**AVAILABLE FOR**  
R 1200 S

For automatic logging of lap times on the racetrack, with precise breakdowns of individual laps.

Only for track use (not homologated for road use).

Only available in conjunction with HP instrument cluster.

#### PART NUMBERS

(+) **HP infrared transmitter for lap timer**

Order number: 71 60 7 715 836\*

**HP infrared receiver for lap timer**

Order number: 71 60 7 715 830\*



(+) = "and" – this item must be ordered at the same time  
(o) = "or" – this item may be ordered as an alternative option

## STORAGE



### INNER BAGS FOR VARIABLE PANNIERS AND VARIABLE TOP BOX

**AVAILABLE FOR**  
R 1200 GS

The practical, waterproof inner bag with removable carry strap keeps its contents well protected. As with the variable pannier, its capacity is adjustable.

#### PART NUMBERS

**Inner bag for variable pannier, left**

Order number: 71 60 7 687 610\*

**Inner bag for variable pannier, right and variable top box**

Order number: 71 60 7 687 611\*



### VARIABLE PANNIERS

**AVAILABLE FOR**  
R 1200 GS

The variable panniers are fitted with a patented adjustment system, allowing the capacity to be reduced from 68 l (29 l left, 39 l right) to 50 l (20 l left, 30 l right). The pannier is 120 mm narrower when capacity is reduced, which is useful in city traffic.

#### PART NUMBERS

**Variable pannier, left**

Order number: 71 60 7 692 173\*

**Variable pannier, right**

Order number: 71 60 7 670 828\*

(+) Repair kit for locking cylinder (four required)

Order number: 51 25 7 698 202\*



### PANNIER RACKS FOR VARIABLE PANNIERS

**AVAILABLE FOR**  
R 1200 GS

The pannier rack (for mounting variable panniers) fits effortlessly into the overall design of the bike. Thanks to its high-quality Silver paint finish, it also won't look out of place when no panniers are mounted.

#### PART NUMBERS

**Pannier racks for variable panniers**

Order number: 46 54 7 695 986\*

(+) 2x raised head screw

Order number: 46 54 7 705 577\*

\* Original BMW Motorrad equipment is available from your BMW Motorrad dealer.



### VARIABLE TOP BOX

**AVAILABLE FOR**  
R 1200 GS

Like the panniers, the top box is fitted with a patented adjustment system, which increases capacity from 25 l to 35 l. The variable top box can also be mounted in the place of the pillion seat (for improved weight distribution, closer to the centre of gravity). In this case, the luggage grid must also be removed, and a mounting kit is required for the top box.



### ATTACHMENT FOR TOP BOX (TO REPLACE PILLION SEAT)

**AVAILABLE FOR**  
R 1200 GS

**PART NUMBERS**

**Attachment for top box (to replace pillion seat)**

Order number: 46 54 7 688 336\*

(+) Adapter plate

Order number: 71 60 7 707 240\*



### ALUMINIUM PANNIERS

**AVAILABLE FOR**  
R 1200 GS Adventure

Suitable for off-road use, these sturdy aluminium panniers have a generous capacity of approx. 82 l (38 l left, 44 l right).

**PART NUMBER**

**Aluminium pannier, left**

Order number: 71 60 7 722 305\*

**Aluminium pannier, right**

Order number: 71 60 7 722 306\*

(+) Repair kit for locking cylinder (three required per pannier)

Order number: 51 25 7 698 202\*



### INNER BAG FOR ALUMINIUM PANNIERS

**AVAILABLE FOR**  
R 1200 GS Adventure

High-quality materials and a robust design make the watertight inner bag suitable for use both in and on top of aluminium panniers.

**PART NUMBERS**

**Inner bag for aluminium pannier, left**  
Order number: 71 60 7 699 055\* (image 1)

**Inner bag for aluminium pannier, right**  
Order number: 71 60 7 699 056\* (image 2)



### ALUMINIUM TOP BOX

**AVAILABLE FOR**  
R 1200 GS Adventure

**PART NUMBER**

**Aluminium top box**  
Order number: 71 60 7 722 309\*

(+) Locking cylinder according to vehicle identification number

Order number: 51 25 7 687 199\*

### BACKREST PAD FOR VARIABLE TOP BOX

**AVAILABLE FOR**  
R 1200 GS

**PART NUMBERS**

**Variable top box**

Order number: 77 43 8 527 849\*

(+) Locking cylinder according to vehicle identification number

Order number: 51 25 7 681 199\*

### CARRY HANDLE FOR ALUMINIUM PANNIER OR TOP BOX

**AVAILABLE FOR**  
R 1200 GS Adventure

**PART NUMBER**

**Carry handle for aluminium pannier or top box**

Order number: 77 49 8 543 224\*

### TOP BOX RACK FOR ALUMINIUM TOP BOX

**AVAILABLE FOR**  
R 1200 GS Adventure

**PART NUMBERS**

**Rack for aluminium top box**

Order number: 71 60 7 694 181\*

(+) Top box mounting kit

Order number: 71 60 7 696 177\*

### BACKREST PAD FOR ALUMINIUM TOP BOX

**AVAILABLE FOR**  
R 1200 GS Adventure

**PART NUMBER**

**Backrest pad for aluminium top box**

Order number: 77 44 8 546 808\*

### INNER BAG FOR ALUMINIUM TOP BOX

**AVAILABLE FOR**  
R 1200 GS Adventure

**PART NUMBER**

**Inner bag for aluminium top box**

Order number: 71 60 7 699 057\*

### TOP BOX HOLDER FOR VARIABLE TOP BOX (NOT SHOWN)

**AVAILABLE FOR**  
R 1200 GS

**PART NUMBER**

**Variable top box rack**

Order number: 71 60 7 707 239\*



(+) = "and" – this item must be ordered at the same time  
(o) = "or" – this item may be ordered as an alternative option

\* Original BMW Motorrad equipment is available from your BMW Motorrad dealer.





### TOP BOX, 28 L

**AVAILABLE FOR**  
R 1200 R  
R 1200 RT  
R 1200 ST

The waterproof top box is easy to mount on the luggage grid and has enough space inside for a helmet.

#### PART NUMBERS

##### Top box, 28 l

Order number: 77 43 7 724 352\*

(+) Locking cylinder according to vehicle identification number

Order number: 51 25 7 681 200\*

(+) Abrasion protector set

Order number: 71 60 7 694 163\*



### BACKREST PAD FOR TOP BOX, 28 l

**AVAILABLE FOR**  
R 1200 R  
R 1200 RT  
R 1200 ST

#### PART NUMBER

##### Backrest pad for top box (28 l)

Order number: 71 60 7 692 672\*



### PANNIER RACKS FOR SYSTEM PANNIERS

**AVAILABLE FOR**  
R 1200 R

#### PART NUMBER

##### Pannier racks for system panniers

Order number: 71 60 7 700 008



### INNER BAG FOR SYSTEM PANNIER

**AVAILABLE FOR**  
R 1200 R  
R 1200 RT  
R 1200 ST

These inner bags are a perfect fit, both sturdy and lightweight. Handy compartments for small items and carry handles that can be tucked away make them essential travel companions. Left and right are identical

#### PART NUMBER

##### Inner bag for system pannier

Order number: 71 60 7 680 543\*



### IMPACT PROTECTION SYSTEM FOR SYSTEM PANNIER

**AVAILABLE FOR**  
R 1200 R  
R 1200 RT  
R 1200 ST

Protects lower area of panniers against scratching.

#### PART NUMBERS

##### Impact protection system for system pannier, left

Order number: 71 60 7 693 675\*

(+) Impact protection system for system pannier, right

Order number: 71 60 7 693 676\*

### INNER BAG FOR TOP BOX, 28 L

**AVAILABLE FOR**  
R 1200 R  
R 1200 RT  
R 1200 ST

Slipping seamlessly into the overall design of the bike, these inner bags are both sturdy and lightweight. Handy compartments for small items and carry handles that can be tucked away make them essential travel companions.

#### PART NUMBERS

##### Inner bag for top box, 28 l

Order number: 71 60 7 680 541\*



### SYSTEM PANNIERS

**AVAILABLE FOR**  
R 1200 R  
R 1200 RT

The sleek design of the watertight system panniers blends in effortlessly with the overall profile of the bike. Each pannier has a capacity of approx. 32 l.

#### PART NUMBERS

##### System pannier, left

Order number: 77 41 7 727 089\*

##### (+) System pannier, right

Order number: 71 60 7 720 288\*

(+) Locking cylinder according to vehicle identification number

Order number: 51 25 7 681 200\*

(+) 2x gold reflectors

Order number: 63 14 7 671 350\*

(+) 2x badge label

Order number: 46 54 7 706 271\*

(+) Pannier heat shield retrofit kit

Order number: 77 42 7 729 294\*

### PROTECTIVE FILM FOR TOP OF SYSTEM PANNIERS

**AVAILABLE FOR**  
R 1200 RT

Self-adhesive, protects pannier paintwork.

#### PART NUMBER

##### Protective film for top of system panniers

Order number: 71 60 7 714 329\*





**LARGE PANNIER RACK INCL. LUGGAGE GRID**

**AVAILABLE FOR**  
R 1200 R

**PART NUMBERS**

**Large pannier rack incl. luggage grid**  
Order number: 77 44 8 521 412\*  
(+) Rear fairing panel, centre  
Order number: 46 63 7 723 861\*



**LUGGAGE GRID**

**AVAILABLE FOR**  
R 1200 ST

**PART NUMBER**

**Luggage grid**  
Order number: 71 60 7 694 424\*



**SPORT PANNIERS**

**AVAILABLE FOR**  
R 1200 S

Splash-proof sport panniers come with waterproof inner bags (one per pannier). Capacity is adjustable from 15 to 25l on each side – ample room for a helmet in each pannier.

**PART NUMBERS**

**Sport pannier, left**  
Order number: 71 60 7 723 513\*  
**Sport pannier, right**  
Order number: 71 60 7 723 514\*  
(+) Mounting kit  
Order number: 71 60 7 680 840\*  
(+) Locking cylinder according to vehicle identification number  
Order number: 51 25 7 681 200\*

**PANNIER RACKS FOR SPORT PANNIERS (NOT SHOWN)**

**AVAILABLE FOR**  
R 1200 S

**PART NUMBER**

**Pannier racks for sport panniers**  
Order number: 71 60 7 699 072\*



**TANKBAG**

**AVAILABLE FOR**  
R 1200 R

Along with a waterproof main compartment and A4 map pocket, this tankbag has a zipped compartment for small items in the lid and a patch pocket for keys, glasses case, etc. An all-round zip increases capacity from 13l to 21l. Cannot be used when BMW Motorrad Navigator is fitted.

**PART NUMBER**

**Tankbag**  
Order number: 71 60 7 695 236\*

**TANKBAG**

**AVAILABLE FOR**  
R 1200 GS.  
Only for model codes 0307, 0317  
R 1200 GS Adventure

The tank bag with a large waterproof main compartment (capacity approx. 22 l), A4 map pocket and a detachable hip bag.

**PART NUMBER**

**Tankbag**  
Order number: 71 60 7 709 149\*



**LARGE TANKBAG**

**AVAILABLE FOR**  
R 1200 GS  
Only for model codes 0303, 0313, 0450, 0460

The large tankbag with waterproof main compartment also comes with a detachable hip bag with length-adjustable carry strap. The A4 map pocket has a preformed shelf insert for mobile phones and other small items. Not available in conjunction with handlebar cross-brace.

**PART NUMBER**

**Large tankbag**  
Order number: 71 60 7 713 014\*



**TANKBAG**

**AVAILABLE FOR**  
R 1200 RT

The tankbag with waterproof main compartment and A4 map pocket attaches quickly and easily to the motorcycle via "easy-click-on" technology with locking latch. An all-round zip increases capacity from 13l to 20l.

**PART NUMBER**

**Tankbag**  
Order number: 71 60 7 706 363\*

**SMALL TANKBAG (NOT SHOWN)**

**AVAILABLE FOR**  
R 1200 GS  
Only for model codes 0303, 0313, 0450, 0460

This tankbag for smaller items of luggage has a waterproof main compartment. The A4 map pocket has a preformed shelf insert for mobile phones and other small items.

**PART NUMBER**

**Small tankbag**  
Order number: 71 60 7 713 012\*

**INNER BAG FOR TOP BOX, 49 L**

**AVAILABLE FOR**  
R 1200 RT

Slipping seamlessly into the overall design of the bike, these inner bags are both sturdy and lightweight. Handy compartments for small items and carry handles that can be tucked away make them essential travel companions.

**PART NUMBER**

**Inner bag for top box, 49 l**  
Order number: 71 60 7 680 542\*



**LARGE TOP BOX**

**AVAILABLE FOR**  
R 1200 RT

The waterproof top box is easy to mount on the luggage grid and has enough space inside for up to two helmets.

**PART NUMBERS**

**Large top box, White Aluminium, 49 l**  
Order number: 71 60 7 720 456\*  
**(o) Large top box, Sapphire Black, 49 l**  
(not shown)  
Order number: 71 60 7 720 503\*  
(+) Locking cylinder according to vehicle identification number  
Order number: 51 25 7 681 200\*





### TANKBAG

**AVAILABLE FOR**  
R 1200 ST

The tankbag with (approx.) 13-l waterproof main compartment, adjustable to approx. 20 l via an all-round zip, and an A4 map pocket. Cannot be used when BMW Motorrad Navigator is fitted.

**PART NUMBER**

**Tankbag**  
Order number: 71 60 7 691 517\*



### TANKBAG

**AVAILABLE FOR**  
R 1200 ST

This tankbag has a large waterproof main compartment (approx. 12 l) and a pocket (with window) for smaller items. It fits various BMW Motorrad models and can be combined with BMW Motorrad Navigator systems.

**PART NUMBERS**

**Tankbag**  
Order number: 71 60 7 691 391\*  
(+) Tankbag mounting kit  
Order number: 71 60 7 680 838\*



### TANKBAG

**AVAILABLE FOR**  
R 1200 S

Waterproof tank bag with (approx.) 17-l main compartment, adjustable to approx. 25 l via an all-round zip, and an A4 map pocket.

**PART NUMBER**

**Tankbag**  
Order number: 71 60 7 695 233\*

### UNIVERSAL TANKBAG

**AVAILABLE FOR**  
R 1200 R

The tankbag with a waterproof main compartment with a small map pocket. Fits various BMW Motorrad models. Capacity expands from approx. 10 l to 12 l. Can be combined with BMW Motorrad Navigator systems.

**PART NUMBERS**

**Universal tankbag**  
Order number: 77 49 7 726 994\*  
(+) Universal tankbag attachment  
Order number: 77 49 7 727 287\*



### ATACAMA SOFT LUGGAGE SYSTEM

**AVAILABLE FOR**  
R 1200 GS Adventure

The waterproof soft luggage system for on-road and off-road rides consists of a 35 l side bag, a 25 l side bag and a luggage roll. The luggage roll has a practical rucksack function and is therefore also ideal for Fly and Ride Trips. Only available in conjunction with pannier mountings for aluminium panniers.

**PART NUMBER**

**Atacama side bags set**  
Order number: 77 40 2 451 375\*  
**Atacama luggage roll, 40 litres**  
Order number: 77 40 2 451 381\*  
(+) Adapter for Atacama side bags  
Order number: 77 40 2 451 359\*



(+) = "and" – this item must be ordered at the same time  
(o) = "or" – this item may be ordered as an alternative option

## DESIGN



### COVERS FOR TELELEVER AND SWING-ARM BEARING

**AVAILABLE FOR**  
R 1200 R

Only for model codes 0378, 0398  
R 1200 RT  
R 1200 S  
R 1200 ST  
R 1200 GS  
R 1200 GS Adventure

Turned aluminium caps are a stylish, high-quality alternative to the partially plastic standard caps on the fork bridge and Telelever.

**PART NUMBERS**

**Covers for Telelever and swing-arm bearing**  
(two required for Telelever; one required for left swing-arm bearing)  
Order number: 31 42 7 706 048\*

### CUSTOMIZING MACHINED PARTS

**AVAILABLE FOR**  
R 1200 R

Only for model codes 0400, 0490  
R 1200 GS  
Only for model codes 0450, 0460  
R 1200 GS Adventure  
Only for model codes 0470, 0480

Crafted with the utmost attention to detail, each BMW Motorrad Machined Part is unique. The designs are the result of close collaboration with Roland Sands, the Californian designer, trendsetter and customization expert. So all BMW Motorrad Machined Parts also feature the "by Roland Sands Design" signature logo. The high-quality surfaces of these aluminium parts boast bold contrasts in Glossy Black and are produced in a series of complex processing steps, some of which are performed manually. All BMW Motorrad Machined Parts can be combined with the full range of Original BMW Motorrad Equipment. To be fitted and/or enabled in a specialist workshop, and ideally at your BMW Motorrad dealership.

**PART NUMBERS: R 1200 R<sup>1</sup>, R 1200 GS<sup>2</sup>, R 1200 GS ADVENTURE**

**Machined cylinder head cover** (image 1)  
Order number: Order number: 77 12 2 448 369\*  
**Machined oil filler cap** (image 2)  
Order number: Order number: 77 12 2 447 778\*

**PART NUMBERS**

**Machined swing-arm bearing cover** (image 3)  
Order number: Order number: 77 25 2 447 694\*  
**Machined rear axle cover** (image 4)  
Order number: Order number: 77 25 2 446 856\*  
**Machined cover for angular gearbox mount** (image 5)  
Order number: Order number: 77 25 2 447 694\*



\* Original BMW Motorrad equipment is available from your BMW Motorrad dealer.



### COVERS FOR FORK BRIDGE

#### AVAILABLE FOR

R 1200 R  
Only for model codes 0378, 0398  
R 1200 GS  
R 1200 GS Adventure

Turned aluminium caps are a stylish, high-quality alternative to the partially plastic standard caps on the fork bridge and Telelever.

#### PART NUMBER

**Fork bridge caps**  
Order number: 31 42 7 708 547\*



### CHROME PARTS

#### AVAILABLE FOR

R 1200 R  
Only for model codes 0400, 0490  
R 1200 RT  
Only for model codes 0430, 0440  
R 1200 GS  
Only for model codes 0450, 0460  
R 1200 GS Adventure  
Only for model codes 0470, 0480

Chrome-plated parts are an eye-catching addition to your bike.

The chrome-plated parts are respectively identical in form to the standard parts.

To be fitted and/or enabled in a specialist workshop, and ideally at your BMW Motorrad dealership.



#### PART NUMBERS

**Chrome-plated cylinder head cover, left** (image 1)  
Order number: 11 12 7 722 435\*

**Chrome-plated cylinder head cover, right**  
Order number: 11 12 7 722 436\*

(+) Chrome ISA screw with bushing (four required)  
Order number: 11 12 7 723 214\*

**Chrome-plated custom mirrors** (two required)  
Order number: 71 60 7 699 091\* (image 2)

**Chrome-plated expansion tank cap, left**  
Order number: 32 72 8 543 781\* (image 3)

**Chrome-plated expansion tank cap, right**  
Order number: 32 72 8 543 782\*



### SAFETY SCREW FOR OIL FILLER CAP

#### AVAILABLE FOR

R 1200 R  
R 1200 RT  
R 1200 S  
R 1200 ST  
R 1200 GS  
R 1200 GS Adventure

The high-quality safety screw for the oil filler cap is locked using a special Allen key, preventing theft or contamination of oil circulation. It also features the BMW boxer logo.

#### PART NUMBER

**Safety screw for oil filler cap**  
Order number: 71 60 7 696 117\*

(+) = "and" – this item must be ordered at the same time  
(o) = "or" – this item may be ordered as an alternative option



### TELELEVER JOINT COVER

#### AVAILABLE FOR

R 1200 R  
Only for model codes 0378, 0398

This chrome cover for the R 1200 R is the ideal complement to the fork bridge and Telelever caps.

#### PART NUMBER

**Telelever joint cover**  
Order number: 31 42 2 338 002\*

### SILVER SPOKED WHEEL

#### AVAILABLE FOR

R 1200 R  
Only for model codes 0400, 0490

High-quality cross-spoke wheels are a stylish way to personalize your bike.

To be fitted and/or enabled in a specialist workshop, and ideally at your BMW Motorrad dealership. Not available in conjunction with TPC.



### EXTENDED FRONT MUDGUARD

#### AVAILABLE FOR

R 1200 GS  
Only for model codes 0303, 0313, 0450, 0460

A renowned hallmark of the GS Adventure, the extended front mudguard underlines the off-road look and helps prevent scratching.

Not available in conjunction with LED auxiliary headlights.

#### PART NUMBERS

**Extended front mudguard**  
Order number: 46 61 7 705 386\*

(+) Plug-in nut, self-locking (two required)  
Order number: 46 63 7 694 548\*

(+) Raised head screw (two required)  
Order number: 06 32 7 657 966\*



### PAINTED SEAT HUMP COVER

#### AVAILABLE FOR

R 1200 S

Mounted instead of the pillion seat, the seat hump cover adds an extra dash of style to the motorcycle.

#### PART NUMBERS

**Seat hump cover, Titanium Silver**  
Order number: 71 60 7 696 570\*

**Seat hump cover, Night Black**  
Order number: 71 60 7 696 569\*

**Seat hump cover, Neon Yellow Metallic**  
Order number: 71 60 7 696 567\*

(+) 3x raised flange head screw  
Order number: 06 32 7 651 212\*



#### PART NUMBERS

**Silver spoked wheel, front**  
Order number: 77 21 8 546 282\*

**Silver spoked wheel, rear**  
Order number: 77 21 8 546 288\*

(+) 5x Wheel bolt  
Order number: 36 31 7 668 389\*

### GS DECOR STICKER SET

#### AVAILABLE FOR

R 1200 GS (from 2008 construction year)  
 R 1200 GS Adventure (Adv. from 2008 construction year)  
 The sticker set in Racing Red and Racing Blue Metallic is perfectly tailored to your vehicle. These highly durable stickers really stand out thanks to their vivid and metallic colour effects. The pack comes with instructions and application aids so they can be easily applied without creating air bubbles.

#### Set contents:

- Sticker set for: Mudguard, fuel tank, pannier, top box, aluminium rims (K25), spoke rims (K25 Adventure), rim base decor
- Application aids (squeegee, application liquid, cleaning cloth)
- Installation instructions

#### PART NUMBERS

**Sticker set** (image 1)  
 Order number: 77 31 2 455 680

**Adventure sticker set** (image 2)  
 Order number: 77 31 2 455 681

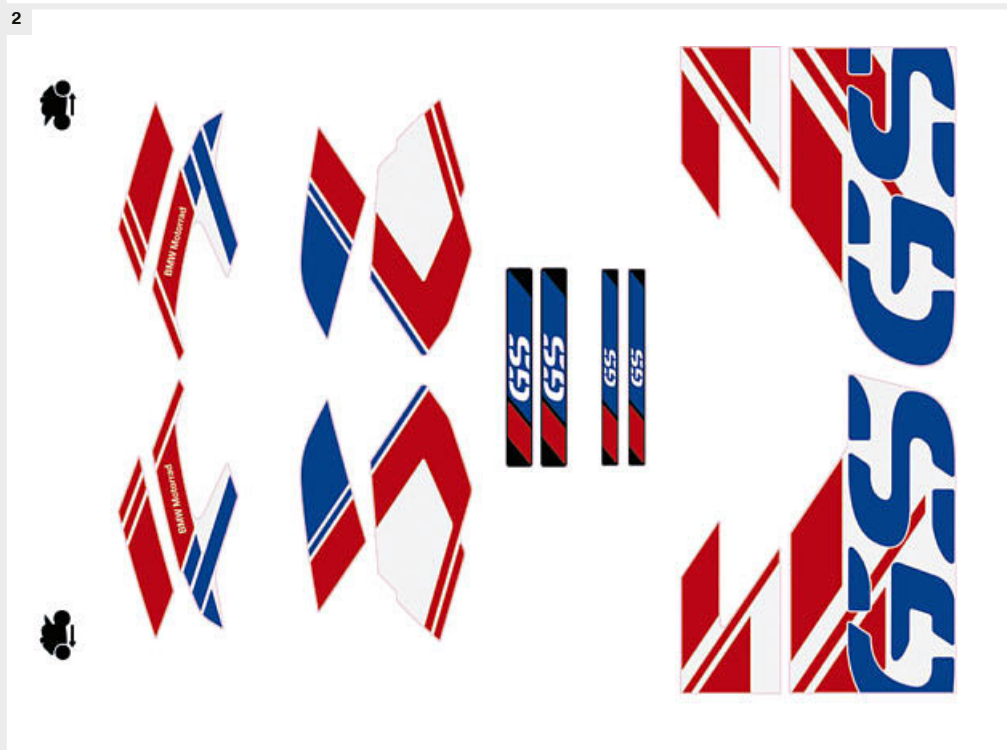
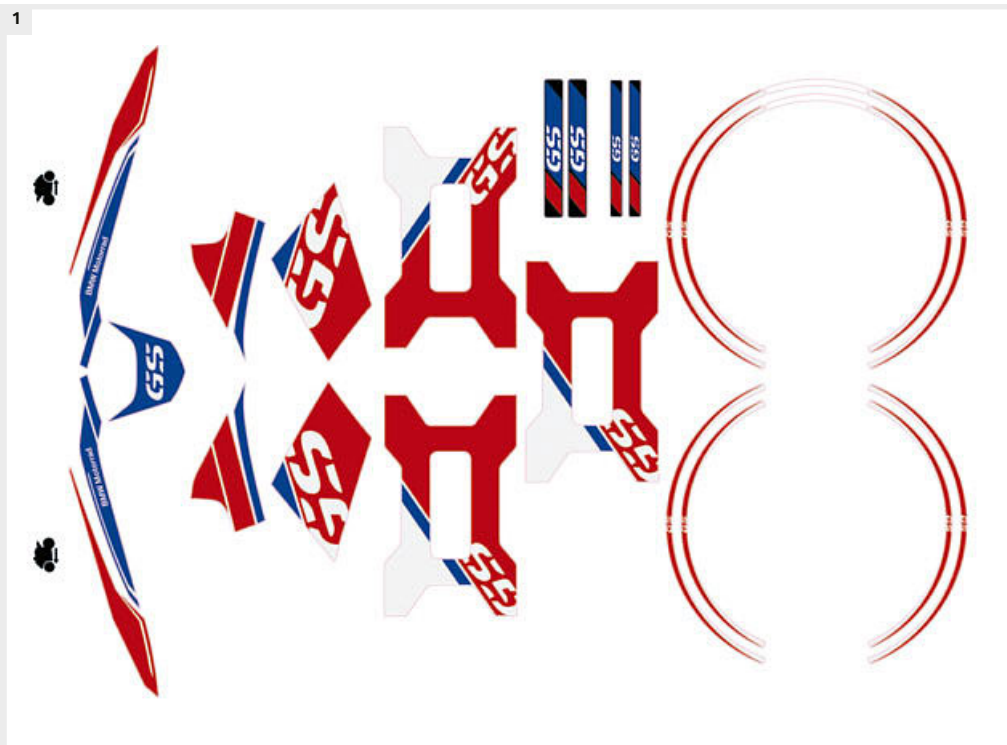

\* Original BMW Motorrad equipment is available from your BMW Motorrad dealer.



### LED INDICATORS

#### AVAILABLE FOR

R 1200 R  
R 1200 GS  
R 1200 GS Adventure

Cutting-edge design inside and out. The LED indicators deliver significantly longer bulb life – a shining example of efficiency.

To be fitted and/or enabled in a specialist workshop, and ideally at your BMW Motorrad dealership.

#### PART NUMBER: R 1200 R

**LED indicators** (four required)  
Order number: 63 13 8 522 499\*

#### PART NUMBERS: R 1200 GS, R 1200 GS ADVENTURE

**LED indicators, front** (two required)  
Order number: 63 13 8 522 499\*

**LED indicator, rear, left**  
Order number: 63 23 8 522 501\*

**LED indicator, rear, right**  
Order number: 63 23 8 522 502\*

(+) 4x Adapter cable for LED indicators  
Order number: 71 60 7 711 284\*

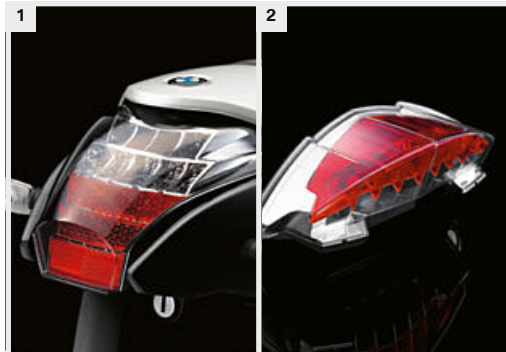

### LED REAR LIGHT

#### AVAILABLE FOR

R 1200 R  
R 1200 GS  
Only for model codes 0307, 0317

Sleek rear lights with state-of-the-art LED technology fuse style with technical wizardry. Practically wear-free, they increase safety in road traffic.

Note differences in national-market specifications.

To be fitted and/or enabled in a specialist workshop, and ideally at your BMW Motorrad dealership.

#### PART NUMBER: R 1200 R

**LED rear lights** (image 1)  
Order number: 63 21 8 526 957\*

#### PART NUMBER: R 1200 GS

**LED rear lights** (image 2)  
Order number: 71 60 7 703 818\*

(+) Cable harness for rear light  
Order number: 61 12 7 702 078\*

(+) Raised head screw  
Order number: 6 32 7 657 966\*

## ERGONOMICS & COMFORT



### HIGH WINDSHIELD

#### AVAILABLE FOR

R 1200 R

The high windshield makes the R 1200 R even more of a touring machine, coming into its own on long stretches of motorways.

#### PART NUMBERS

**High windshield**  
Order number: 71 60 7 699 604\*

(+) Attachment for high windshield  
Order number: 71 60 7 699 573\*  
Only for model codes 0378, 0398

(+) Attachment for high windshield  
Order number: 77 33 7 714 440\*  
Only for model codes 0400, 0490

(+) = "and" – this item must be ordered at the same time  
(o) = "or" – this item may be ordered as an alternative option



### TINTED WINDSHIELD

#### AVAILABLE FOR

R 1200 S  
R 1200 ST  
R 1200 GS  
R 1200 GS Adventure

The tinted windshield gives the bike a sportier look. Same design and size as the standard windshield.

#### PART NUMBER: R 1200 S

**Tinted windshield** (image 1)  
Order number: 71 60 7 698 100\*

#### PART NUMBER: R 1200 ST

**Tinted windshield** (image 2)  
Order number: 71 60 7 698 099\*

#### PART NUMBER: R 1200 GS

**Tinted windshield** (image 3)  
Order number: 71 60 7 698 098\*

#### PART NUMBERS: R 1200 GS ADVENTURE

**Tinted windshield** (image 4)  
Order number: 71 60 7 708 532\*

(+) 4x Raised head screw  
Order number: 71 60 7 654 904\*

(+) Cover for windshield adjustment, left  
Order number: 46 63 7 692 501\*

(+) Cover for windshield adjustment, right  
Order number: 46 63 7 692 502\*

(+) 2x Torx screw for plastic  
Order number: 51 13 7 057 671\*

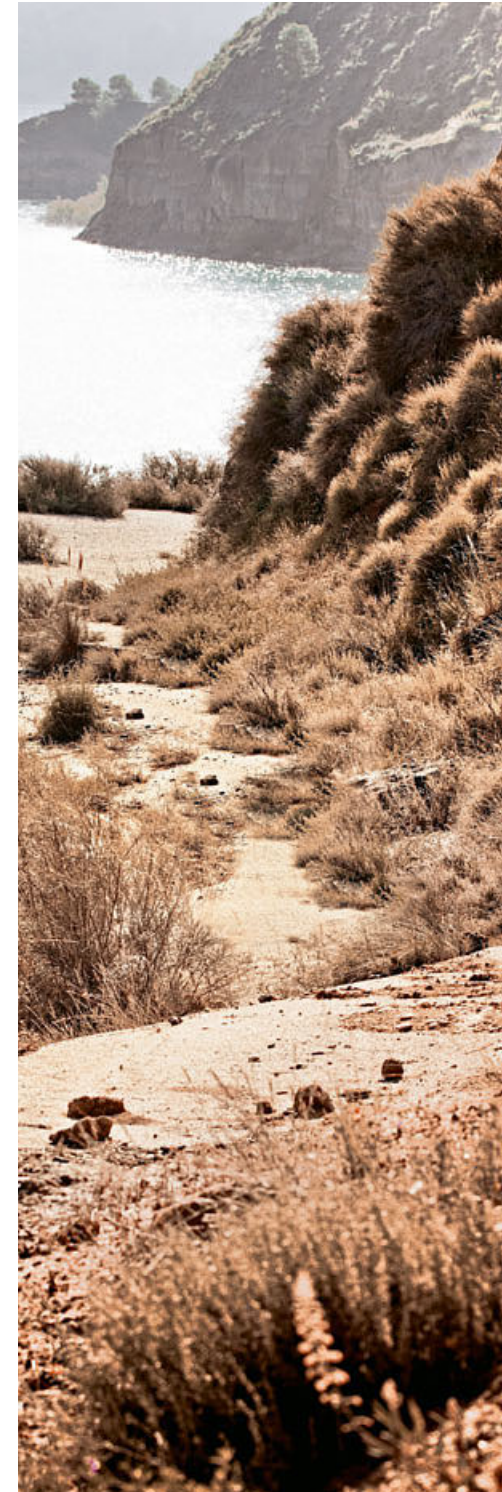

\* Original BMW Motorrad equipment is available from your BMW Motorrad dealer.



### SPORT WINDSHIELD

#### AVAILABLE FOR

R 1200 R

Offering the wind protection of a far larger screen, the sport windshield variants deflect wind away from the rider, providing noticeable relief. It also enhances the classic roadster look of the R 1200 R.

#### PART NUMBER: R 1200 R

**Sport windshield, tinted** (image 1)  
Order number: 71 60 7 704 107\*

**(o) Sport windshield, clear** (image 2)  
Order number: 46 63 7 697 209\*

(+) Attachment for sport windshield  
Order number: 71 60 7 699 566\*  
Only for model codes 0378, 0398

(+) Attachment for sport windshield  
Order number: 77 33 7 714 419\*  
Only for model codes 0400, 0490

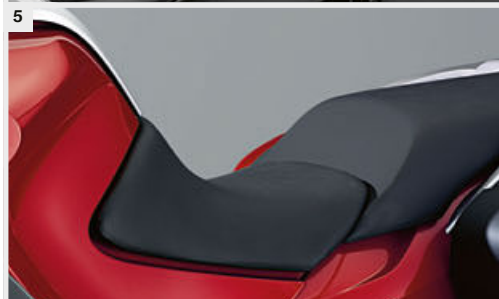

### SEATS

#### AVAILABLE FOR

R 1200 R

R 1200 RT

#### PART NUMBERS: R 1200 R

**Comfort seat** (image 1)  
seat height: 800 mm; step length: 1,840 mm  
Order number: 52 53 7 719 485\*

**Exclusive comfort seat** (not shown)  
seat height: 800 mm; step length: 1,840 mm  
Exclusive design and materials add a stylish personal touch.  
Order number: 77 34 8 546 033\*

**High comfort seat** (not shown)  
seat height: 830 mm; step length: 1,860 mm  
Order number: 52 53 7 719 484\*

**Sport seat** (not shown)  
seat height: 800 mm; step length: 1,800 mm  
Order number: 52 53 7 706 416\*

**Extra low seat, Black** (image 2)  
seat height: 760 mm; step length: 1,740 mm  
Order number: 52 53 7 719 114\*

**Low seat, Black** (not shown)  
seat height: 770 mm; step length: 1,760 mm  
Order number: 52 53 7 698 379\*

**High seat, Black** (image 3)  
seat height: 830 mm; step length: 1,860 mm  
Order number: 52 53 7 706 418\*

#### PART NUMBERS: R 1200 RT

**Comfort seat** (image 4)  
Order number: 77 34 7 708 878\*

**Extra low seat, Black** (image 5)  
Order number: 77 34 7 708 877\*

**Low seat, Grey** (not shown)  
Order number: 52 53 7 698 252\*

**Low seat, Black** (not shown)  
Order number: 52 53 7 683 636\*

(+) = "and" – this item must be ordered at the same time  
(o) = "or" – this item may be ordered as an alternative option

### RIDER SEAT/PILLION SEAT

#### AVAILABLE FOR

R 1200 ST

R 1200 GS

R 1200 GS Adventure

#### PART NUMBERS: R 1200 ST

**Low rider seat, Black** (not shown)  
seat height: 780/800 mm

Order number: 52 53 7 683 687\*

(+) 6x rubber buffer

Order number: 52 53 2 309 507\*

(+) Support

Order number: 52 53 7 694 059\*

(+) 2x rubber support

Order number: 52 53 1 230 319\*

(+) Seat front carrier part

Order number: 52 53 7 677 678\*

(+) Pipe

Order number: 52 53 7 677 679\*

#### PART NUMBERS: R 1200 GS

**Rider seat, Grey** (not shown)  
seat height: 850/870 mm; step length: 1,890/1,940 mm

Order number: 52 53 7 682 895\*

**Rider seat, Black** (image 1)  
seat height: 850/870 mm; step length: 1,890/1,940 mm

Order number: 52 53 7 708 010\*

**Low rider seat, Grey** (not shown)  
seat height: 820 mm; step length: 1,820 mm

Order number: 52 53 7 693 490\*

**Low rider seat, Black** (image 2)  
seat height: 820 mm; step length: 1,820 mm

Order number: 52 53 7 693 489\*

**Pillion seat, Grey** (not shown)

Order number: 52 53 7 682 897\*

**Pillion seat, Black** (image 1)

Order number: 52 53 7 680 639\*

#### PART NUMBERS: R 1200 GS, R 1200 GS ADVENTURE

**Rider seat, Black/Aluminium** (image 3)  
R 1200 GS:

seat height: 870/890 mm; step length: 1,910/1,950 mm

R 1200 GS Adventure:

seat height: 890/910 mm; step length: 1,960/2,000 mm

Order number: 52 53 7 709 355\*

**Rider seat, Black/Red** (image 4)  
R 1200 GS:

seat height: 870/890 mm; step length: 1,910/1,950 mm

R 1200 GS Adventure:

seat height: 890/910 mm; step length: 1,960/2,000 mm

Order number: 52 53 7 698 246\*

**Pillion seat, Black/Aluminium** (image 3)

Order number: 52 53 7 698 252\*

**Pillion seat, Black/Red** (image 4)

Order number: 52 53 7 709 357\*

\* Original BMW Motorrad equipment is available from your BMW Motorrad dealer.



### ADJUSTABLE FOOTBRAKE LEVER (NOT SHOWN)

#### AVAILABLE FOR

R 1200 GS

Wider than before and height-adjustable, the footbrake lever improves the control of brake pressure when riding in a standing position.

To be fitted and/or enabled in a specialist workshop, and ideally at your BMW Motorrad dealership.

#### PART NUMBER

**Adjustable footbrake lever**

Order number: 35 21 7 692 671\*

### WIDE ENDURO FOOT PEGS (NOT SHOWN)

#### AVAILABLE FOR

R 1200 GS

R 1200 ST

Wide Enduro foot pegs provide a better foothold and improve control when riding off-road or in a standing position.

#### PART NUMBERS

**Wide Enduro foot peg, left**  
Order number: 46 71 7 694 557\*

**Wide Enduro foot peg, right**  
Order number: 46 71 7 694 558\*

(+) Torsion spring, front (two required)  
Order number: 46 71 7 683 137\*

(+) Bolts (two required)  
Order number: 46 71 7 680 530\*

(+) Locking clip (two required)  
Order number: 07 11 9 901 545\*



### HEATED GRIPS

#### AVAILABLE FOR

R 1200 R  
Only for model codes 0378, 0398, 0400, 0490

R 1200 RT  
Only for model codes 0368, 0388, 0430, 0440

R 1200 S  
R 1200 ST  
R 1200 GS  
Only for model codes 0303, 0307, 0313, 0317, 0450, 0460

R 1200 GS Adventure  
Only for model codes 0380, 0382, 0390, 0382, 0397, 0470, 0490

Keep your hands as warm as you like with retrofittable heated grips. To be fitted and/or enabled in a specialist workshop, and ideally at your BMW Motorrad dealership.

#### PART NUMBERS: R 1200 R, R 1200 GS, R 1200 S, R 1200 GS ADVENTURE

**Heated grip, left**  
Order number: 61 31 7 727 067\* (not shown)

K25/K27: (+) Lens screw with flange  
Order number: 61 31 7 682 091\*

**Heated grip, right**  
Order number: 61 31 7 671 612\* (image 3)  
Order number: 61 31 7 695 470\* (image 4)

(+) Multifunction switch for heated grip, right  
Order number: 61 31 7 694 982\*

(+) Lens screw with flange  
Order number: 61 31 7 682 091\*

(o) Multifunction switch, right  
Order number: 61 31 8 546 174\*

(+) Multifunction switch cover, right  
Order number: 61 31 7 708 231\*

(+) Flange head screw (two required)  
Order number: 61 31 7 683 119\*

#### R 1200 ST & R 1200 GS & R 1200 GS ADVENTURE

**Heated grip, left**  
Order number: 61 31 7 671 605\* (not shown)

(+) Thread cutting screw  
Order number: 61 31 7 687 509\*

**Heated grip, right**  
Order number: 61 31 2 352 054\* (not shown)

(+) Multifunction switch for heated grip, right  
Order number: 61 31 7 694 982\*

(+) Lens screw with flange  
Order number: 61 31 7 682 091\*



#### PART NUMBERS: R 1200 RT

**Heated grip, left**  
Order number: 61 31 7 694 813\* (image 1)  
Order number: 61 31 7 713 247\* (image 2)

**Heated grip, right**  
Order number: 61 31 7 710 438\*

(+) Thread cutting screw (two required)  
Order number: 61 31 7 687 509\*

(+) Multifunction switch for heated grip, right  
Order number: 61 31 7 708 334\*

(o) Multifunction switch for heated grip and seat heating, right  
Order number: 61 31 7 708 336\*

(o) Multifunction switch for heated grip and on-board computer, right  
Order number: 61 31 7 708 338\*

(o) Multifunction switch for heated grip, seat heating and on-board computer, right  
Order number: 61 31 7 708 340\*

(+) Heated grip, right  
Order number: 61 31 7 708 236\* (image 1)

(+) Multifunction switch, right  
Order number: 61 31 8 546 170\*

## NAVIGATION



### BMW MOTORRAD NAVIGATION SYSTEMS

#### AVAILABLE FOR

R 1200 R  
R 1200 RT  
R 1200 ST  
R 1200 GS  
R 1200 GS Adventure

Where am I? Where do I want to go, and what's the most scenic way to get there?

BMW Motorrad navigation devices show you where to go. Made specifically for motorcyclists, they're easy to fit and use – even with gloves on – and come with lifetime map updates.

The new BMW Motorrad Navigator VI is your ticket to the tour of your dreams. A whole new level of adventure awaits thanks to the “winding roads” route option, “avoid motorways” feature and the “round trip” function, which configures journeys based on time, distance or stopover. The circular polarization filter (CPOL) on the display minimizes reflection and improves contrast, ensuring the screen is easy to read, even in direct sunlight. 16 GB of flash storage, and the ability to stream music from your smartphone, are the ultimate luxury.

Thanks to Bluetooth® technology, the sophisticated BMW Motorrad Navigator Street (with easy-to-read 4.3" display) is compatible with the optional BMW Motorrad communication system and comes with a host of handy features.

Now you can charge your phone out on the road with BMW Motorrad's waterproof smartphone cradle. Charging takes place wirelessly or via a plug-in connection. The display and navigation functions are perfectly positioned in your field of vision and can be easily operated from the cradle.

For smartphones with 5" displays or smaller.

Max. dimensions: 13.8 cm x 7.3 cm x 1.1 cm.

BMW Motorrad navigation devices and the BMW Motorrad smartphone cradle can only be mounted using the BMW Motorrad navigation device bracket.

For more detailed information, contact your BMW Motorrad dealership or go online at [bmw-motorrad.com](http://bmw-motorrad.com).

Note differences in national-market specifications.

#### PART NUMBERS: R 1200 R, R 1200 RT, R 1200 ST, R 1200 GS, R 1200 GS ADVENTURE

**BMW Motorrad Navigator VI (EU) (US)** (image 1)  
Order number: 77 52 8 355 749\*

**BMW Motorrad Navigator Street (EU)** (image 2)  
Order number: 77 52 8 557 855\*

**BMW Motorrad Navigator Street (US)** (image 2)  
Order number: 77 52 8 557 856\*

#### PART NUMBER: R 1200 R, R 1200 GS, R 1200 GS ADVENTURE

**BMW Motorrad smartphone cradle** (image 3)  
Order number: 77 52 8 563 125\*

### BLUETOOTH RETROFIT (NOT SHOWN)

#### AVAILABLE FOR

R 1200 RT

Only for model codes 0430, 0440

For more detailed information, contact your BMW Motorrad dealership or go online at [bmw-motorrad.com](http://bmw-motorrad.com).

#### PART NUMBER

**Bluetooth retrofit**

Order number: 77 52 8 528 450\*

\* Original BMW Motorrad equipment is available from your BMW Motorrad dealer.





### BRACKET FOR BMW MOTORRAD NAVIGATION DEVICES

#### AVAILABLE FOR

R 1200 R  
R 1200 RT  
R 1200 ST  
R 1200 GS  
R 1200 GS Adventure

Bracket for mounting BMW Motorrad navigation devices. Guarantees a good view of the navigation system.

Brackets shown are attached to older BMW Motorrad navigation devices. Compatibility with newer-generation devices is guaranteed.

#### PART NUMBER: R 1200 R

#### Bracket for BMW Motorrad navigation devices (image 1)

Order number: 71 60 7 700 742\*  
Only for model codes 0378, 0398

(+) Screw (four required)  
Order number: 32 71 7 652 161\*  
Only for model codes 0378, 0398

#### Bracket for BMW Motorrad navigation devices (image 2)

Order number: 77 52 8 521 803\*  
Only for model codes 0400, 0490

(+) Screw (four required)  
Order number: 77 52 7 724 321\*  
Only for model codes 0400, 0490

#### PART NUMBERS: R 1200 RT

#### Bracket for BMW Motorrad navigation devices (image 3)

Order number: 71 60 7 687 853\*  
Only for model codes 0368, 0388

#### Bracket for BMW Motorrad navigation devices (image 4)

Order number: 71 60 7 708 580\*  
Only for model codes 0430, 0440

#### PART NUMBERS: R 1200 ST

#### Bracket for BMW Motorrad navigation devices (not shown)

Order number: 71 60 7 676 948\*  
(+) Vehicle-specific base plate

Order number: 71 60 7 685 635\*

#### PART NUMBERS: R 1200 GS

#### Bracket for BMW Motorrad navigation devices (image 5)

Order number: 71 60 7 682 427\*  
Only for model codes 0307, 0317

(+) Screw (four required)  
Order number: 32 71 7 652 161\*

Only for model codes 0307, 0317

#### PART NUMBERS: R 1200 GS, R 1200 GS ADVENTURE

#### Bracket for BMW Motorrad navigation devices (image 6)

Order number: 71 60 7 713 903\*  
Only for model codes 0303, 0313, 0450, 0460

(+) Mounting bracket  
Order number: 71 60 7 707 369\*

## SAFETY

### HAND PROTECTORS

#### AVAILABLE FOR

R 1200 GS

Protect the hands and instruments from wind and rain, and from low-hanging branches and flying stones on off-road trails.

#### PART NUMBERS

**Hand protectors (image 1)**  
Order number: 71 60 7 706 209\*  
Only for model codes 0303, 0313, 0450, 0460

**Hand protectors (image 2)**  
Order number: 71 60 7 705 265\*  
Only for model codes 0307, 0317



### LARGE UPPER SECTION OF HAND PROTECTORS

#### AVAILABLE FOR

R 1200 GS  
Only for model codes 0303, 0313, 0450, 0460  
R 1200 GS Adventure  
Only for model codes 0380, 0390, 0470, 0480

The large upper section of the hand protector adds an extra barrier against wind, rain and flying stones.

#### PART NUMBERS

**Large upper section of hand protector, left**  
Order number: 71 60 7 705 221\*

**Large upper section of hand protector, right**  
Order number: 71 60 7 705 222\*



### HANDLEBAR CROSS-BRACE

#### AVAILABLE FOR

R 1200 GS  
Only for model codes 0303, 0313, 0450, 0460  
R 1200 GS Adventure  
Only for model codes 0380, 0390, 0470, 0480

Adds more stability to the handlebars. For more detailed information, contact your BMW Motorrad dealership or go online at [www.bmw-motorrad.com](http://www.bmw-motorrad.com).

#### PART NUMBER

**Handlebar cross-brace**  
Order number: 71 60 7 701 942\*





### HANDLEBAR CROSS-BRACE PROTECTION

#### AVAILABLE FOR

R 1200 GS  
Only for model codes 0303, 0313, 0450, 0460  
R 1200 GS Adventure  
Only for model codes 0380, 0390, 0470, 0480

Available in Black/White or Red/Black.  
For more detailed information, contact your BMW Motorrad dealership or go online at [www.bmw-motorrad.com](http://www.bmw-motorrad.com).

#### PART NUMBERS

**Handlebar cross-brace protection, Black/White**  
Order number: 46 63 7 706 632\*

**Handlebar cross-brace protection, Red/Black**  
Order number: 46 63 7 706 633\* (not shown)



### LED AUXILIARY HEADLIGHTS

#### AVAILABLE FOR

R 1200 GS  
R 1200 GS Adventure  
Only for model codes 0303, 0313, 0450, 0460

State-of-the-art LED auxiliary headlights increase safety in road traffic.

To be fitted and/or enabled in a specialist workshop, and ideally at your BMW Motorrad dealership.

The auxiliary headlights are approved for use as fog lights, and may only be used in poor weather conditions. Country-specific road traffic regulations apply.

#### PART NUMBERS

**LED auxiliary headlights** (two required)  
Order number: 63 17 8 532 147\*

**Auxiliary headlight plug** (two required)  
Order number: 63 17 7 723 139\*

**Mounting parts for auxiliary headlights**  
Order number: 63 17 7 709 686\*

#### ALSO FOR R 1200 GS

**Bracket for auxiliary headlight, left**  
Order number: 71 60 7 715 831\*

**Bracket for auxiliary headlight, right**  
Order number: 71 60 7 715 832\*

#### ALSO FOR R 1200 GS ADVENTURE

**Bracket for auxiliary headlights**  
Order number: 63 17 7 721 640\*



### HEADLIGHT GUARD (FOR OFF-ROAD USE ONLY)

#### AVAILABLE FOR

R 1200 GS  
Only for model codes 0303, 0313, 0450, 0460  
R 1200 GS Adventure

Protects headlight from flying stones during off-road use. With snaplock system for quick attachment and removal.

Only for off-road use (not homologated for road use).

#### PART NUMBER

**Headlight guard (for off-road use only)**  
Order number: 63 12 7 695 770\*



### STAINLESS STEEL ENGINE PROTECTION BAR

#### AVAILABLE FOR

R 1200 R  
R 1200 GS

In situations where impacts are unavoidable, the engine protection bar helps prevent damage to the cylinder area of the engine. The R 1200 GS is designed for heavy off-road use on tricky terrain, so this is the ideal complement to the standard underride guard.



#### PART NUMBERS: R 1200 R

**Stainless steel engine protection bar** (not shown)  
Order number: 77 14 7 727 575\*  
Only for model codes 0400, 0490

**Stainless steel engine protection bar** (image 1)  
Order number: 71 60 7 709 642\*  
Only for model codes 0378, 0398

Cannot be fitted at the same time as the plastic cylinder head cover guard (71 60 7 693 843).

#### PART NUMBER: R 1200 GS

**Stainless steel engine protection bar** (image 2)  
Order number: 71 60 7 677 270\*



### ENDURO ALUMINIUM BASH PLATE

#### AVAILABLE FOR

R 1200 GS  
Only for model codes 0303, 0313, 0450, 0460  
R 1200 GS Adventure  
Only for model codes 0380, 0390, 0470, 0480

The Enduro aluminium bash plate was specially made for off-road use, and protects the bottom half of the engine from impacts and ricochets.

#### PART NUMBER

**Enduro aluminium bash plate**  
Order number: 77 14 7 724 326\*



### STAINLESS STEEL FRAME PROTECTOR

#### AVAILABLE FOR

R 1200 GS  
R 1200 GS Adventure

The high-quality frame protector, made from laser-cut stainless steel, helps prevent scratching.

#### PART NUMBER

**Stainless steel frame protector**  
Order number: 77 25 7 728 715\*

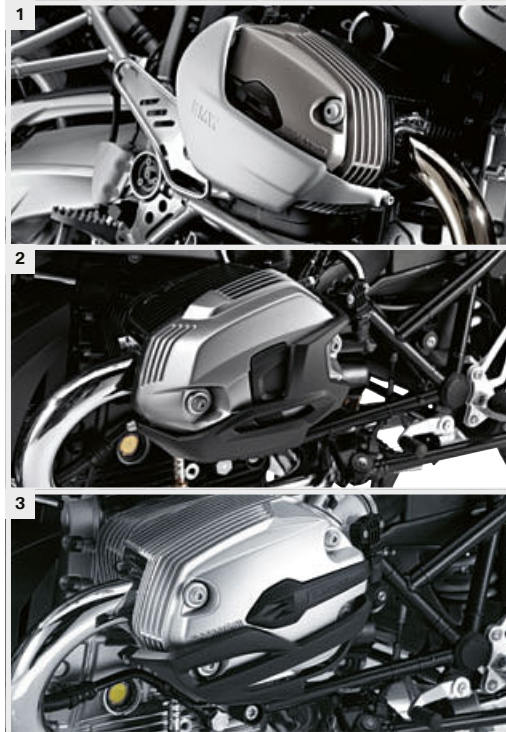

### CYLINDER HEAD COVER GUARD

#### AVAILABLE FOR

R 1200 R  
Only for model codes 0378, 0398, 0400, 0490  
R 1200 RT  
Only for model codes 0368, 0388, 0430, 0440  
R 1200 GS  
Only for model codes 0303, 0307, 0313, 0317, 0450, 0460  
R 1200 S  
R 1200 ST  
R 1200 GS Adventure  
Only for model codes 0380, 0382, 0390, 0397, 0470, 0480

Comprehensive protection for the most exposed parts of the boxer engine. On tough terrain, it prevents impacts and scratches which may break the casing.

The cylinder head cover guard is made of glass-fibre-reinforced plastic and protects the cylinder head from damage.

#### PART NUMBER: R 1200 R, R 1200 RT, R 1200 GS

**Plastic cylinder head cover guard**  
(image 2)  
Order number: 71 60 7 719 449\*

#### PART NUMBERS: R 1200 R, R 1200 RT, R 1200 GS, R 1200 S, R 1200 ST,

**Plastic cylinder head cover guard**  
(image 3)  
Order number: 71 60 7 693 843\*

#### PART NUMBER: R 1200, R 1200 GS ADVENTURE

**Aluminium cylinder head cover guard**  
(image 1)  
Order number: 71 60 7 658 636\*

### REAR MUDGUARD (NOT SHOWN)

#### AVAILABLE FOR

R 1200 RT  
R 1200 ST

### CENTRE STAND

#### AVAILABLE FOR

R 1200 R  
R 1200 RT  
R 1200 ST

To be fitted and/or enabled in a specialist workshop, and ideally at your BMW Motorrad dealership.

#### PART NUMBERS

**Centre stand**  
Order number: 46 52 7 675 690\*

(+) Tilt stand mounting kit  
Order number: 71 60 7 653 509\*

Without lowered suspension option (+) for tilt stand  
Order number: 46 52 7 675 690\*

With lowered suspension option (+) for tilt stand  
Order number: 46 52 7 715 154\*



#### PART NUMBER: R 1200 ST

**Rear mudguard**  
Order number: 71 60 7 695 880\*  
(+) Mudguard, front part, rear  
Order number: 46 62 7 679 918\*  
(+) Mudguard, rear part, rear  
Order number: 46 62 7 673 714\*

#### PART NUMBER: R 1200 RT

**Rear mudguard**  
Order number: 71 60 7 694 184\*

### ANTI-THEFT ALARM SYSTEM WITH REMOTE CONTROL (NOT SHOWN)

#### AVAILABLE FOR

R 1200 R  
R 1200 RT  
R 1200 S  
R 1200 ST  
R 1200 GS  
R 1200 GS Adventure

If the motorcycle is moved or struck violently, the system responds with a clearly audible signal and a flashing warning light.

Note differences in national-market specifications.

To be fitted and/or enabled in a specialist workshop, and ideally at your BMW Motorrad dealership.

#### PART NUMBERS

**Anti-theft alarm system with remote control**  
Order number: 77 53 8 545 003\*

(+) Resistor  
Order number: 61 13 7 668 405\*

(+) Battery  
Order number: 65 75 2 337 504\*



\* Original BMW Motorrad equipment is available from your BMW Motorrad dealer.

# F MODEL RANGE

## Vehicle-specific accessories for:

F 800 S  
Model code 0216, 0226

F 800 ST  
Model code 0234, 0244

F 800 GT  
Model code 0B03, 0B13, 0B33

F 800 R  
Model code 0217, 0227, 0224, 0B04 (MÜ),  
0B14 (MÜ), 0B34 (MÜ)

F 650 GS  
Model code 0218, 0228

F 700 GS  
Model code 0B01, 0B11, 0B31, 0B06 (TÜ),  
0B16 (TÜ), 0B36 (TÜ)

F 800 GS  
Model code 0219, 0229, 0B02 (MÜ), 0B12 (MÜ),  
0B23 (MÜ), 0B07 (TÜ), 0B17 (TÜ), 0B37 (TÜ)

F 800 GS Adventure  
Model code 0B05, 0B15

**HP Parts** ————— 312

**Storage** ————— 313

**Design** ————— 322

**Ergonomics & Comfort** ————— 324

**Navigation** ————— 330

**Safety** ————— 332



## HP PARTS



### HP HAND LEVERS

#### AVAILABLE FOR

F 800 R  
Only for model codes 0B04, 0B14

The high-quality CNC-milled clutch and brake levers switch easily between four settings via an adjusting screw. They're a great way to personalize your bike, and a stylish ever-present in your primary field of view. To be fitted and/or enabled in a specialist workshop, and ideally at your BMW Motorrad dealership.

#### PART NUMBERS

**HP milled clutch lever** (image 1)  
Order number: 77 22 8 551 860\*

**HP milled brake lever** (image 2)  
Order number: 71 60 7 706 739\*



### HP MILLED FOOT PEGS

#### AVAILABLE FOR

F 800 R  
Only for model codes 0B04, 0B14

The high-quality CNC-milled rider foot pegs add to the dynamic look of the motorcycle, and their corrugated surfaces ensure a firm grip. To be fitted and/or enabled in a specialist workshop, and ideally at your BMW Motorrad dealership.

#### PART NUMBERS

**HP milled foot peg, left**  
Order number: 77 25 8 551 861\*

**HP milled foot peg, right**  
Order number: 77 25 8 551 862\*



### HP SPORT SILENCER

#### AVAILABLE FOR

F 650 GS  
F 700 GS  
F 800 GS  
F 800 GS Adventure

The sleek, high-quality slip-on silencer with titanium sleeve and carbon end cap delivers a powerful rumble. Approx. 2.3kg lighter than standard silencer.

#### PART NUMBER

##### HP sport silencer

Order number: 71 60 7 713 339\*  
Model codes 0B01, 0B11, 0B31 (F 700 GS)  
Model codes 0219, 0229, 0B02, 0B12, 0B23 (F 800 GS)  
F 800 GS Adventure

Order number: 71 11 8 567 781\* (not shown)  
Model codes 0B06, 0B16, 0B36 (F 700 GS)  
Model codes 0B07, 0B17, 0B37 (F 800 GS)



### HP SPORT SILENCER

#### AVAILABLE FOR

F 800 GT  
F 800 R

The sleek, high-quality slip-on silencer with titanium sleeve delivers a powerful rumble. Approx. 1.8kg lighter than standard silencer.

#### PART NUMBER

##### HP sport silencer

Order number: 77 11 8 535 470\*

## STORAGE

### SPORT PANNIERS

#### AVAILABLE FOR

F 800 R  
F 800 S  
F 800 ST  
F 800 GT

Splash-proof sport panniers come with waterproof inner bags (one per pannier). Capacity is adjustable from 15 to 25l on each side – ample room for a helmet in each pannier.

#### PART NUMBERS: F 800 S, F 800 ST

**Sport pannier, left** (image 1)  
Order number: 71 60 7 722 363\*

#### PART NUMBERS: F 800 GT, F 800 R

**Sport pannier, left** (image 2)  
Order number: 71 60 7 719 740\*

#### PART NUMBERS

**Sport pannier, right**  
Order number: 71 60 7 722 364\*

(+) Mounting kit (one required per pannier)  
Order number: 71 60 7 680 840\*

(+) Locking cylinder according to VIN number (one required per pannier)  
Order number: 51 25 7 681 200\*

(o) Repair kit for locking cylinder  
Order number: 51 25 7 698 204\*





### TOURING PANNIERS

#### AVAILABLE FOR

F 800 R  
Only for model codes 0B04, 0B14  
F 800 GT

The splash-proof, hard-shell plastic panniers have a total capacity of approx. 55 l (28 l left, 27 l right).

#### PART NUMBERS

##### Touring pannier, left

Order number: 77 41 8 529 893\*

##### Touring pannier, right

Order number: 77 41 8 529 894\*

(+) Mounting kit (one required per pannier)

Order number: 71 60 7 680 840\*

(+) Locking cylinder according to VIN number (one required per pannier)

Order number: 51 25 7 681 200\*



### VARIABLE PANNIER, BLACK

#### AVAILABLE FOR

F 650 GS  
F 700 GS  
F 800 GS

The variable panniers are fitted with a patented adjustment system, allowing the capacity to be reduced from 67 l (29 l left, 38 l right) per pannier by 10 l to 47 l (19 l left, 28 l right). The pannier is narrower when capacity is reduced, which is useful in city traffic.

#### PART NUMBERS

##### Variable pannier, Black, left

Order number: 71 60 7 696 299\*

##### Variable pannier, Black, right

Order number: 71 60 7 696 300\*

(+) Locking cylinder according to VIN number (one required per pannier)

Order number: 51 25 7 681 199\*



### PANNIER RACKS

#### AVAILABLE FOR

F 800 R  
F 800 S  
F 800 ST  
F 800 GT

Only available in conjunction with luggage grid.

#### PART NUMBERS: F 800 R, F 800 GT

##### Pannier racks (image 1)

Order number: 71 60 7 719 744\*

#### PART NUMBERS: F 800 S, F 800 ST

##### Pannier racks (not shown)

Order number: 71 60 7 693 915\*

#### PART NUMBER

##### Pannier racks for variable panniers

Order number: 77 42 8 535 862\*



### PANNIER RACKS FOR VARIABLE PANNIERS

#### AVAILABLE FOR

F 650 GS  
F 700 GS  
F 800 GS



### INNER BAG FOR VARIABLE PANNIERS

#### AVAILABLE FOR

F 650 GS  
F 700 GS  
F 800 GS

The practical, waterproof inner bag with removable carry strap keeps its contents well protected. As with the variable pannier, its capacity is adjustable.

#### PART NUMBERS

##### Inner bag for variable pannier, left

Order number: 71 60 7 687 610\*

##### Inner bag for variable pannier, right and variable top box (not shown)

Order number: 71 60 7 687 611\*



### INNER BAG FOR TOURING PANNIERS

#### AVAILABLE FOR

F 800 R  
Only for model codes 0B04, 0B14  
F 800 GT

The rigid inner bags are waterproof thanks to a sealed liner and drawstring closure for the main compartment. A carry handle and detachable strap make them essential travel companions.



#### PART NUMBERS

##### Inner bag for touring pannier, left

Order number: 77 49 8 534 714\*

##### Inner bag for touring pannier, right

Order number: 77 49 8 534 715\*



**PANNIER HOLDERS FOR ALUMINIUM PANNIERS**

**AVAILABLE FOR**  
F 800 GS

**PART NUMBERS**

**Aluminium pannier rack, left**  
Order number: 46 54 8 543 921\*  
**Aluminium pannier rack, right**  
Order number: 46 54 8 543 922\*  
(+) Crossbar, rear  
Order number: 46 54 8 543 918\*  
(+) Case holder mounting kit  
Order number: 77 42 8 543 674\*



**ALUMINIUM PANNIERS**

**AVAILABLE FOR**  
F 800 GS  
F 800 GS Adventure

Suitable for off-road use, these sturdy aluminium panniers have a generous capacity of approx. 82 l (38 l left, 44 l right).

**PART NUMBERS**

**Aluminium pannier, left**  
Order number: 77 41 8 566 447\*  
**Aluminium pannier, right**  
Order number: 77 41 8 566 448\*  
(+) Locking cylinder according to VIN number (three required per pannier)  
Order number: 51 25 7 681 199\*



**INNER BAG FOR ALUMINIUM PANNIERS**

**AVAILABLE FOR**  
F 800 GS  
F 800 GS Adventure

High-quality materials and a robust design make the watertight inner bag suitable for use both in and on top of aluminium panniers.

**PART NUMBERS**

**Inner bag for aluminium pannier, left**  
Order number: 71 60 7 699 055\*  
**Inner bag for aluminium pannier, right**  
Order number: 71 60 7 699 056\*



**SMALL TOP BOX, 28 l**

**AVAILABLE FOR**  
F 800 R  
F 800 S  
F 800 ST  
F 800 GT

The waterproof top box is easy to mount on the luggage grid and has enough space inside for a helmet.

**PART NUMBERS**

**Small top box, 28 l**  
Order number: 77 43 7 724 352\*  
(+) Locking cylinder according to VIN number  
Order number: 51 25 7 681 200\*



**INNER BAG FOR SMALL TOP BOX, 28 l**

**AVAILABLE FOR**  
F 800 R  
F 800 S  
F 800 ST  
F 800 GT

Slipping seamlessly into the overall design of the bike, these inner bags are both sturdy and lightweight. Handy compartments for small items and carry handles that can be tucked away make them essential travel companions.

**PART NUMBER**

**Inner bag for small top box, 28 l**  
Order number: 71 60 7 680 541\*



**LUGGAGE GRID**

**AVAILABLE FOR**  
F 800 R  
F 800 S  
F 800 ST  
F 800 GT

**PART NUMBER**

**Luggage grid**  
Order number: 71 60 7 693 917\*  
(+) Raised head screw (four required)  
Order number: 34 11 7 672 808\*



(+) = "and" – this item must be ordered at the same time  
(o) = "or" – this item may be ordered as an alternative option



**BACKREST PAD FOR SMALL TOP BOX, 28 l**

**AVAILABLE FOR**  
F 800 R  
F 800 S  
F 800 ST  
F 800 GT

**PART NUMBER**

**Backrest pad for small top box, 28 l**  
Order number: 71 60 7 693 672\*

\* Original BMW Motorrad equipment is available from your BMW Motorrad dealer.



### VARIABLE TOP BOX

**AVAILABLE FOR**  
F 650 GS  
F 700 GS  
F 800 GS

Like the panniers, the top box is fitted with a patented adjustment system, which increases capacity from 25l to 35l.



### VARIABLE TOP BOX RACK

**AVAILABLE FOR**  
F 650 GS  
F 700 GS  
F 800 GS

#### PART NUMBER

##### Variable top box rack

Order number: 77 44 8 523 309\*  
(F 650 GS, F 800 GS only for model codes 0219, 0229)  
Order number: 77 44 8 533 793\*  
(F 700 GS, F 800 GS only for model codes 0B02, 0B12, 0B07, 0B17)



### BACKREST PAD FOR VARIABLE TOP BOX

**AVAILABLE FOR**  
F 650 GS  
F 700 GS  
F 800 GS

#### PART NUMBER

**Backrest pad for variable top box**  
Order number: 71 60 7 688 877\*



### BACKREST PAD FOR ALUMINIUM TOP BOX

**AVAILABLE FOR**  
F 800 GS  
F 800 GS Adventure

#### PART NUMBER

**Backrest pad for aluminium top box**  
Order number: 77 44 8 546 808\*



### ALUMINIUM TOP BOX

**AVAILABLE FOR**  
F 800 GS  
F 800 GS Adventure

#### PART NUMBERS

##### Aluminium top box

Order number: 77 43 8 566 446\*  
(F 800 GS Adventure, F 800 GS only for model codes 0B02, 0B12, 0B07, 0B17)  
Order number: 71 60 7 722 309\*  
(F 800 GS only for model codes 0219, 0229)

(+) Locking cylinder according to VIN number (four required)  
Order number: 51 25 7 687 199\*



### SMALL LUGGAGE GRID

**AVAILABLE FOR**  
F 650 GS  
F 700 GS  
F 800 GS

#### PART NUMBER

**Small luggage grid**  
Order number: 71 60 7 701 810\*

#### PART NUMBERS

##### Variable top box

Art.-Nr. 77 43 8 527 850\*  
(F 650 GS, F 800 GS model codes 0219, 0229)  
Art.-Nr. 77 43 8 533 792\*  
(F 700 GS, F 800 GS model codes 0B02, 0B12, 0B07, 0B17)

(+) Locking cylinder according to VIN number  
Order number: 51 25 7 681 199\*



### RACK FOR ALUMINIUM TOP BOX

**AVAILABLE FOR**  
F 800 GS  
F 800 GS Adventure

#### PART NUMBER

**Rack for aluminium top box**  
Order number: 71 60 7 696 292\*

### TANKBAG

#### AVAILABLE FOR

F 650 GS  
F 700 GS  
F 800 GS  
Only for model codes 0219, 0229, 0B02, 0B12  
F 800 GS Adventure

Tankbag with waterproof main compartment, A4 map pocket and two splash-proof patch pockets on the sides. Capacity expands from approx. 12l to 17l. Can be combined with the BMW Motorrad Navigator.

#### PART NUMBER

**Tankbag**  
Order number: 77 45 7 726 998\*



### INNER BAG FOR ALUMINIUM TOP BOX

**AVAILABLE FOR**  
F 800 GS  
F 800 GS Adventure

High-quality materials and a robust design make the watertight inner bag suitable for use both in and on top of the aluminium top box.

#### PART NUMBER

**Inner bag for aluminium top box**  
Order number: 71 60 7 699 057\*



### CARRY HANDLE FOR ALUMINIUM PANNIER OR TOP BOX

**AVAILABLE FOR**  
F 800 GS  
Only for model codes 0B02, 0B12, 0B07, 0B17  
F 800 GS Adventure

#### PART NUMBER

**Carry handle for aluminium panniers or top boxes**  
Order number: 77 49 8 543 224\*





### TANKBAG

#### AVAILABLE FOR

F 800 R  
F 800 GT

The tankbag is highly practical, with a waterproof main compartment, easy-access map pocket, carry handle and a removable carry strap. Capacity expands from approx. 10l to 14l. Can be combined with the BMW Motorrad Navigator.

#### PART NUMBER

**Tankbag**  
Order number: 77 45 8 534 702\*



### TANKBAG

#### AVAILABLE FOR

F 800 R  
F 800 S  
F 800 ST

This tankbag has a large waterproof main compartment (approx. 12l) and a pocket (with window) for smaller items. It fits various BMW Motorrad models and can be combined with BMW Motorrad Navigator systems.

#### PART NUMBERS

**Tankbag**  
Order number: 71 60 7 691 391\*  
(+) Tankbag mounting kit  
Order number: 71 60 7 699 045\*



### UNIVERSAL TANKBAG

#### AVAILABLE FOR

F 800 R  
F 800 S  
F 800 ST  
F 800 GT

A waterproof tankbag with a waterproof main compartment. Fits various BMW Motorrad models. Capacity expands from approx. 10l to 12l. Can be combined with BMW Motorrad Navigator systems.

#### PART NUMBERS

**Universal tankbag**  
Order number: 77 49 7 726 994\*  
(+) Universal tankbag attachment  
Order number: 77 49 8 520 292\*



### ATACAMA LUGGAGE ROLL

#### AVAILABLE FOR

F 800 GS  
F 800 GS Adventure

Versatile softbag system with various features. Specially made for globetrotters who aren't afraid of tough conditions, with extremely tear-resistant materials and removable watertight inner bags. Thanks to a quick-fastening system, the side bags can be quickly attached to the luggage rack and are just as easy to remove. Backpack-style luggage roll.

Only available in conjunction with pannier mountings for aluminium panniers.



#### PART NUMBER

**Atacama luggage roll, 40 l**  
Order number: 77 40 2 451 381\*



### ATACAMA SIDE BAGS

#### AVAILABLE FOR

F 800 GS  
F 800 GS Adventure

Only available in conjunction with pannier racks for aluminium panniers.

#### PART NUMBER

**Atacama side bags kit**  
Order number: 77 40 2 451 375\*  
(+) Atacama side bag adapter  
Order number: 77 40 2 451 361\*



### ENDURO REAR BAG

#### AVAILABLE FOR

F 650 GS  
F 700 GS  
F 800 GS

Only for model codes 0219, 0229, 0B02, 0B12

A highly water-resistant main compartment and handy pockets for small items make this the perfect solution for Enduro riding. It can be mounted on either the rear of the bike or the small luggage grid.

#### PART NUMBER

**Enduro rear bag**  
Order number: 71 60 7 711 245\*

## DESIGN

### PRIMED PILLION SEAT COVER

#### AVAILABLE FOR

F 800 R  
F 800 S  
F 800 ST

The pillion seat cover gives the motorcycle a dynamic single-seater look. It comes pre-primed, so can be painted the same colour as your bike.  
For more detailed information, contact your BMW Motorrad dealership or go online at [bmw-motorrad.com](http://bmw-motorrad.com)

#### PART NUMBER

**Primed pillion seat cover**  
Order number: 71 60 7 702 129



### PLASTIC ENGINE SPOILER

#### AVAILABLE FOR

F 800 R  
F 800 S

The plastic engine spoiler in Black is both stylish and striking.  
Not available in conjunction with engine protection bar.

#### PART NUMBER

**Plastic engine spoiler**  
Order number: 71 60 7 699 463\*  
(+) Cable tie with holder  
Order number: 61 13 6 918 644\*



### PLASTIC RADIATOR TRIM

#### AVAILABLE FOR

F 800 R  
Only for model codes 0217, 0227

A Black single-piece plastic surround for the radiator that coordinates with the intake manifold fairing, rounding off the bike design in dynamic fashion.

#### PART NUMBER

**Plastic radiator trim**  
Order number: 71 60 7 699 466\*



### ALUMINIUM RADIATOR TRIM

#### AVAILABLE FOR

F 800 R  
Only for model codes 0217, 0227

Made from oxidized aluminium, this radiator trim is a striking, lightweight and elegant alternative to the standard plastic trim.

#### PART NUMBER

**Aluminium radiator trim**  
Order number: 71 60 7 719 734\*



### LED INDICATORS

#### AVAILABLE FOR

F 650 GS  
F 700 GS  
F 800 R  
F 800 S  
F 800 ST  
F 800 GT  
F 800 GS  
F 800 GS Adventure

Cutting-edge design inside and out. The LED indicators deliver significantly longer bulb life – a shining example of efficiency.

To be fitted and/or enabled in a specialist workshop, and ideally at your BMW Motorrad dealership.

#### PART NUMBERS

**LED indicators, front** (two required)  
Order number: 63 13 8 522 499\*  
**LED indicators, rear** (two required)  
Order number: 63 23 8 522 500\*



### LED REAR LIGHT

#### AVAILABLE FOR

F 800 S  
F 800 ST  
F 800 GT  
K73 (0217, 0227)  
K73 Mü (0B04, 0B14)

Sleek rear lights with state-of-the-art LED technology fuse style with technical wizardry. Practically wear-free, they increase safety in road traffic.

Note differences in national-market specifications..

To be fitted and/or enabled in a specialist workshop, and ideally at your BMW Motorrad dealership.

#### PART NUMBER

**LED rear light**  
Order number: 63 21 7 714 557\*

#### ALSO FOR F 800 S, F800 ST

(+) Adapter cable for rear light  
Order number: 71 60 7 712 418\*

#### ALSO FOR F 800 R

(+) Cable harness for rear light  
Order number: 61 12 7 702 078\*

#### ALSO FOR F 800 GT

(+) Cable harness for tail section  
Order number: 61 11 8 532 308\*

## ERGONOMICS & COMFORT



### SMALL WINDSHIELD

**AVAILABLE FOR**  
F 700 GS  
F 800 GS

**PART NUMBERS: F 700 GS**

**Small windshield, tinted** (image 1)  
Order number: 46 63 8 531 917\*

(+) Windshield bracket set  
Order number: 77 33 8 531 603\*

**PART NUMBER: F 800 GS**

**Small windshield, clear** (image 2)  
Order number: 71 60 7 713 296\*

(+) Windshield bracket set  
Order number: 77 33 8 531 600\*



### LARGE WINDSHIELD

**AVAILABLE FOR**  
F 650 GS  
F 700 GS  
F 800 GS

The large windshield increases protection from wind and rain. The tinted version underscores the dynamic look of the bike.

**PART NUMBERS**

**Large windshield, clear** (image 1)  
Order number: 46 63 7 694 991\*

**Large windshield, tinted** (image 2)  
Order number: 71 60 7 713 296\*

(+) Windshield bracket set  
Order number: 77 33 8 531 603\*



### TOURING WINDSHIELD

**AVAILABLE FOR**  
F 650 GS  
F 800 GS

The angular design fits in effortlessly with the robust Enduro look of the front end. The rider also benefits from added protection from wind and rain, which is ideal for longer tours.

**PART NUMBERS**

**Touring windshield**  
Order number: 71 60 7 683 059\*  
(+) Windshield bracket set  
Order number: 77 33 8 531 600\*

### TINTED WINDSHIELD

**AVAILABLE FOR**  
F 800 GT

The tinted windshield gives the bike a sportier look. Same design and size as the clear windshield.

**PART NUMBER**

**Tinted windshield**  
Order number: 77 33 8 560 429\*



### HIGH WINDSHIELD

**AVAILABLE FOR**  
F 800 S  
F 800 ST

The tinted windshield gives the bike a sportier look. Same design and size as the clear windshield.

**PART NUMBERS**

**High windshield** (image 1)  
Order number: 71 60 7 693 913\*

**High windshield, tinted** (image 2)  
Order number: 71 60 7 702 588\*



### LOW WINDSHIELD

**AVAILABLE FOR**  
F 800 S  
F 800 ST

The tinted windshield gives the bike a sportier look. Same design and size as the clear windshield.

**PART NUMBERS**

**Low windshield** (image 1)  
Order number: 71 60 7 699 114\*

**Low windshield, tinted** (image 2)  
Order number: 71 60 7 702 589\*



### SPORT WINDSHIELD

**AVAILABLE FOR**  
F 800 R  
Only for model codes 0217, 0227

The varnished windshield underlines the dynamic design of the F 800 R and provides significant protection from wind when travelling at speed outside built-up areas.

**PART NUMBERS**

**Sport windshield, White Aluminium 2 Matt Metallic**  
Order number: 46 63 7 687 956\*

**Sport windshield, Alpine White**  
Order number: 46 63 7 692 590\*

**Sport windshield, Fire Orange**  
Order number: 46 63 7 687 958\*

**Sport windshield, Granite Grey Metallic**  
Order number: 46 63 7 728 450\*

**Sport windshield, Neon Yellow Metallic**  
Order number: 46 63 7 728 449\*

**Sport windshield, Magma Red**  
Order number: 46 63 8 533 495\*

**Sport windshield, Mineral Silver Metallic**  
Order number: 46 63 8 533 496\*

(+) Cockpit fairing bracket  
Order number: 71 60 7 682 053\*

(+) Mounting parts for sport windshield  
Order number: 71 60 7 720 645\*

(+) Raised head screw (four required)  
Order number: 46 54 7 685 133\*



### HIGH WINDSHIELD

**AVAILABLE FOR**  
F 800 GT  
F 800 R  
Only for model codes 0B04, 0B14

Improves protection from wind and rain – perfect for touring.

**PART NUMBER**

**High windshield, F 800 GT** (image 1)  
Order number: 77 33 8 559 918\*

**High windshield, F 800 R** (image 2)  
Order number: 77 33 8 545 827\*



**WIND DEFLECTORS**

**AVAILABLE FOR**  
F 800 GS  
Only for model codes 0219, 0229

**PART NUMBER**  
**Wind deflector set**  
Order number: 71 60 7 713 100\*



**LOW SEAT, BLACK**

**AVAILABLE FOR**  
F 650 GS  
F 700 GS  
F 800 GS  
F 700 GS and F 650 GS:  
seat height: 790 mm; step length: 1,760 mm  
F 800 GS:  
seat height: 850 mm; step length: 1,880 mm

**PART NUMBER**  
**Low seat, Black**  
Order number: 52 53 7 695 013\*



**COMFORT SEAT**

**AVAILABLE FOR**  
F 650 GS  
F 700 GS  
F 800 GS  
F 700 GS and F 650 GS:  
seat height: 835 mm; step length: 1,840 mm  
F 800 GS:  
seat height: 895 mm; step length: 1,960 mm

**PART NUMBER**  
**Comfort seat**  
Order number: 52 53 8 546 377\*

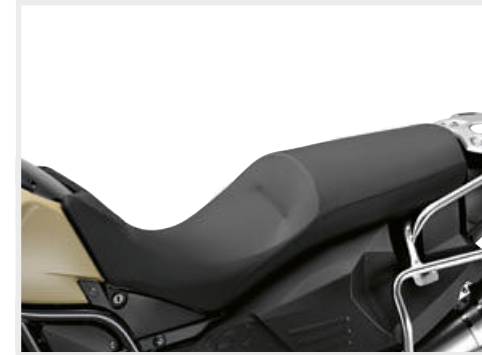

**LOW SEAT, BLACK**

**AVAILABLE FOR**  
F 800 GS Adventure  
seat height: 890 mm; step length: 1,960 mm

**PART NUMBER**  
**Low seat, Black**  
Order number: 52 53 8 535 834\*

**SEAT, BLACK (NOT SHOWN)**

**AVAILABLE FOR**  
F 800 R  
F 800 S  
F 800 ST  
F 800 GT

A range of adjustable seats offers riders of all heights the chance to find the safest and most comfortable set-up that suits them.

**PART NUMBERS: F 800 R, F 800 S, F 800 ST**

**Seat in Black**  
Order number: 52 53 8 554 098\*  
Only for model codes 0217, 0227

**PART NUMBER: F 800 R**  
**Seat in Black**  
Order number: 52 53 8 549 484\*

Only for model codes 0B04, 0B14



**HIGH SEAT, BLACK**

**AVAILABLE FOR**  
F 650 GS  
F 800 GS  
Only for model codes 0219, 0229  
F 650 GS:  
seat height: 820 mm; step length: 1,810 mm  
F 800 GS:  
seat height: 880 mm; step length: 1,930 mm

**PART NUMBER**  
**High seat, Black**  
Order number: 52 53 7 695 000\*



**SEAT, GREY/BLACK**

**AVAILABLE FOR**  
F 700 GS  
F 800 GS  
Only for model codes 0B02, 0B12, 0B07, 0B17  
F 700 GS:  
seat height: 820 mm; step length: 1,810 mm  
F 800 GS:  
seat height: 880 mm; step length: 1,930 mm

**PART NUMBER**  
**Seat, Grey/Black**  
Order number: 52 53 8 554 382\*



**RALLYE SEAT**

**AVAILABLE FOR**  
F 650 GS  
F 700 GS  
F 800 GS  
F 700 GS and F 650 GS:  
seat height: 860 mm; step length: 1,870 mm  
F 800 GS:  
seat height: 920 mm; step length: 1,990 mm

**PART NUMBER**  
**Rallye seat**  
Order number: 71 60 7 719 751\*



**HIGH SEAT**

**AVAILABLE FOR**  
F 800 GS Adventure  
seat height: 890 mm; step length: 1,960 mm

**PART NUMBER**  
**High seat, Black/Sand Rover** (image 1)  
Order number: 52 53 8 535 833\*  
**High seat, Black/Red** (image 2)  
Order number: 52 53 8 541 618\*  
**High seat, Black/Stone Grey** (image 3)  
Order number: 52 53 8 556 406\*





### LOW SEAT, BLACK

#### AVAILABLE FOR

F 800 R  
F 800 S  
F 800 ST  
F 800 GT

A range of adjustable seats offers riders of all heights the chance to find the safest and most comfortable set-up that suits them.

#### PART NUMBER

**Low seat, Black**  
Order number: 52 53 8 554 099\*



### EXTRA LOW SEAT, BLACK

#### AVAILABLE FOR

F 800 R  
F 800 GT

A range of adjustable seats offers riders of all heights the chance to find the safest and most comfortable set-up that suits them.

#### PART NUMBER

**Extra low seat, Black**  
Order number: 52 53 8 554 097\*



### COMFORT SEAT

#### AVAILABLE FOR

F 800 R  
Only for model codes 0B04, 0B14  
F 800 GT

A range of adjustable seats offers riders of all heights the chance to find the safest and most comfortable set-up that suits them.

#### PART NUMBER

**Comfort seat** (image 1)  
Order number: 52 53 8 528 623\*  
**High comfort seat** (image 2)  
Order number: 77 34 8 544 479\*

### HEATED GRIPS (NOT SHOWN)

#### AVAILABLE FOR

F 650 GS  
F 700 GS  
F 800 R  
F 800 S  
F 800 ST  
F 800 GT  
F 800 GS  
F 800 GS Adventure

Keep your hands as warm as you like with retrofittable heated grips. To be fitted and/or enabled in a specialist workshop, and ideally at your BMW Motorrad dealership.

For more detailed information, contact your BMW Motorrad dealership or go online at [bmw-motorrad.com](http://bmw-motorrad.com)

#### PART NUMBERS: F 650 GS, F 800 S, F 800 ST, F 800 GS<sup>1</sup>

**Heated grip, left**  
Order number: 61 31 7 727 067\*

(+) Multifunction switch for heated grip, right  
Order number: 61 31 7 694 982\*

**Heated grip, right**  
Order number: 61 31 7 708 286\*

(+) Raised head screw with flange (two required)  
Order number: 61 31 7 682 091\*

#### PART NUMBERS: F 700 GS, F 800 R, F 800 GT F 800 GS<sup>1</sup>, F 800 GS ADVENTURE

**Heated grip, left**  
Order number: 61 31 7 708 227\*

**Heated grip, right**  
Order number: 61 31 7 708 228\*

(+) Multifunction switch, right  
Order number: 61 31 8 567 704\*

#### ALSO FOR F 700 GS, F 800 GS<sup>2</sup>

(+) Raised head screw with flange (two required)  
Order number: 61 31 7 682 091\*

#### ALSO FOR F 800 GS ADVENTURE WITH ABS AND ASC FOR OFF-ROAD MODE

(o) Multifunction switch, right  
Order number: 61 31 8 546 176\*

<sup>1</sup> Only for model codes 0219, 0229  
<sup>2</sup> Only for model codes 0B02, 0B12



### WIDE ENDURO FOOT PEG

#### AVAILABLE FOR

F 700 GS  
F 800 GS  
Only for model codes 0B02, 0B12, 0B07, 0B17

Wide Enduro foot pegs provide a better foothold and improve control when riding off-road or in a standing position.

#### PART NUMBERS

**Enduro foot peg, wide, left**  
Order number: 77 25 8 533 661\*

(+) Torsion spring (two required)  
Order number: 77 25 8 533 675\*

**Enduro foot peg, wide, right**  
Order number: 77 25 8 533 662\*



### RUBBER INSERT FOR WIDE ENDURO FOOT PEGS

#### AVAILABLE FOR

F 700 GS  
F 800 GS  
Only for model codes 0B02, 0B12, 0B07, 0B17

Wide Enduro foot pegs provide a better foothold and improve control when riding off-road or in a standing position.

#### PART NUMBERS

**Rubber insert for wide Enduro foot pegs** (two required)  
Order number: 46 71 7 696 748\*

(+) Brace for rubber insert for foot pegs (two required)  
Order number: 46 71 8 549 672\*

(+) Hexagonal nut (four required)  
Order number: 07 12 9 905 752\*

(+) Bush (four required)  
Order number: 46 71 8 525 854\*



### AUTOMATIC CHAIN LUBRICATION SYSTEM

#### AVAILABLE FOR

F 650 GS  
F 700 GS  
Only for model codes 0B01, 0B11  
F 800 R  
F 800 GS  
Only for model codes 0219, 0229, 0B02, 0B12  
F 800 GS Adventure

Lubricates the drive chain automatically, whenever the engine is running. Constant lubrication reduces friction within the chain drive, minimizing wear and tear and power loss. To be fitted and/or enabled in a specialist workshop, and ideally at your BMW Motorrad dealership.

For more detailed information, contact your BMW Motorrad dealership or go online at [bmw-motorrad.com](http://bmw-motorrad.com)

#### PART NUMBERS

**Automatic chain lubrication system**  
Order number: 77 10 8 527 720\*

(+) Scottoil, Standard, 250ml  
Order number: 08 31 2 422 246\*

(o) Scottoil, Super, 250ml  
Order number: 08 31 2 422 248\*



\* Original BMW Motorrad equipment is available from your BMW Motorrad dealer.

# NAVIGATION



## BMW MOTORRAD NAVIGATION SYSTEMS

### AVAILABLE FOR

F 700 GS  
F 800 R  
F 800 S  
F 800 ST  
F 800 GT  
F 650 GS  
F 800 GS  
F 800 GS Adventure

Where am I? Where do I want to go, and what's the most scenic way to get there?

BMW Motorrad navigation devices show you where to go. Made specifically for motorcyclists, they're easy to fit and use – even with gloves on – and come with lifetime map updates.

The new BMW Motorrad Navigator VI is your ticket to the tour of your dreams. A whole new level of adventure awaits thanks to the “winding roads” route option, “avoid motorways” feature and the “round trip” function, which configures journeys based on time, distance or stopover. The circular polarization filter (CPOL) on the display minimizes reflection and improves contrast, ensuring the screen is easy to read, even in direct sunlight. 16 GB of flash storage, and the ability to stream music from your smartphone, are the ultimate luxury.

Thanks to Bluetooth® technology, the sophisticated BMW Motorrad Navigator Street (with easy-to-read 4.3" display) Thanks to Bluetooth® technology, the sophisticated BMW Motorrad Navigator Street (with easy-to-read 4.3" display) is compatible with the optional BMW Motorrad communication system and comes with a host of handy features.

Now you can charge your phone out on the road with BMW Motorrad's waterproof smartphone cradle. Charging takes place wirelessly or via a plug-in connection. The display and navigation functions are perfectly positioned in your field of vision and can be easily operated from the cradle.

For smartphones with 5" For smartphones with 5" displays or smaller. Max. dimensions: 13.8cm x 7.3cm x 1.1cm. BMW Motorrad navigation devices and the BMW Motorrad smartphone cradle can only be mounted using the BMW Motorrad navigation device bracket.

For more detailed information, contact your BMW Motorrad dealership or go online at [bmw-motorrad.com](http://bmw-motorrad.com)

Note differences in national-market specifications.

### PART NUMBERS

**BMW Motorrad Navigator VI with cradle mount (with map data for Europe)** (see image, top right)  
Order number: 77 52 8 355 749\*

**BMW Motorrad Navigator VI (US)**  
(not shown)

**BMW Motorrad Navigator Street (EU)**  
(see image, centre)  
Order number: 77 52 8 557 855\*

**BMW Motorrad Navigator Street (US)**  
(see image, centre)  
Order number: 77 52 8 557 856\*

**BMW Motorrad Smartphone Cradle**  
(see image, left)  
Order number: 77 52 8 563 125\*

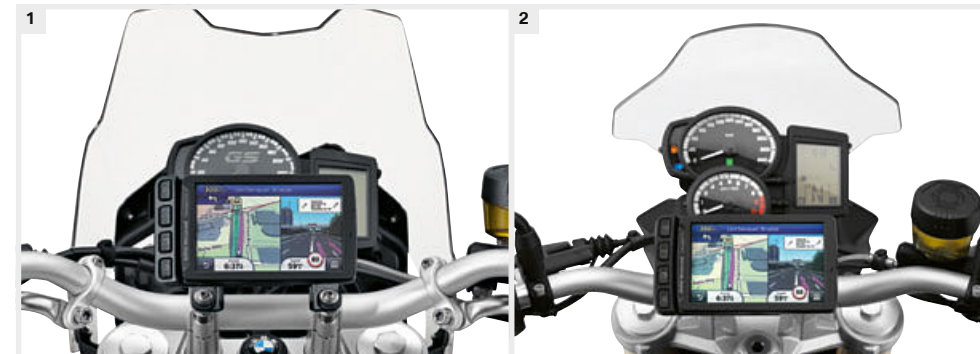

## BRACKET FOR BMW MOTORRAD NAVIGATION DEVICES

### AVAILABLE FOR

F 650 GS  
F 700 GS  
F 800 R  
F 800 S  
F 800 ST  
F 800 GT  
F 800 GS  
F 800 GS Adventure

Bracket for mounting BMW Motorrad navigation devices  
Guarantees a good view of the navigation device.

### PART NUMBERS: F 650 GS, F 700 GS, F 800 GS

**Bracket for BMW Motorrad navigation devices**  
(image 1)

Order number: 77 52 7 724 487\*

(+) Screw (four required)  
Order number: 32 71 7 652 161\*

### PART NUMBERS: F 800 R<sup>1</sup>, F 800 S, F 800 ST

**Bracket for BMW Motorrad navigation devices**  
(not shown)

Order number: 71 60 7 676 948\*

(+) Base plate kit for Navigator  
Order number: 71 60 7 693 126\*

### PART NUMBERS: F 800 R<sup>2</sup>, F 800 GT

**Bracket for BMW Motorrad navigation devices**  
(image 2)

Order number: 77 52 8 529 421\*

(+) Screw (four required)  
Order number: 32 71 7 652 161\*

### PART NUMBERS: F 800 GS ADVENTURE

**Bracket for BMW Motorrad navigation devices**  
(not shown)

Order number: 71 60 7 713 903\*

<sup>1</sup> Only for model codes 0217, 0227

<sup>2</sup> Only for model codes 0B04, 0B14



## SAFETY

### SPOILER ATTACHMENTS FOR LARGE HAND PROTECTORS

#### AVAILABLE FOR

F 650 GS  
F 700 GS  
F 800 GS

The spoiler attachment for the hand protector adds an extra barrier to help keep out wind, rain and flying stones. Only available in conjunction with large hand protectors.

### BOW-SHAPED HAND GUARD

#### AVAILABLE FOR

F 650 GS  
F 700 GS  
F 800 GS

#### PART NUMBERS: F 650 GS

**Bow-shaped hand guard**  
Order number: 71 60 7 716 043\*  
(+) 2x Countersunk screws  
Order number: 32 71 7 717 803\*

#### PART NUMBER: F 700 GS

**Bow-shaped hand guard**  
Order number: 77 32 8 532 948\*

#### PART NUMBERS: F 800 GS<sup>1</sup>

**Bow-shaped hand guard**  
Order number: 71 60 7 714 661\*

(+) 2x Countersunk screws  
Order number: 32 71 7 717 803\*

#### PART NUMBER: F 800 GS<sup>2</sup>

**Bow-shaped hand guard**  
Order number: 77 32 8 532 949\*

<sup>1</sup> Only for model codes 0219, 0229  
<sup>2</sup> Only for model codes 0B02, 0B12, 0B07, 0B17



### HAND PROTECTORS

#### AVAILABLE FOR

F 650 GS  
F 700 GS  
F 800 GS

Protect the hands and instruments from wind and rain, and from low-hanging branches and flying stones on off-road trails. Only available in conjunction with bow-shaped hand guard.

#### PART NUMBER

**Spoiler attachments for large hand protectors**  
Order number: 71 60 7 705 964\*



#### PART NUMBERS

**Large hand protectors** (image 1)  
Order number: 71 60 7 715 135\*

**Small hand protectors** (image 2)  
Order number: 71 60 7 705 963\*



(+) = "and" – this item must be ordered at the same time  
(o) = "or" – this item may be ordered as an alternative option



### HEADLIGHT GUARD (FOR OFF-ROAD USE ONLY)

#### AVAILABLE FOR

F 650 GS  
F 700 GS  
F 800 GS

Protects headlight from flying stones during off-road use. With snaplock system for quick attachment and removal. Only for off-road use (not homologated for road use).

#### PART NUMBER

**Headlight guard (for off-road use only)**  
Order number: 77 51 8 533 756\*



### ENDURO ALUMINIUM BASH PLATE

#### AVAILABLE FOR

F 650 GS  
F 700 GS  
F 800 GS  
F 800 GS Adventure

The robust aluminium bash plate protects the engine and manifold from stones and ricochets during off-road riding. It also emphasizes the tough Enduro look, especially in combination with the engine protection bar. Does not restrict banking angle or movement of feet, etc.

#### PART NUMBERS

**Enduro aluminium bash plate**  
Order number: 71 60 7 702 951\*  
(+) Mounting parts kit  
Order number: 71 60 8 526 643\*

### LED AUXILIARY HEADLIGHTS

#### AVAILABLE FOR

F 800 GS

Only for model codes 0B02, 0B12, 0B07, 0B17  
F 800 GS Adventure

State-of-the-art LED auxiliary headlights increase safety in road traffic.

To be fitted and/or enabled in a specialist workshop, and ideally at your BMW Motorrad dealership.

For more detailed information, contact your BMW Motorrad dealership or go online at [bmw-motorrad.com](http://bmw-motorrad.com)

The auxiliary headlights are approved for use as fog lights, and may only be used in poor weather conditions. Country-specific road traffic regulations apply.



#### PART NUMBERS: F 800 GS

**LED auxiliary headlights** (image 1)  
(two required)

Order number: 63 17 8 556 937\*

(+) Bracket for LED auxiliary headlights

Order number: 77 51 8 530 686\*

(+) Adapter line for LED auxiliary headlights

Order number: 61 12 8 356 909\*

(+) Multifunction switch, left

Order number: 61 31 8 550 043\*

(o) Multifunction switch, left

Order number: 61 31 8 550 041\*

(o) Multifunction switch, left

Order number: 61 31 8 546 227\*

#### PART NUMBERS: F 800 GS, F 800 GS ADVENTURE

**LED auxiliary headlights** (image 2)  
(two required)

Order number: 63 17 8 532 147\*

(+) Bracket for LED auxiliary headlights

Order number: 77 51 8 530 686\*

(+) Cable harness for LED auxiliary headlights

Order number: 61 12 8 534 525\*

(+) Multifunction switch, left

Order number: 61 31 8 550 043\*

(o) Multifunction switch, left

Order number: 61 31 8 550 041\*

(o) Multifunction switch, left

Order number: 61 31 8 550 039\*



### ENGINE PROTECTION BAR

#### AVAILABLE FOR

F 650 GS  
F 700 GS  
F 800 GS

In situations where impacts with the motorcycle are unavoidable, the stainless steel engine protection bar helps prevent damage to the engine.

#### PART NUMBERS: F 650 GS, F 700 GS, F 800 GS

##### Engine protection bar, left

Order number: 71 60 8 405 683\*

##### Engine protection bar, right

Order number: 71 60 7 699 438\*

(+) Protection bar mounting parts kit

Order number: 71 60 7 702 395\*



### ENGINE PROTECTION BAR

#### AVAILABLE FOR

F 800 R  
F 800 S

In situations where impacts with the motorcycle are unavoidable, the stainless steel engine protection bar, painted in Black, helps prevent damage to the engine.

#### PART NUMBERS: F 800 R, F 800 S

##### Engine protection bar

Order number: 71 60 7 695 395\*

Cannot be fitted at the same time as the plastic engine spoiler.



### ANTI-THEFT ALARM SYSTEM WITH REMOTE CONTROL

#### AVAILABLE FOR

F 650 GS  
F 700 GS  
F 800 R  
F 800 S  
F 800 ST  
F 800 GT  
F 800 GS  
F 800 GS Adventure

If the motorcycle is moved or struck violently, the system responds with a clearly audible signal and a flashing warning light.

To be fitted and/or enabled in a specialist workshop, and ideally at your BMW Motorrad dealership.

Note differences in national-market specifications.

#### PART NUMBERS

##### Anti-theft alarm system with remote control

Order number: 77 53 8 545 003\*

(+) Bracket

Order number: 65 75 7 707 271\*

(+) Bracket

Order number: 65 75 7 718 385\*

(+) Resistor

Order number: 61 13 7 668 405\*

#### PART NUMBERS

##### Plastic bash plate

Order number: 11 11 8 526 642\*

(+) Mounting parts kit

Order number: 71 60 8 526 643\*



### PLASTIC BASH PLATE

#### AVAILABLE FOR

F 650 GS  
F 700 GS

The small engine bash plate fits seamlessly into the dynamic GS design of the bike. It protects the engine from flying stones during light off-road use, and can be used at the same time as the engine protection bar.



### REAR MUDGUARD

#### AVAILABLE FOR

F 650 GS  
F 700 GS  
F 800 GS  
F 800 R

Only for model codes 0B04, 0B14

F 800 GT

#### PART NUMBERS: F 800 R, F 800 GT

##### Rear mudguard (not shown)

Order number: 71 60 7 694 184\*

#### PART NUMBER: F 650 GS, F 700 GS, F 800 GS

##### Rear mudguard (image 1)

Order number: 71 60 7 695 031\*

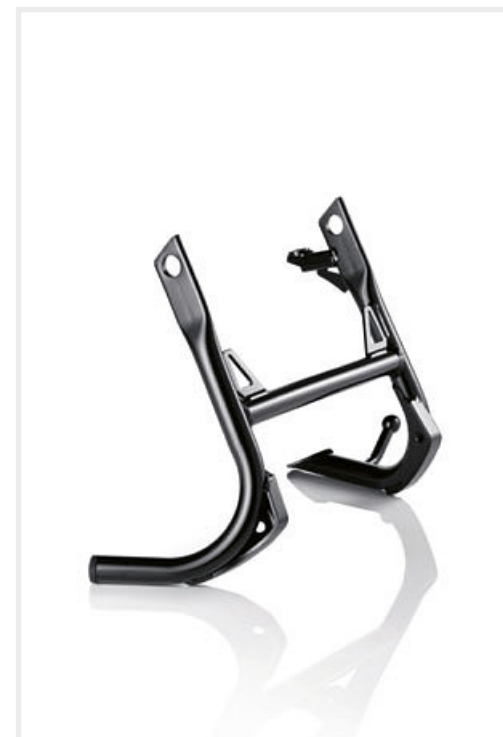

### CENTRE STAND

#### AVAILABLE FOR

F 650 GS  
F 700 GS  
F 800 R  
F 800 S  
F 800 ST  
F 800 GT  
F 800 GS  
F 800 GS Adventure

To be fitted and/or enabled in a specialist workshop, and ideally at your BMW Motorrad dealership.

#### PART NUMBERS: F 650 GS

##### Centre stand

Order number: 46 52 7 723 219\*

(+) Centre stand mounting kit

Order number: 71 60 7 706 738\*

#### PART NUMBERS: F 700 GS

##### Centre stand

Order number: 46 52 8 528 636\*

(+) Centre stand mounting kit

Order number: 77 25 8 523 119\*

#### PART NUMBERS: F 800 R

##### Centre stand

Order number: 71 60 7 719 820\*

(+) Centre stand mounting kit

Order number: 71 60 7 720 932\*

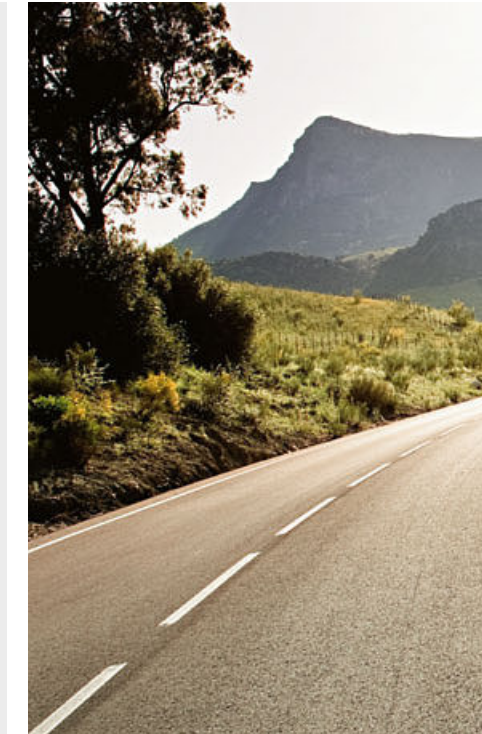

#### PART NUMBERS: F 800 S, F 800 ST

##### Centre stand

Order number: 46 52 7 683 223\*

(+) Centre stand mounting kit

Order number: 77 25 8 523 119\*

#### PART NUMBERS: F 800 GT

##### Centre stand

Order number: 46 52 8 552 109\*

(+) Centre stand mounting kit

Order number: 77 25 8 524 477\*

#### PART NUMBERS: F 800 GS<sup>1</sup>

##### Centre stand

Order number: 46 52 7 700 049\*

(+) Centre stand mounting kit

Order number: 71 60 7 706 738\*

#### PART NUMBERS: F 800 GS<sup>2</sup>, F 800 GS ADVENTURE

##### Centre stand

Order number: 46 52 8 528 637\*

(+) Centre stand attachment

Order number: 77 25 8 523 119\*

<sup>1</sup> Only for model codes 0219, 0229

<sup>2</sup> Only for model codes 0B02, 0B12, 0B07, 0B17



# K MODEL RANGE

## Vehicle-specific accessories for:

K 1200 R  
Model codes 0584, 0594

K 1200 R Sport  
Model codes 0585, 0595

K 1200 S  
Model codes 0581, 0591

K 1200 GT  
Model codes 0587, 0597

K 1300 R  
Model codes 0518, 0519

K 1300 S  
Model codes 0508, 0509

K 1300 GT  
Model codes 0538, 0539

K 1600 GT  
Model codes 0601, 0611

K 1600 GTL  
Model codes 0602, 0612

K 1600 GTL Exclusive  
Model codes 0F02, 0F12

**HP Parts** ————— 338

**Storage** ————— 342

**Design** ————— 348

**Ergonomics & Comfort** ————— 350

**Navigation** ————— 354

**Safety** ————— 355



## HP PARTS



### HP SPORT SILENCER

**AVAILABLE FOR**  
K 1300 R  
K 1300 S

The sleek, high-quality titanium slip-on silencer with carbon end-cap and heat shield trim delivers a powerful rumble. Approx. 1.5 kg lighter than standard silencer.

**PART NUMBER**

**HP sport silencer**  
Order number: 71 60 7 718 438\*



### HP SPORT SILENCER

**AVAILABLE FOR**  
K 1600 GT  
K 1600 GTL  
K 1600 GTL Exclusive

Craftsmanship at its finest: a double-flow slip-on silencer with high-quality conical titanium casing, crossover pipes and mounting system made of stainless steel, plus end-cap made of carbon. With three tailpipes on each side, the BMW K 1600 GT generates a rich, throaty sound to deliver a thrilling riding experience.

**PART NUMBER**

**HP sport silencer**  
Order number: 77 11 8 356 974\*  
(+) HP carbon trim attachment  
Order number: 77 11 8 530 213\*

### HP CARBON COCKPIT INTERIOR PANEL

**AVAILABLE FOR**  
K 1200 S

**PART NUMBERS**

**HP carbon cockpit interior panel, left**  
Order number: 71 60 7 708 492\*  
(+) HP carbon cockpit interior panel, right  
Order number: 71 60 7 708 496\*



(+) = "and" – this item must be ordered at the same time  
(o) = "or" – this item may be ordered as an alternative option



2



### HP CARBON FRONT MUDGUARD

**AVAILABLE FOR**  
K 1200 R  
K 1200 R Sport  
K 1200 S  
K 1300 R  
K 1300 S

**PART NUMBER: K 1200 S, K 1300 S, K 1200 R SPORT**

**HP carbon mudguard, front (image 1)**  
Order number: 71 60 7 708 487\*

**PART NUMBER: K 1200 R, K 1300 R**

**HP carbon mudguard, front (image 2)**  
Order number: 71 60 7 698 745\*



### HP CARBON AIRBOX COVER

**AVAILABLE FOR**  
K 1200 S  
K 1300 S

**PART NUMBER**

**HP carbon airbox cover**  
Order number: 71 60 7 708 497\*

### HP CARBON TANK COVER

**AVAILABLE FOR**  
K 1200 S  
K 1300 S

**PART NUMBER**

**HP carbon tank cover**  
Order number: 71 60 7 715 140\*



2



### HP CARBON CLUTCH COVER

**AVAILABLE FOR**  
K 1200 R  
K 1200 R Sport  
K 1200 S  
K 1300 R  
K 1300 S

The HP carbon clutch cover trim is a larger alternative to the HP carbon clutch cover (only available for certain models). It encases the clutch cover like yarn and adds a touch of exclusivity to the bike when viewed side-on.

**PART NUMBER**

**HP carbon clutch cover (image 1)**  
Order number: 71 60 7 698 748\*

**PART NUMBER: K 1200 R, K 1200 R SPORT, K 1300 R**

**(o) HP carbon clutch cover, large (image 2)**  
Not available in conjunction with HP carbon clutch cover.  
Order number: 71 60 7 716 626\*



### HP CARBON SEAT COVER

#### AVAILABLE FOR

K 1200 R  
K 1200 R Sport  
K 1200 S  
K 1300 R  
K 1300 S

Cannot be combined with pillion comfort seat.



#### PART NUMBERS: K 1200 S, K 1300 S

**HP carbon seat cover** (image 1)  
Order number: 71 60 7 708 483\*

#### PART NUMBERS: K 1200 R, K 1200 R SPORT, K 1300 R

**HP carbon seat cover** (image 2)  
Order number: 71 60 7 698 751\*



### HP CARBON WINDSHIELD

#### AVAILABLE FOR

K 1200 R  
K 1300 R

Replaces standard clear plastic windshield.  
Same design and size as the standard version.

#### PART NUMBERS

**HP carbon windshield**  
Order number: 71 60 7 715 142\*



### HP CARBON AIR INTAKE

#### AVAILABLE FOR

K 1200 R

#### PART NUMBERS

**HP carbon air intake, left**  
Order number: 71 60 7 701 251\*  
(+) HP carbon air intake, right  
Order number: 71 60 7 701 252\*



### HP FORGED WHEEL

#### AVAILABLE FOR

K 1200 R  
K 1200 R Sport  
K 1200 S  
K 1300 R  
K 1300 S

Thanks to the use of lightweight-construction techniques, the HP forged wheels are approx. 1.1kg lighter (per set) than the standard wheels. Reducing the unsprung and rotating mass improves handling and the quality of the suspension.



### HP INSTRUMENT CLUSTER

#### AVAILABLE FOR

K 1200 R  
K 1200 R Sport  
K 1200 S  
K 1300 R  
K 1300 S

The all-weather HP instrument cluster combines the classic BMW display with a host of racetrack-inspired features – a dream addition for all motorsport enthusiasts. To be fitted and/or enabled in a specialist workshop, and ideally at your BMW Motorrad dealership.

#### PART NUMBERS

**HP instrument cluster** (image 1)  
Order number: 62 11 7 719 732\*  
(+) Instrument cluster mounting kit  
Order number: 71 60 7 715 840\*  
(+) Cable harness for instrument cluster  
Order number: 71 60 7 723 833\*  
(+) Auxiliary switch for Set/Menu (image 2)  
Order number: 71 60 7 707 844\*  
(+) ISA screw (two required)  
Order number: 32 72 7 705 874\*



### HP FOOT PEGS

#### AVAILABLE FOR

K 1200 R  
K 1200 R Sport  
K 1200 S  
K 1300 R  
K 1300 S

The HP foot pegs for K 1200 models add both practicality and style. Multiple adjustment options allow riders to create the ergonomic set-up that suits them. Matching HP pillion foot pegs are included in the package.

The HP foot pegs for K 1300 models differ slightly from other variants but offer comparable functionality. HP pillion foot pegs must be ordered separately.

To be fitted and/or enabled in a specialist workshop, and ideally at your BMW Motorrad dealership.



#### PART NUMBERS: K 1200 S, K 1200 R, K 1200 R SPORT

#### HP foot pegs

Order number: 71 60 7 705 037\*

#### PART NUMBERS: K 1300 S, K 1300 R

#### HP rider foot pegs

(image 1)  
Order number: 71 60 7 714 385\*

#### HP pillion passenger foot pegs

(image 2)  
Order number: 71 60 7 720 570\*

### HP CARBON ENGINE SPOILER

#### AVAILABLE FOR

K 1200 R  
K 1200 R Sport  
K 1300 R

#### PART NUMBERS

**HP carbon engine spoiler**  
Order number: 77 31 8 523 196\*





### HP LAP TIMER

**AVAILABLE FOR**  
 K 1200 R  
 K 1200 R Sport  
 K 1200 S  
 K 1300 R  
 K 1300 S

For automatic logging of lap times on the racetrack, with precise breakdowns of individual laps. Only for track use (not homologated for road use). Only available in conjunction with HP instrument cluster.

#### PART NUMBERS

**(+) HP infrared transmitter for lap timer**  
 Order number: 71 60 7 715 836\*  
**(+) HP infrared receiver for lap timer**  
 Order number: 71 60 7 715 830\*



### HP GEAR-SHIFT ASSIST

**AVAILABLE FOR**  
 K 1300 R  
 K 1300 S

The gear-shift assist enables upshifts without throttle release or using the clutch – just like in pro racing. To be fitted and/or enabled in a specialist workshop, and ideally at your BMW Motorrad dealership.

#### PART NUMBERS

**HP gear-shift assist**  
 Order number: 77 25 8 528 775\*  
**(+) Enabling code for gear-shift assist**  
 Order number: 13 61 7 713 379\*

## STORAGE



### SPORT PANNIERS

**AVAILABLE FOR**  
 K 1200 R  
 K 1200 R Sport  
 K 1200 S  
 K 1300 R  
 K 1300 S

Splash-proof sport panniers come with waterproof inner bags (one per pannier). Capacity is adjustable from 15 to 25l on each side – ample room for a helmet in each pannier.

#### PART NUMBERS

**Sport pannier, left**  
 Order number: 71 60 7 723 511\*  
**Sport pannier, right**  
 Order number: 71 60 7 723 512\*  
**(+) Mounting kit (one required per pannier)**  
 Order number: 71 60 7 680 840\*  
**(+) Locking cylinder (with codes) for central locking with motorcycle (one required per pannier)**  
 Order number: 51 25 7 681 200\*

(+) = "and" – this item must be ordered at the same time  
 (o) = "or" – this item may be ordered as an alternative option



### PANNIER RACKS FOR SPORT PANNIERS

**AVAILABLE FOR**  
 K 1200 R  
 K 1200 R Sport  
 K 1200 S  
 K 1300 R  
 K 1300 S

#### PART NUMBERS

**Pannier racks for sport panniers**  
 Order number: 71 60 7 684 618\*  
**(+) Mounting kit for pannier racks**  
 Order number: 71 60 7 680 841\*



### INNER BAG FOR SYSTEM PANNIER

**AVAILABLE FOR**  
 K 1200 GT  
 K 1300 GT

Slipping seamlessly into the overall design of the bike, these inner bags are both stable and lightweight. Handy compartments for small items and carry handles that can be tucked away make them essential travel companions. Left and right are identical

#### PART NUMBER

**Inner bag for system pannier**  
 Order number: 71 60 7 680 543\*



### INNER BAG FOR TOURING PANNIERS

**AVAILABLE FOR**  
 K 1600 GT  
 K 1600 GTL

The tough inner bags make it easier to load and unload the panniers, and are also water-resistant. The practical interior has dividers for holding items in place, and the outer pockets are ideal for small items. With carry handles and detachable shoulder strap.

#### PART NUMBERS

**Inner bag for touring pannier, left (image 1)**  
 Order number: 77 41 8 520 295\*  
**Inner bag for touring pannier, right**  
 Order number: 77 41 8 520 296\*

### PROTECTIVE FILM FOR TOP OF SYSTEM PANNIERS

**AVAILABLE FOR**  
 K 1200 GT  
 K 1300 GT

Self-adhesive, protects pannier paintwork.

#### PART NUMBER

**Protective film for top of system panniers**  
 Order number: 71 60 7 714 329\*



### IMPACT PROTECTION FOR SYSTEM PANNIER

**AVAILABLE FOR**  
 K 1200 GT  
 K 1300 GT

Protects lower area against scratches.

#### PART NUMBERS

**Impact protection system for system pannier, left**  
 Order number: 71 60 7 693 675\*  
**(+) Impact protection system for system pannier, right**  
 Order number: 71 60 7 693 676\*





**IMPACT PROTECTION SYSTEM AND PROTECTIVE FILM FOR TOURING PANNIERS**

**AVAILABLE FOR**

K 1600 GT  
K 1600 GTL  
K 1600 GTL Exclusive

The type of material and design of the protective casing ensure the upper surfaces of the panniers are well protected. The upper casing is wider than the pannier it sits on, so in the event of an impact the casing absorbs the blow and prevents any damage to the painted pannier surface.

The protective film on the lower half prevents unsightly scratches.

**PART NUMBERS**

**Impact protection system for touring pannier, left**  
Order number: 77 42 7 700 461\*

**Impact protection system for touring pannier, right**  
Order number: 77 42 7 700 462\*

**Protective film for top of touring panniers**  
Order number: 77 42 8 528 355\*



**INNER BAG FOR EXCLUSIVE TOURING PANNIERS**

**AVAILABLE FOR**

K 1600 GT  
K 1600 GTL  
K 1600 GTL Exclusive

Inner bags made to match the exclusive design of the limited-edition model.

**PART NUMBERS**

**Inner bag for Exclusive touring pannier, left**  
Order number: 46 54 8 549 365\*

**Inner bag for Exclusive touring pannier, right**  
Order number: 46 54 8 549 366\*

**TOURING TOP BOX**

**AVAILABLE FOR**

K 1600 GT

The waterproof top box with build-in backrest pad for the pillion passenger has an interior light and a velours lining, and takes minimal effort to open. It has a capacity of approximately 49l – plenty of space for two helmets, for example. Available in all current paint colours



**SMALL TOP BOX, 28l**

**AVAILABLE FOR**

K 1200 GT  
K 1300 GT

The waterproof top box is easy to mount on the luggage grid and has enough space inside for a helmet.

**PART NUMBERS**

**Top box, 28l**  
Order number: 77 43 7 724 352\*

(+) Locking cylinder (with codes) for central locking with motorcycle  
Order number: 51 25 7 681 200\*

**PART NUMBERS**

**Touring top box, Dark Graphite Metallic**  
Order number: 77 43 7 719 809\*

(o) Touring top box, Sakhir Orange Metallic  
Order number: 77 43 8 537 615\*

(o) Touring top box, Light White  
Order number: 77 43 8 534 257\*

(o) Touring top box, Black Storm Metallic  
Order number: 77 43 8 553 921\*

(o) Touring top box, Light Grey Metallic  
Order number: 77 43 8 526 375\*

(o) Touring top box, Vermilion Red Metallic  
Order number: 77 43 8 526 376\*

(o) Touring top box, Montego Blue Metallic  
Order number: 77 43 7 710 698\*

(o) Touring top box, Mars Red Metallic  
Order number: 77 43 8 565 872\*

(o) Touring top box, Lupin Blue Metallic  
Order number: 46 54 8 567 662\*

(+) Locking cylinder (with codes) for central locking with motorcycle  
Order number: 51 25 7 681 200\*

(+) = "and" – this item must be ordered at the same time  
(o) = "or" – this item may be ordered as an alternative option



**INNER BAG FOR SMALL TOP BOX, 28L**

**AVAILABLE FOR**

K 1200 GT  
K 1300 GT

Slipping seamlessly into the overall design of the bike, these inner bags are both sturdy and lightweight. Handy compartments for small items and carry handles that can be tucked away make them essential travel companions.

**PART NUMBER**

**Inner bag for top box, 28l**  
Order number: 71 60 7 680 541\*



**INNER BAG FOR TOURING TOP BOX**

**AVAILABLE FOR**

K 1600 GT  
K 1600 GTL

The handy, high-quality inner bag is water-resistant and makes full use of the capacity of the top box. So while the inner bag is being used, space within the storage compartment for the top box will be limited.

**PART NUMBER**

**Inner bag for top box**  
Order number: 77 41 8 520 301\*

**INNER BAG FOR EXCLUSIVE TOURING TOP BOX**

**AVAILABLE FOR**

K 1600 GT  
K 1600 GTL  
K 1600 GTL Exclusive

An inner bag made to match the exclusive design of the limited-edition model.

**PART NUMBER**

**Inner bag for Exclusive top box**  
Order number: 46 54 8 549 364\*



**INNER BAG FOR TOP BOX, 49l**

**AVAILABLE FOR**

K 1200 GT  
K 1300 GT

Slipping seamlessly into the overall design of the bike, these inner bags are both sturdy and lightweight. Handy compartments for small items and carry handles that can be tucked away make them essential travel companions.

**PART NUMBER**

**Inner bag for top box, 49l**  
Order number: 71 60 7 680 542\*



**LARGE TOP BOX, WHITE ALUMINIUM, 49l**

**AVAILABLE FOR**

K 1200 GT  
K 1300 GT

The waterproof top box is easy to mount on the luggage grid and has enough space inside for up to two helmets.

**PART NUMBERS**

**Large top box, White Aluminium, 49 l**  
Order number: 71 60 7 720 456\*

(+) Locking cylinder (with codes) for central locking with motorcycle  
Order number: 51 25 7 681 200\*

\* Original BMW Motorrad equipment is available from your BMW Motorrad dealer.



### STORAGE COMPARTMENT FOR TOURING TOP BOX

#### AVAILABLE FOR

K 1600 GT  
K 1600 GTL  
K 1600 GTL Exclusive

The perfect solution for documents, stationery or even your tablet: this handy compartment has four quick-release fasteners for attaching to the lid of the top box, and helps keep things tidy while providing ready access to all your vital bits and pieces.

#### PART NUMBER

**Storage compartment for top box**  
Order number: 77 41 8 520 303\*



### TANKBAG

#### AVAILABLE FOR

K 1200 R  
K 1200 R Sport  
K 1300 R

Waterproof tankbag with waterproof main compartment and map pocket and a capacity that expands from 13 to 20l. Sturdy construction and materials ensure everything stays in place, even when the bike is moving at high speed. Cannot be used when BMW Motorrad Navigator is fitted.

#### PART NUMBER

**Tankbag**  
Order number: 71 60 7 712 408\*



### TANKBAG

#### AVAILABLE FOR

K 1200 GT  
K 1300 GT

A waterproof tankbag with main compartment designed with the ergonomic set-up of sport bike riders in mind. Capacity expands from 13 to 20l via an all-round zip.

#### PART NUMBER

**Tankbag**  
Order number: 77 45 8 527 537\*

### LARGE TANKBAG

#### AVAILABLE FOR

K 1200 S  
K 1300 S

Waterproof tankbag with waterproof main compartment and map pocket and a capacity that expands from 13 to 20l. Sturdy construction and materials ensure everything stays in place, even when the bike is moving at speed. Cannot be used when BMW Motorrad Navigator is fitted.

#### PART NUMBER

**Large tankbag**  
Order number: 71 60 7 712 395\*



### SMALL TANKBAG (NOT SHOWN)

#### AVAILABLE FOR

K 1200 S  
K 1300 S

The small, 10l tankbag is flatter, giving it a more dynamic look, and provides both an unobstructed view of the instrument panel (particularly for shorter riders) and greater freedom of movement on the bike, i.e. for leaning over the tank while on the motorway. Cannot be used when BMW Motorrad Navigator is fitted.

#### PART NUMBER

**Small tankbag**  
Order number: 77 45 7 724 606\*



### UNIVERSAL TANKBAG

#### AVAILABLE FOR

K 1200 R  
K 1200 R Sport  
K 1200 S  
K 1300 R  
K 1300 S

A waterproof tankbag with waterproof main compartment. Fits various BMW Motorrad models. Capacity expands from approx. 10 to 12l. Can be combined with BMW Motorrad Navigator systems.

#### PART NUMBER

**Universal tankbag**  
Order number: 77 49 7 726 994\*

#### ALSO FOR K 1200 S, K 1300 S

(+) Attachment for tankbag, front  
Order number: 71 60 7 712 398\*

(+) Attachment for tankbag, rear  
Order number: 71 60 7 712 397\*

#### ALSO FOR K 1200 R, K 1200 R SPORT, K 1300 R

(+) Attachment for tankbag, front  
Order number: 71 60 7 712 416\*

(+) Universal tankbag attachment  
Order number: 77 49 7 727 287\*

### TANKBAG

#### AVAILABLE FOR

K 1600 GT

The watertight main compartment of the tankbag can be expanded from 10 to 12l and features a small transparent window with a cradle for mobile phones. Also includes two exterior pockets and one interior pocket for stowing small items securely. With carry handle and detachable shoulder strap.



### TANKBAG

#### AVAILABLE FOR

K 1200 R  
K 1200 R Sport  
K 1200 S  
K 1300 R  
K 1300 S

This tankbag has a large waterproof main compartment (approx. 12l) and a pocket (with window) for smaller items. It fits various BMW Motorrad models and can be combined with BMW Motorrad Navigator systems.

#### PART NUMBER

**Tankbag**  
Order number: 71 60 7 691 391\*

#### ALSO FOR 1200 S, K 1300 S

(+) Tankbag attachment  
Order number: 71 60 7 690 753\*

#### ALSO FOR 1200 R, K 1200 R SPORT, K 1300 R

(+) Tankbag attachment  
Order number: 71 60 7 694 120\*



### LUGGAGE GRID

#### AVAILABLE FOR

K 1200 R  
K 1200 R Sport  
K 1200 S  
K 1300 R  
K 1300 S

#### PART NUMBER: K 1200 S, K 1300 S

**Luggage grid**  
Order number: 71 60 7 715 137\*

#### PART NUMBER: K 1200 R, K 1200 R SPORT, K 1300 R

**Luggage grid** (not shown)  
Order number: 46 54 7 674 066\*



## DESIGN



### LED REAR LIGHT

#### AVAILABLE FOR

K 1200 R  
K 1200 R Sport  
K 1200 S

Sleek rear lights with state-of-the-art LED technology fuse style with technical wizardry. Practically wear-free, they increase safety in road traffic.

Note differences in national-market specifications.

To be fitted and/or enabled in a specialist workshop, and ideally at your BMW Motorrad dealership.

#### PART NUMBERS

##### LED rear light

Order number: 63 21 8 526 957\*

(+) Raised head screw

Order number: 60 32 7 657 966\*

(+) Cable harness for rear light

Order number: 61 12 7 702 078\*

### LED INDICATORS

#### AVAILABLE FOR

K 1200 R  
K 1200 R Sport  
K 1300 R

Cutting-edge design inside and out. The LED indicators deliver significantly longer bulb life – a shining example of efficiency.

To be fitted and/or enabled in a specialist workshop, and ideally at your BMW Motorrad dealership.



#### PART NUMBERS

**LED indicators, front** (two required)

Order number: 63 13 8 522 499\*

(+) LED indicators, rear (two required)

Order number: 63 23 8 522 500\*

(+) Adapter cable for LED indicators

Order number: 71 60 7 711 284\*

(+) = "and" – this item must be ordered at the same time  
(o) = "or" – this item may be ordered as an alternative option



### CHROME PARTS

#### AVAILABLE FOR

K 1600 GT  
K 1600 GTL  
K 1600 GTL Exclusive

Choose the look you want: these elegant, high-quality chrome parts can be combined as you wish, giving your BMW K 1600 GT a unique, stylish edge.

To be fitted and/or enabled in a specialist workshop, and ideally at your BMW Motorrad dealership.

#### PART NUMBERS: K 1600 GT

**Chrome-plated windshield trim, left** (image 1)

Order number: 46 63 7 727 403\*

(+) Chrome-plated windshield trim, right

Order number: 46 63 7 727 404\*

(+) Raised flange head screw (two required)

Order number: 06 32 7 651 212\*

**Chrome-plated slipstream deflector, left** (image 2)

Order number: 46 63 7 727 535\*

(+) Chrome-plated slipstream deflector, right

Order number: 46 63 7 727 536\*

**Chrome-plated coolant-hose cover** (image 3)

Order number: 46 63 7 727 366\*

**Chrome-plated pannier trim, left** (image 4)

Order number: 51 14 8 545 123\*

(+) Chrome-plated pannier trim, right

Order number: 51 14 8 545 124\*

**Chrome-plated top box lid trim** (image 5)

Order number: 46 54 8 522 938\*

#### PART NUMBERS: K 1600 GT, K 1600 GTL,

#### K 1600 GTL EXCLUSIVE

**Chrome-plated expansion tank cap, left** (image 6)

Order number: 32 72 8 543 781\*

(+) Chrome-plated expansion tank cap, right

Order number: 32 72 8 543 782\*

## ERGONOMICS & COMFORT



### TINTED WINDSHIELD

**AVAILABLE FOR**  
K 1200 R Sport  
K 1200 S  
K 1300 S

The tinted windshield gives the bike a sportier look. Same design and size as the clear windshield.

**PART NUMBER: K 1200 S, K 1300 S**

**Tinted windshield** (image 1)  
Order number: 71 60 7 698 097

**PART NUMBER: K 1200 R SPORT**

**Tinted windshield** (image 2)  
Order number: 71 60 7 705 178



### SPORT WINDSHIELD, TINTED

**AVAILABLE FOR**  
K 1200 R  
K 1300 R

The tinted windshield improves protection from the elements.

**PART NUMBER: K 1200 R**

**Sport windshield, tinted** (not shown)  
Order number: 46 63 7 686 637\*

**PART NUMBER: K 1300 R**

**Sport windshield, tinted**  
Order number: 46 63 7 714 614\*

#### ALSO

(+) Mounting parts for sport windshield  
Order number: 46 63 7 674 065\*



### SEAT IN BLACK

**AVAILABLE FOR**  
K 1200 R  
K 1200 R Sport  
K 1200 S  
K 1300 R  
K 1300 S

**PART NUMBERS: K 1200 S, K 1300 S**

**Low seat, Black** (not shown)  
Seat height: 790mm, step length: 1,750mm  
Order number: 52 53 8 528 326\*

**Seat, Black** (not shown)  
Seat height: 820mm, step length: 1,810mm  
Order number: 52 53 8 522 289\*

**PART NUMBERS: K 1200 R, K 1200 R SPORT, K 1300 R**

**Low seat, Black** (see image)  
Seat height: 790mm, step length: 1,750mm  
Order number: 52 53 7 686 626\*

**Seat, Black** (see image)  
Seat height: 820mm, step length: 1,810mm  
Order number: 52 53 7 686 625\*



### PILLION COMFORT SEAT

**AVAILABLE FOR**  
K 1200 R  
K 1200 R Sport  
K 1300 R

Increases pillion passenger comfort and makes the bike even more of an all-rounder. The pillion area is significantly wider and more padded than the standard seat (rider section unchanged).  
Not available in conjunction with HP carbon seat cover.

**PART NUMBER**

**Pillion comfort seat**  
Order number: 52 53 7 709 574\*

### LARGE WINDSHIELD

**AVAILABLE FOR**  
K 1200 GT  
K 1300 GT

Providing the rider with even better protection from wind and rain, the large windshield is ideal for longer tours. To be fitted and/or enabled in a specialist workshop, and ideally at your BMW Motorrad dealership.

**PART NUMBER**

**Large windshield**  
Order number: 71 60 7 699 600\*



### LOW WINDSHIELD

**AVAILABLE FOR**  
K 1600 GT  
K 1600 GTL  
K 1600 GTL Exclusive

The low windshield gives the bike a sportier look. To be fitted and/or enabled in a specialist workshop, and ideally at your BMW Motorrad dealership.

**PART NUMBER**

**Low windshield**  
Order number: 77 33 8 528 329

(+) Raised flange head screw (four required)  
Order number: 06 32 7 651 212



### COMFORT WINDSHIELD

**AVAILABLE FOR**  
K 1600 GT  
K 1600 GTL  
K 1600 GTL Exclusive

The standard GTL windshield on the GT provides the rider with even better protection from wind and rain, making it ideal for longer tours.

**PART NUMBER**

**Comfort windshield**  
Order number: 77 33 7 724 350

(+) Body panel screw without flange (four required)  
Order number: 46 63 8 534 938



### GT WINDSHIELD

**AVAILABLE FOR**  
K 1600 GTL  
K 1600 GTL Exclusive

The GT windshield accentuates the dynamic contours of the GTL.  
To be fitted and/or enabled in a specialist workshop, and ideally at your BMW Motorrad dealership.

**PART NUMBER**

**GT windshield**  
Order number: 46 63 7 709 513\*  
(+) Raised flange head screw (four required)  
Order number: 06 32 7 651 212





### ONE-PIECE SEAT

**AVAILABLE FOR**  
K 1600 GT  
K 1600 GTL

#### PART NUMBERS

##### One-piece low seat

Seat height: 750 mm, step length: 1,720 mm  
Order number: 52 53 7 729 321\*

##### One-piece seat (not shown)

Seat height: 780 mm, step length: 1,770 mm  
Order number: 52 53 7 718 500\*

##### One-piece high seat (not shown)

Seat height: 810 mm, step length: 1,830 mm  
Order number: 52 53 8 545 128\*

#### ALSO FOR K 1600 GT

(+) One-piece seat mounting kit  
Order number: 77 34 8 52 027\*

### LOW RIDER SEAT

**AVAILABLE FOR**  
K 1200 GT  
K 1300 GT

Seat height: 800/820 mm; step length:  
1,760/1,800 mm



### HEIGHT-ADJUSTABLE RIDER SEAT

**AVAILABLE FOR**  
K 1600 GT  
K 1600 GTL

#### PART NUMBERS

##### Height-adjustable low rider seat

Seat height: 780/800 mm; step length:  
1,775/1,810 mm  
Order number: 52 53 7 712 118\*

##### Height-adjustable rider seat (not shown)

Seat height: 810/830 mm; step length:  
1,830/1,870 mm  
Order number: 52 53 7 716 435\*

#### ALSO FOR K 1600 GTL

(+) Seat installation kit  
Order number: 77 34 8 52 028\*

(+) Connecting cable for seat  
Order number: 61 12 8 528 423\*

(+) Pillion seat  
Order number: 52 53 7 712 119\*

#### PART NUMBERS

##### Low rider seat, Black

Order number: 52 53 7 704 834\*

(o) Low rider seat, heated, Black  
Order number: 52 53 7 704 832\*

##### Low rider seat, Grey

Order number: 52 53 7 704 835\*

(o) Low rider seat, heated, Grey  
Order number: 52 53 7 704 833\*



### ARMRESTS FOR PILLION PASSENGER

**AVAILABLE FOR**  
K 1600 GTL

Padded armrests provide more comfort for the pillion passenger and are ergonomically designed to complement the standard top box backrest. They also fold up, making it easier for the pillion passenger to climb on and off.

To be fitted and/or enabled in a specialist workshop, and ideally at your BMW Motorrad dealership.

For more detailed information, contact your BMW Motorrad dealership or go online at [bmw-motorrad.com](http://bmw-motorrad.com)

#### PART NUMBERS

##### Armrests for pillion passenger

Order number: 77 25 8 524 692\*

(+) Attachments for pillion armrests  
Order number: 77 25 8 529 212\*

(+) Padding for pillion armrests  
Order number: 77 25 8 529 864\*

(+) Pillion armrest cover, Magnesium Beige, left  
Order number: 46 62 8 544 345\*

(+) Pillion armrest cover, Magnesium Beige, right  
Order number: 46 62 8 544 346\*

(o) Pillion armrest cover, Glacier Silver, left  
Order number: 77 25 8 528 937\*

(o) Pillion armrest cover, Glacier Silver, right  
Order number: 77 25 8 528 938\*

(+) = "and" – this item must be ordered at the same time  
(o) = "or" – this item may be ordered as an alternative option

### HEATED GRIPS (NOT SHOWN)

#### AVAILABLE FOR

K 1200 R  
K 1200 R Sport  
K 1200 S  
K 1200 GT  
K 1300 R  
K 1300 S  
K 1300 GT

Keep your hands as warm as you like with retrofittable heated grips.

To be fitted and/or enabled in a specialist workshop, and ideally at your BMW Motorrad dealership.

For more detailed information, contact your BMW Motorrad dealership or go online at [bmw-motorrad.com](http://bmw-motorrad.com)

#### PART NUMBERS: K 1200 S, K 1200 R, K 1200 R SPORT

##### Heated grip, left

Order number: 61 31 7 727 067\*

##### (+) Heated grip, right

Order number: 61 31 7 708 286\*

##### (+) Multifunction switch for heated grip, right

Order number: 61 31 7 694 982\*

##### (+) Raised head screw with flange (two required)

Order number: 61 31 7 682 091\*

#### PART NUMBERS: K 1300 S, K 1300 R, K 1300 GT

##### Heated grip, left

Order number: 61 31 7 708 227\*

##### (+) Heated grip, right

Order number: 61 31 7 708 228\*

##### (+) Multifunction switch for heated grips

Order number: 61 31 8 546 170\*

##### (o) Multifunction switch for heated grips and seat heating

Order number: 61 31 8 546 174\*

##### (+) Multifunction switch cover, right

Order number: 61 31 7 708 231\*

##### (+) Raised countersunk screw (two required)

Order number: 07 11 9 906 567\*

#### PART NUMBERS: K 1200 GT

##### Heated grip, left

Order number: 61 31 7 708 334\*

##### (+) Heated grip, right

Order number: 61 31 7 694 813\*

##### (+) Multifunction switch for heated grips

Order number: 61 31 7 708 334\*

##### (o) Multifunction switch for heated grips and seat heating

Order number: 61 31 7 708 336\*

##### (o) Multifunction switch for heated grips and on-board computer

Order number: 61 31 7 708 332\*

##### (o) Multifunction switch for heated grips, seat heating and on-board computer

Order number: 61 31 7 708 340\*

##### (+) Self-tapping screw (two required)

Order number: 07 11 9 901 268\*

### COMFORT FOOT PEGS, MAGNESIUM MATT (NOT SHOWN)

#### AVAILABLE FOR

K 1600 GT

To be fitted and/or enabled in a specialist workshop, and ideally at your BMW Motorrad dealership.

#### PART NUMBERS

##### Comfort foot peg, Magnesium Matt, front left

Order number: 46 71 7 728 865\*

##### (+) Comfort foot peg, Magnesium Matt, front right

Order number: 46 71 7 728 866\*

##### (+) Comfort foot peg, Magnesium Matt, rear left

Order number: 46 71 7 728 871\*

##### (+) Comfort foot peg, Magnesium Matt, rear right

Order number: 46 71 7 728 872\*

### HILL START CONTROL RETROFIT

#### AVAILABLE FOR

K 1600 GT

K 1600 GTL

K 1600 GTL Exclusive

To be fitted and/or enabled in a specialist workshop, and ideally at your BMW Motorrad dealership.

For more detailed information, contact your BMW Motorrad dealership or go online at [bmw-motorrad.com](http://bmw-motorrad.com)

#### PART NUMBER

##### Hill Start Control retrofit

Order number: 77 23 8 536 874\*



### LED GROUND-LEVEL LIGHTING

**AVAILABLE FOR**  
K 1600 GT  
K 1600 GTL

LED lights that illuminate the ground beneath the bike, making it easier to find a stable spot to prop up the centre/side stand and the motorcycle itself.

Not approved for all countries, observe the regulations specific to your country.

To be fitted and/or enabled in a specialist workshop, and ideally at your BMW Motorrad dealership.

For more detailed information, contact your BMW Motorrad dealership or go online at [bmw-motorrad.com](http://bmw-motorrad.com)

#### PART NUMBERS

##### LED ground-level lighting

Order number: 63 17 7 727 584\*

## NAVIGATION



### BMW MOTORRAD NAVIGATION SYSTEMS

#### AVAILABLE FOR

K 1200 R  
K 1200 R Sport  
K 1200 S  
K 1200 GT  
K 1300 R  
K 1300 S  
K 1300 GT  
K 1600 GT  
K 1600 GTL  
K 1600 GTL Exclusive

Where am I? Where do I want to go, and what's the most scenic way to get there?

BMW Motorrad navigation devices show you where to go. Made specifically for motorcyclists, they're easy to fit and use – even with gloves on – and come with lifetime map updates.

The new BMW Motorrad Navigator VI is your ticket to the tour of your dreams. A whole new level of adventure awaits thanks to the “winding roads” route option, “avoid motorways” feature and the “round trip” function, which configures journeys based on time, distance or stopover. The circular polarization filter (CPOL) on the display minimizes reflection and improves contrast, ensuring the screen is easy to read, even in direct sunlight. 16 GB of flash storage, and the ability to stream music from your smartphone, are the ultimate luxury.

Thanks to Bluetooth® technology, the sophisticated BMW Motorrad Navigator Street (with easy-to-read 4.3" display) is compatible with the optional BMW Motorrad communication system and comes with a host of handy features.

Note differences in national-market specifications.

For more detailed information, contact your BMW Motorrad dealership or go online at [bmw-motorrad.com](http://bmw-motorrad.com)

#### PART NUMBERS: K 1600 GT, K 1600 GTL, K 1600 GTL EXCLUSIVE

Only available in conjunction with navigation device preparation.

#### BMW Motorrad Navigator VI (EU) (image 1)

Order number: 77 52 8 355 994

#### BMW Motorrad Navigator VI (US) (image 1)

Order number: 77 52 8 355 998

#### PART NUMBER: K 1200 R, K 1200 R SPORT, K 1200 S, K 1200 GT, K 1300 R, K 1300 S, K 1300 GT

#### BMW Motorrad Navigator VI (EU) (image 2)

Order number: 77 52 8 355 749

#### BMW Motorrad Navigator VI (US) (image 2)

Order number: 77 52 8 355 829

#### BMW Motorrad Navigator Street (EU) (image 4)

Order number: 77 52 8 557 855

#### BMW Motorrad Navigator Street (US) (image 4)

Order number: 77 52 8 557 856

#### BMW Motorrad smartphone cradle (image 3)

Order number: 77 52 8 563 125

### BRACKET FOR BMW MOTORRAD NAVIGATION SYSTEMS (NOT SHOWN)

#### AVAILABLE FOR

K 1200 R  
K 1200 R Sport  
K 1200 S  
K 1300 R  
K 1300 S  
K 1200 GT  
K 1300 GT

Bracket for mounting BMW Motorrad navigation devices. Guarantees a good view of the navigation system.

#### PART NUMBER: K 1200 R, K 1200 R SPORT, K 1200 S, K 1300 R, K 1300 S

#### Bracket for BMW Motorrad navigation devices

Order number: 71 60 7 676 948

#### (+) Base plate kit for Navigator

Order number: 71 60 7 687 728

#### (+) Base plate kit for Navigator

Order number: 71 60 7 687 769

#### PART NUMBER: K 1200 GT, K 1300 GT

#### Bracket for BMW Motorrad navigation devices

Order number: 71 60 7 676 868

## SAFETY

### AUDIO SYSTEM CONTROL UNIT (NOT SHOWN)

#### AVAILABLE FOR

K 1600 GT

To be fitted and/or enabled in a specialist workshop, and ideally at your BMW Motorrad dealership.

For more detailed information, contact your BMW Motorrad dealership or go online at [bmw-motorrad.com](http://bmw-motorrad.com)

Only available in conjunction with audio system and navigation device preparation.

#### PART NUMBERS

#### Audio system control panel

Order number: 65 14 7 727 885

#### (+) Audio control unit

Order number: 65 12 8 542 064

#### (+) Audio control unit

Order number: 65 12 8 542 065

#### (+) Left bracket

Order number: 65 12 7 728 252

#### (+) Right bracket

Order number: 65 12 7 728 252

#### (+) Blind rivet nut, flat head (four required)

Order number: 46 63 2 347 012

#### (+) Thread cutting screw (two required)

Order number: 07 14 7 698 893

#### (+) Raised head screw (six required)

Order number: 06 32 7 657 966



### ANTI-THEFT ALARM SYSTEM (NOT SHOWN)

#### AVAILABLE FOR

K 1200 S  
K 1200 R  
K 1200 R Sport  
K 1200 GT  
K 1300 S  
K 1300 R  
K 1300 GT  
K 1600 GT  
K 1600 GTL  
K 1600 GTL Exclusive

If the motorcycle is moved or struck violently, the system responds with a clearly audible signal and a flashing warning light.

To be fitted and/or enabled in a specialist workshop, and ideally at your BMW Motorrad dealership.

#### PART NUMBER: K 1200 R, K 1200 R SPORT, K 1200 S, K 1200 GT, K 1300 R, K 1300 S, K 1300 GT

#### Anti-theft alarm system with remote control

Order number: 77 53 8 545 003

#### (+) Resistor

Order number: 61 13 7 668 405

#### (+) Battery

Order number: 65 75 2 337 504

#### PART NUMBERS: K 1600 GT, K 1600 GTL, K 1600 GTL EXCLUSIVE

#### Anti-theft alarm system retrofit

Order number: 77 53 8 554 348

#### (+) Raised head screw with washer (three required)

Order number: 07 14 9 141 517



### ENGINE PROTECTION BAR

#### AVAILABLE FOR

K 1600 GT  
K 1600 GTL

In situations where impacts are unavoidable, the engine protection bar helps prevent damage to the engine.

#### PART NUMBER

**Engine protection bar**  
Order number: 77 14 8 535 326



### CENTRE STAND

#### AVAILABLE FOR

K 1200 R  
K 1200 R Sport  
K 1200 S  
K 1300 R  
K 1300 S

#### PART NUMBERS

**Centre stand**  
Order number: 46 52 7 704 612

#### ALSO FOR K 1200 R, K 1200 R SPORT, K 1200 S

(+) Mounting parts for centre stand  
Order number: 77 25 7 726 045

#### ALSO FOR K 1300 R, K 1300 S

(+) Mounting parts for centre stand  
Order number: 71 60 7 691 855



### ADDITIONAL BRAKE LIGHT FOR TOURING TOP BOX

#### AVAILABLE FOR

K 1600 GT  
K 1600 GTL

Practically wear-free, the additional brake light increases safety in road traffic. A cluster of 16 LEDs clearly signals when the brakes are applied, greatly reducing the risk of a collision.

To be fitted and/or enabled in a specialist workshop, and ideally at your BMW Motorrad dealership.

#### PART NUMBER

**Additional brake light for touring top box**  
Order number: 77 51 8 520 044



\* Original BMW Motorrad equipment is available from your BMW Motorrad dealer.

# S MODEL RANGE

## Vehicle-specific accessories for:

S 1000 R  
Model codes 0D02, 0D12, 0D32

S 1000 RR  
Model codes 0507, 0517, 0524 (MÜ), 0534 (MÜ),  
0D10 (MÜ2), 0D21 (MÜ2)

HP4  
Model codes 0D01, 0D11

HP Parts	360
Storage	374
Design	375
Ergonomics & Comfort	378
Navigation	380
Safety	381



## HP PARTS



### HP SPORT SILENCER

**AVAILABLE FOR**  
S 1000 R  
S 1000 RR

The sleek, high-quality titanium slip-on silencer with carbon end-cap and large carbon heat shield trim delivers a powerful rumble.

**PART NUMBER: S 1000 RR<sup>1</sup>, S 1000 R**

**HP sport silencer** (image 1)  
Order number: 77 11 7 723 814\*  
Approx. 0.5kg lighter than standard silencer.

**PART NUMBER: S 1000 RR<sup>2</sup>**

**HP sport silencer** (image 2)  
Order number: 77 11 8 554 206\*  
Approx. 1.8kg lighter than standard silencer.

<sup>1</sup> Only for model codes 0507, 0517, 0524, 0534

<sup>2</sup> Only for model codes 0D10, 0D21, 0D40

### HP TITANIUM EXHAUST SYSTEM

**AVAILABLE FOR**  
S 1000 RR

The complete titanium exhaust system is approx. 5.7kg lighter than the standard exhaust. Custom parameters for engine management increase performance primarily in the mid rev range.

To be fitted and/or enabled in a specialist workshop, and ideally at your BMW Motorrad dealership.

For more detailed information, contact your BMW Motorrad dealership or go online at [bmw-motorrad.com](http://bmw-motorrad.com)  
Only for model codes 0507, 0517, 0524, 0534\*

**PART NUMBERS: S 1000 RR**

**HP titanium exhaust system**  
Order number: 77 11 8 529 218

(+) FSC sport exhaust system retrofit  
Order number: 13 61 8 531 006

(+) Bowden activating cable  
Order number: 77 11 8 529 464

(+) Bowden release cable  
Order number: 77 11 8 529 465

(+) End cap  
Order number: 12 52 7 700 428

(+) Hexagon screw  
Order number: 07 11 9 902 910

(+) Washer  
Order number: 07 11 9 904 164

(+) Collar nut, self-locking  
Order number: 07 11 9 905 374

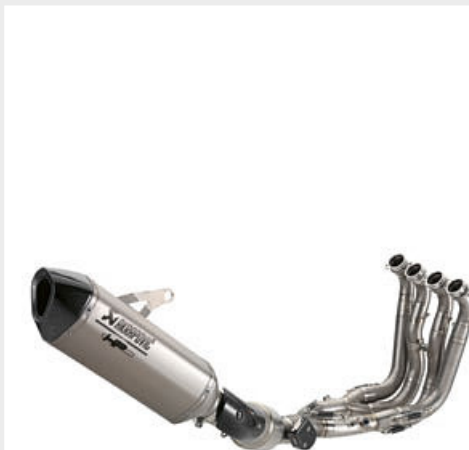

### HP TITANIUM EXHAUST SYSTEM

**AVAILABLE FOR**  
S 1000 R  
S 1000 RR

The titanium exhaust system is 3.7kg (S 1000 RR MÜ2) or 5kg (S 1000 R) lighter than the standard exhaust. Custom parameters for engine management increase performance primarily in the mid rev range.

To be fitted and/or enabled in a specialist workshop, and ideally at your BMW Motorrad dealership.

For more detailed information, contact your BMW Motorrad dealership or go online at [bmw-motorrad.com](http://bmw-motorrad.com)

**PART NUMBERS: S 1000 R**

**HP titanium exhaust system**

Order number: 77 11 8 546 045\*

(+) Enabling code for HP titanium exhaust system

Order number: 13 61 8 531 006\*

(+) Bowden activating cable

Order number: 77 11 8 546 400\*

(+) Bowden release cable

Order number: 77 11 8 546 401\*

(+) End cap

Order number: 12 52 7 700 428\*

(+) Exhaust manifold gasket (four required)

Order number: 18 51 8 542 088\*

(o) Engine spoiler heat shield (two required)

Order number: 77 31 8 553 713\*

**PART NUMBERS: S 1000 RR**

**HP titanium exhaust system**

Order number: 77 11 8 549 354

(+) FSC sport exhaust system retrofit

Order number: 13 61 8 531 006

(+) Bowden activating cable

Order number: 77 11 8 546 400

(+) Bowden release cable

Order number: 77 11 8 546 401

(+) End cap

Order number: 12 52 7 700 428

(+) Heat shield for engine spoiler

Order number: 77 31 8 551 213



**PART NUMBERS: S 1000 RR**

**HP power kit**

Order number: 77 11 8 521 685

(+) Controller

Order number: 13 61 8 543 376

(+) FSC HP power kit

Order number: 13 61 8 522 450

(+) Exhaust manifold gasket (four required)

Order number: 18 21 7 717 848

(+) End cap (two required)

Order number: 61 13 7 702 398

(+) End cap (two required)

Order number: 12 52 7 700 428

**HP power kit (see image)**

Order number: 77 11 8 554 955

(+) FSC HP power kit

Order number: 13 61 8 522 450

(+) End cap (two required)

Order number: 61 13 7 702 398

(+) End cap (two required)

Order number: 12 52 7 700 428

(+) Heat shield for engine spoiler

Order number: 77 31 8 551 213

(+) ISA screw

Order number: 07 12 9 907 402

(+) Multifunction switch, left

Order number: 61 31 8 549 067

### HP POWER KIT

**AVAILABLE FOR**  
S 1000 RR  
HP4

When combined with the HP titanium exhaust system, the HP power kit dramatically reduces weight and increases performance. Ideal for high-level racetrack riders and private racing teams.

For more detailed information, contact your BMW Motorrad dealership or go online at [bmw-motorrad.com](http://bmw-motorrad.com)

To be fitted and/or enabled in a specialist workshop, and ideally at your BMW Motorrad dealership.

Only for track use (not homologated for road use).

(o) Multifunction switch, left

Order number: 61 31 8 549 065

(+) Rate sensor

Order number: 61 35 8 388 688

(+) C-clip nut, self-locking

Order number: 07 14 7 286 036

**PART NUMBERS: HP4**

**Connecting tube for HP power kit**

Order number: 77 11 8 521 688

(+) Controller

Order number: 13 61 8 543 376

(+) FSC HP power kit

Order number: 13 61 8 522 450

(+) Connecting tube attachment

Order number: 77 11 8 521 695

(+) End cap

Order number: 61 13 7 702 398

(+) End cap (two required)

Order number: 12 52 7 700 428



### FOLDING HP HAND LEVERS

#### AVAILABLE FOR

S 1000 RR  
Only for model codes 0507, 0517, 0524, 0534  
HP4

High-quality, titanium-anodized, CNC-milled aluminium hand levers allow riders to adjust the distance between the handlebar grip and the hand lever itself. A folding mechanism reduces the danger of the lever bending or braking in the event of a crash.

To be fitted and/or enabled in a specialist workshop, and ideally at your BMW Motorrad dealership.

#### PART NUMBERS

##### Folding HP brake levers

Order number: 77 22 7 727 756

(+) Folding HP clutch lever

Order number: 77 22 7 727 755

(+) Clutch lever switch

Order number: 77 22 8 521 146



### FOLDING HP HAND LEVERS

#### AVAILABLE FOR

S 1000 RR  
S 1000 RR  
Only for model codes 0D10, 0D21

High-quality, titanium-anodized, CNC-milled aluminium hand levers allow riders to adjust the distance between the handlebar grip and the hand lever. A folding mechanism reduces the danger of the lever bending or braking in the event of a crash.

Successfully tested on the racetrack before market launch, the brake lever allows riders to adjust the distance between the handlebar grip and the hand lever itself.

A roller wheel on the left handlebar allows adjustment of brake lever play when the bike's centre of pressure shifts.

To be fitted and/or enabled in a specialist workshop, and ideally at your BMW Motorrad dealership.

#### PART NUMBERS

##### Folding HP brake levers

Order number: 77 22 8 537 510\*

(o) HP brake lever with remote adjustment (not shown)

Order number: 77 22 8 568 167\*

##### HP clutch lever

Order number: 77 22 8 537 509



### HP HANDBRAKE LEVER WITH REMOTE ADJUSTMENT, BLACK

#### AVAILABLE FOR

S 1000 RR  
Only for model codes 0507, 0517, 0524, 0534  
HP4

Successfully tested on the racetrack before market launch, the hand levers allow riders to adjust the distance between the handlebar grip and the hand lever itself. A roller wheel on the left handlebar allows adjustment of brake lever play when the bike's centre of pressure shifts. A folding mechanism reduces the danger of the lever bending or braking in the event of a crash.

To be fitted and/or enabled in a specialist workshop, and ideally at your BMW Motorrad dealership.

#### PART NUMBERS

##### HP brake lever in Black, with remote adjustment

Order number: 77 22 8 536 923\*

(+) HP clutch lever, Black

Order number: 77 22 8 544 058\*

(+) = "and" – this item must be ordered at the same time

(o) = "or" – this item may be ordered as an alternative option



### HP RIDER FOOT PEGS

#### AVAILABLE FOR

S 1000 R  
S 1000 RR

The high-quality CNC-milled HP rider foot pegs add both practicality and style. A variety of adjustment options for the foot pegs and brake/gear levers allow riders to create the ergonomic set-up that suits them best. Narrower foot pegs maximize the lean angle and are fixed – the preferred set-up in motorsport. Knurling ensures grip retention even in wet weather.

To be fitted and/or enabled in a specialist workshop, and ideally at your BMW Motorrad dealership.



#### PART NUMBERS: S 1000 R + S 1000 RR<sup>1</sup>

##### HP rider foot pegs (image 1)

Order number: 77 25 7 724 553\*

#### PART NUMBERS: S 1000 RR<sup>2</sup>

##### HP rider foot peg, left (image 2)

Order number: 77 25 8 550 773\*

(+) HP rider foot peg, right (image 3)

Order number: 77 25 8 550 774\*

(+) HP pillion passenger foot pegs

(see image, bottom left: HP rider foot pegs for S 1000 RR, S 1000 RR MÜ, S 1000 R)

Order number: 77 25 8 358 688\*

<sup>1</sup> Only for model codes 0507, 0517, 0524, 0534

<sup>2</sup> Only for model codes 0D10, 0D21



### HP PILLION PASSENGER FOOT PEGS

#### AVAILABLE FOR

S 1000 R  
S 1000 RR

The material, shape and colour of the HP pillion foot pegs match those of the HP rider foot pegs.



### HP FOOT PEG PLATE, RIGHT

#### AVAILABLE FOR

S 1000 R  
Only for model codes 0D02, 0D12

S 1000 RR

Only for model codes 0507, 0517

When the HP titanium exhaust system or the HP power kit are fitted, the fixing eyelet becomes redundant and can be removed to reduce the weight of the foot peg plate.

Only for track use (not homologated for road use). To be fitted and/or enabled in a specialist workshop, and ideally at your BMW Motorrad dealership.

Only in conjunction with HP rider foot pegs and HP titanium exhaust system/HP power kit.

#### PART NUMBER

##### HP foot peg plate, right

Order number: 77 25 8 532 040

#### PART NUMBER

##### HP pillion passenger foot pegs

Order number: 77 25 8 358 688

(o) HP pillion passenger foot pegs, Black

Order number: 77 25 2 452 955

\* Original BMW Motorrad equipment is available from your BMW Motorrad dealer.



### HP CHAIN TENSIONER

**AVAILABLE FOR**  
S 1000 R  
S 1000 RR  
HP4

Unlike the standard tensioner, the HP chain tensioner is firmly attached to the swing arm, which makes it easier to fit the rear wheel. Play-free adjustment of the chain in both directions makes it easier to move (particularly forward) than with the standard chain tensioner.

#### PART NUMBERS

**HP chain tensioner**  
Order number: 77 25 8 560 292  
**(o) HP workstand support** (not shown)  
Order number: 77 25 8 560 293



### HP ENGINE PROTECTORS

**AVAILABLE FOR**  
S 1000 R  
S 1000 RR  
HP4

These aluminium protectors are fitted with replaceable plastic sliders.

#### PART NUMBERS

**HP engine protector, left** (image 1)  
Order number: 77 25 8 545 293  
**(+)** HP engine protector, right (image 2)  
Order number: 77 25 8 545 292

### HP AXLE PROTECTORS

**AVAILABLE FOR**  
S 1000 R  
S 1000 RR  
HP4

These highly abrasion-resistant plastic drop-protection pads protect the fork and swing arm from damage.

#### PART NUMBER

**HP axle protectors** (one required per axle)  
Order number: 77 25 8 356 929



### HP HAND LEVER PROTECTORS

**AVAILABLE FOR**  
S 1000 R  
S 1000 RR  
Only for model codes 0D10, 0D21, 0D40

A curved bow made of aluminium and plastic that increases safety on the racetrack. Designated as mandatory by the FIM for all classes of Grand Prix motorcycle racing. Adds to the sport-bike look. Only available in conjunction with folding HP clutch lever.

#### PART NUMBERS: S 1000 R

**HP brake lever protector**  
Order number: 77 22 8 555 582  
**(o)** HP clutch lever protector  
Order number: 77 22 8 555 583

#### PART NUMBERS: S 1000 RR

**HP brake lever protector**  
Order number: 77 22 8 537 508  
**(o)** HP clutch lever protector  
Order number: 77 22 8 537 507

**(+)** = "and" – this item must be ordered at the same time  
**(o)** = "or" – this item may be ordered as an alternative option



### HP FORGED WHEELS

**AVAILABLE FOR**  
S 1000 R  
S 1000 RR  
HP4

Forged aluminium wheels are more stable and 2 kg lighter than the standard wheels, which significantly improves handling and suspension response. To be fitted and/or enabled in a specialist workshop, and ideally at your BMW Motorrad dealership.

#### PART NUMBERS

**HP forged wheel, front**  
Order number: 36 31 8 548 892  
**(+)** Brake disc with rivet (two required)  
Order number: 34 11 8 523 478  
**(+)** Cylinder screw (12 required)  
Order number: 07 12 9 907 382  
**(+)** Sensor ring  
Order number: 34 52 8 523 479  
**(+)** ISA screw (six required)  
Order number: 07 12 9 907 842  
**(+) HP forged wheel, rear**  
Order number: 36 31 8 548 893  
**(+)** Spacing bushing  
Order number: 33 81 8 523 331  
**(+)** Camshaft sprocket carrier  
Order number: 33 81 8 530 679  
**(+)** Damper (five required)  
Order number: 33 81 8 530 682  
**(+)** Camshaft sprocket  
Order number: 33 81 8 532 146  
**(+)** Fitting screw (five required)  
Order number: 33 81 8 532 733  
**(+)** Flange nut (five required)  
Order number: 27 71 7 724 142  
**(+)** Spacing bushing, outer  
Order number: 36 31 8 534 822

\* Original BMW Motorrad equipment is available from your BMW Motorrad dealer.



### HP CARBON WINDSHIELD

**AVAILABLE FOR**  
S 1000 R

#### PART NUMBERS

**HP carbon windshield**  
Order number: 77 31 8 559 259  
**(+)** Body panel screw with flange (three required)  
Order number: 46 63 8 521 655  
**(+)** Plastic washer  
Order number: 07 12 9 907 382



### HP CARBON FRONT MUDGUARD

**AVAILABLE FOR**  
S 1000 R  
S 1000 RR  
HP4

#### PART NUMBERS

**HP carbon front mudguard**  
Order number: 77 31 8 549 539  
**(+)** Body panel screw without flange (four required)  
Order number: 46 63 8 534 938  
**(+)** Plastic washer (four required)  
Order number: 46 63 7 714 241



### HP CARBON REAR MUDGUARD

**AVAILABLE FOR**  
S 1000 R  
S 1000 RR  
HP4

#### PART NUMBERS

**HP carbon rear mudguard**  
Order number: 71 60 7 721 216  
**(+)** Attachment for HP carbon rear mudguard  
Order number: 77 31 7 727 954



### HP CARBON BADGE CARRIER

**AVAILABLE FOR**  
S 1000 RR  
Only for model codes 0507, 0517, 0524, 0534  
HP4

#### PART NUMBER

**HP carbon badge carrier**  
Order number: 71 60 7 722 466  
**(+)** Spring nut (three required)  
Order number: 51 41 9 142 456



### HP CARBON UPPER FAIRING SIDE PANEL

**AVAILABLE FOR**  
S 1000 RR  
Only for model codes 0D10, 0D21

#### PART NUMBERS

##### HP carbon upper fairing side panel, left

Order number: 77 31 8 550 749  
(+) Body panel screw without flange (two required)  
Order number: 46 63 8 534 938  
(+) Plastic washer (42 required)  
Order number: 46 63 7 714 241

##### HP carbon upper fairing side panel, right

Order number: 77 31 8 550 748  
(+) Body panel screw without flange (two required)  
Order number: 46 63 8 534 938  
(+) Plastic washer (two required)  
Order number: 46 63 7 714 241



### HP CARBON SLIPSTREAM DEFLECTORS

**AVAILABLE FOR**  
S 1000 RR  
Only for model codes 0524, 0534  
HP4

#### PART NUMBER

**HP carbon slipstream deflectors**  
Order number: 77 31 8 528 448



### HP CARBON AIRBOX COVER

**AVAILABLE FOR**  
S 1000 R  
S 1000 RR  
Only for model codes 0D10, 0D21

#### PART NUMBERS

**HP carbon airbox cover**  
Order number: 77 31 8 537 855  
(+) Plastic washer (two required)  
Order number: 46 63 7 714 241  
(+) Body panel screw without flange (six required)  
Order number: 46 63 8 534 938  
(+) Body panel screw without flange  
Order number: 46 63 8 534 940

### HP CARBON CROSSBEAM (NOT SHOWN)

**AVAILABLE FOR**  
S 1000 R  
S 1000 RR  
HP4

The HP carbon crossbeam holds the silencer in place during solo riding.

#### PART NUMBERS: S 1000 R

**HP carbon crossbeam**  
Order number: 77 11 8 537 834\*  
Only available in conjunction with HP titanium exhaust system.  
(+) Cylinder screw (two required)  
Order number: 07 12 9 907 381

#### PART NUMBER: S 1000 RR<sup>1</sup>, HP4

**HP carbon crossbeam**  
Order number: 77 11 8 521 689\*  
Only in conjunction with HP titanium exhaust system/HP power kit.

#### PART NUMBERS: S 1000 RR<sup>2</sup>

**HP carbon crossbeam**  
Order number: 77 11 8 554 343\*  
Only in conjunction with HP titanium exhaust system/HP power kit/HP sport silencer.  
(+) Cylinder screw (two required)  
Order number: 07 12 9 907 381\*

<sup>1</sup> Only for model codes 0507, 0517, 0524, 0534  
<sup>2</sup> Only for model codes 0D10, 0D21, 0D40



### HP CARBON HEEL GUARDS

**AVAILABLE FOR**  
S 1000 RR

#### PART NUMBERS<sup>1</sup>

**HP carbon heel protector, left** (image 1)  
Order number: 71 60 7 722 381  
(+) HP carbon heel guard, right  
Order number: 71 60 7 722 382  
(+) ISA screw (two required)  
Order number: 07 12 9 904 588  
(+) Raised flange head screw (two required)  
Order number: 46 71 7 701 944

#### PART NUMBERS<sup>2</sup>

**HP carbon heel protector, left** (image 2)  
Part of the HP rider foot peg system.  
Order number: 77 25 8 546 531  
(+) HP carbon heel guard, right  
Order number: 77 25 8 546 530

<sup>1</sup> Only for model codes 0507, 0517, 0524, 0534  
<sup>2</sup> Only for model codes 0D10, 0D21



### HP CARBON TANK COVERS

**AVAILABLE FOR**  
S 1000 RR  
Only for model codes 0507, 0517, 0524, 0534  
HP4

#### PART NUMBER

**HP carbon tank cover**  
Order number: 71 60 7 722 465



### HP CARBON TANK COVERS

**AVAILABLE FOR**  
S 1000 R  
S 1000 RR  
Only for model codes 0D10, 0D21

#### PART NUMBERS

**HP carbon tank cover, left**  
Order number: 77 31 8 550 751  
(+) HP carbon tank cover, right  
Order number: 77 31 8 550 750\*



### HP CARBON SEAT HUMP COVER

**AVAILABLE FOR**  
S 1000 RR  
Only for model codes 0507, 0517, 0524, 0534  
HP4

#### PART NUMBERS

**HP carbon seat hump cover**  
Order number: 71 60 7 719 499  
(+) Attachment for seat hump cover  
Order number: 77 31 8 520 252  
(+) Locking cylinder for central locking with motorcycle  
Order number: 51 25 7 681 200





**HP CARBON ENGINE SPOILER**

**AVAILABLE FOR**  
S 1000 RR  
Only for model codes OD10, OD21

**PART NUMBERS**

**HP carbon engine spoiler**

Order number: 77 31 8 551 228

(+) Plastic washer (ten required)

Order number: 46 63 7 714 241

(+) Body panel screw without flange (ten required)

Order number: 46 63 8 534 938

**PART NUMBERS**

**HP carbon race engine spoiler**

Order number: 77 31 8 551 227

(+) Joint (two required)

Order number: 61 66 1 382 908

(+) Plastic washer (ten required)

Order number: 46 63 7 714 241

(+) C-clip nut, self-locking (two required)

Order number: 46 63 8 532 314

(+) Body panel screw without flange (ten required)

Order number: 46 63 8 534 938

(+) Rubber grommet (two required)

Order number: 31 42 1 232 245

(+) Fuel hose (two required)

Order number: 16 11 7 718 574

(+) Plug

Order number: 07 14 7 140 849



**HP CARBON ENGINE SPOILER, LONG**

**AVAILABLE FOR**  
HP4

**PART NUMBERS**

**HP carbon engine spoiler, long**

Order number: 46 63 8 531 281

(+) Engine spoiler mounting kit

Order number: 77 31 8 542 041

(+) Grommet

Order number: 62 21 7 670 749

(+) Rubber grommet

Order number: 62 11 7 663 112



**HP CARBON SPROCKET COVER**

**AVAILABLE FOR**  
S 1000 R  
S 1000 RR

**PART NUMBERS**

**HP carbon sprocket cover**

Order number: 77 31 8 555 880\*



**HP CARBON CHAIN GUARD**

**AVAILABLE FOR**  
S 1000 R  
S 1000 RR  
HP4

**PART NUMBERS**

**HP carbon chain guard**

Order number: 71 60 7 714 596

(+) Body panel screw without flange

Order number: 46 63 8 534 938

(+) Plastic washer

Order number: 46 63 7 714 241



**HP CARBON ENGINE SPOILER**

**AVAILABLE FOR**  
S 1000 RR  
Only for model codes 0507, 0517, 0524, 0534

**PART NUMBERS**

**HP carbon engine spoiler**

Order number: 71 60 7 722 464



\* Original BMW Motorrad equipment is available from your BMW Motorrad dealer.



(+) = "and" – this item must be ordered at the same time  
 (o) = "or" – this item may be ordered as an alternative option



**HP TYRE WARMERS**

**AVAILABLE FOR**

S 1000 RR  
 HP4

Patented carbon-fibre heating technology warms up the tyres quickly and evenly without damaging them.

**PART NUMBER**

**HP tyre warmers**  
 Order number: 77 02 8 543 059\*

**HP BRAKE BLEED ASSISTANT (NOT SHOWN)**

**AVAILABLE FOR**

S 1000 RR  
 Only for model codes 0507, 0517, 0524, 0534  
 HP4

**PART NUMBER**

**HP brake bleed assistant**  
 Order number: 77 02 8 536 259\*



**HP LAP TIMER**

**AVAILABLE FOR**

S 1000 R  
 S 1000 RR  
 HP4

For automatic logging of lap times on the racetrack, with precise breakdowns of individual laps.  
 Only for track use (not homologated for road use).

**PART NUMBER: HP4, S 1000 RR<sup>1</sup>**

**HP rider seat**  
 Order number: 77 34 8 543 056\*

**PART NUMBER: S 1000 R, S 1000 RR<sup>2</sup>**

**HP rider seat**  
 Order number: 77 34 8 546 602\*

<sup>1</sup> Only for model codes 0507, 0517, 0524, 0534  
<sup>2</sup> Only for model codes 0D10, 0D21

**HP RIDER SEAT**

**AVAILABLE FOR**

S 1000 R  
 S 1000 RR  
 HP4

Approx. 20 mm higher than the standard version, this seat is specially designed for track racing. A non-slip exterior plus the special contour of the seat ensure a better hold when accelerating, braking and cornering.

**PART NUMBER: HP4, S 1000 RR<sup>1</sup>**

**HP rider seat**  
 Order number: 77 34 8 543 056\*

**PART NUMBER: S 1000 R, S 1000 RR<sup>2</sup>**

**HP rider seat**  
 Order number: 77 34 8 546 602\*

<sup>1</sup> Only for model codes 0507, 0517, 0524, 0534  
<sup>2</sup> Only for model codes 0D10, 0D21

**PART NUMBER: HP4, S 1000 RR<sup>1</sup>**

**HP rider seat**  
 Order number: 77 34 8 543 056\*

**PART NUMBER: S 1000 R, S 1000 RR<sup>2</sup>**

**HP rider seat**  
 Order number: 77 34 8 546 602\*

<sup>1</sup> Only for model codes 0507, 0517, 0524, 0534  
<sup>2</sup> Only for model codes 0D10, 0D21



**HP COVER KIT**

**AVAILABLE FOR**

S 1000 R  
 S 1000 RR  
 HP4

The mirrors, front indicators and license plate holder (including rear indicator) are removed. On the S 1000 RR, covers replace all the removed parts. Only the license plate holder cover can be used on the S 1000 R.  
 Only for track use (not homologated for road use).  
 Only the license plate holder cover can be used on the S 1000 R.

**PART NUMBERS**

**HP cover kit**  
 Order number: 77 31 8 520 178\*  
 (+) Blind cap set for cable harness  
 Order number: 77 53 8 526 536\*  
 (+) Grommet  
 Order number: 62 21 7 670 749\*  
 (+) Raised head screw  
 Order number: 46 62 7 652 556\*  
 (+) Badge  
 Order number: 31 42 7 708 518\*

**PART NUMBERS**

**(+) HP infrared transmitter for lap timer**  
 Order number: 71 60 7 715 836\*  
**HP infrared receiver for lap timer**  
 Order number: 71 60 7 715 830\*

\* Original BMW Motorrad equipment is available from your BMW Motorrad dealer.



### HP BRAKE BLEED VALVES

**AVAILABLE FOR**

S 1000 RR  
Only for model codes 0507, 0517, 0524, 0534  
HP4

HP brake bleed valves prevent air from infiltrating the brake system, which makes changing brake fluid much easier.



### HP DATA LOGGER

**AVAILABLE FOR**

S 1000 R  
S 1000 RR  
HP4

Save and analyse ride data to improve lap times.  
Only for track use (not homologated for road use).

**PART NUMBER**

**HP data logger**  
Order number: 77 53 8 526 204\*

### HP BRAKE BLEED ASSISTANT (NOT SHOWN)

**AVAILABLE FOR**

S 1000 RR  
Only for model codes 0507, 0517, 0524, 0534  
HP4

**PART NUMBER: HP4**

**HP brake bleed valve**  
Order number: 77 02 8 536 257\*

**PART NUMBER: S 1000 RR**

**HP brake bleed valve**  
Order number: 77 02 8 543 065\*

**PART NUMBER**

**HP brake bleed assistant**  
Order number: 77 02 8 536 259\*

1



2



### HP RACE CALIBRATION KIT

**AVAILABLE FOR**

S 1000 RR  
Only for model codes 0524, 0534, 0D10, 0D21, 0D40  
HP4

Allows riders to customize a range of engine management parameters and fine-tune performance on the racetrack.

Only for track use (not homologated for road use).

**PART NUMBERS: HP4, S 1000 RR<sup>1</sup>**

**HP race calibration kit 2** (image 1)  
Order number: 77 53 8 544 507\*

(+) HP calibration kit enabling code (image 2)  
Order number: 13 61 8 542 056\*

**PART NUMBERS: S 1000 RR<sup>2</sup>**

**HP race calibration kit 3**  
Order number: 77 53 8 546 642\*

(+) HP calibration kit enabling code  
Order number: 13 61 8 542 056\*

<sup>1</sup> Only for model codes 0524, 0534

<sup>2</sup> Only for model codes 0D10, 0D21

(+) = "and" – this item must be ordered at the same time  
(o) = "or" – this item may be ordered as an alternative option



### HP GEAR-SHIFT ASSIST

**AVAILABLE FOR**

S 1000 R  
S 1000 RR  
Only for model codes 0507, 0517, 0524, 0534

Change gears like the pros on the track: the HP gear-shift assist minimizes shift times, and enables faster upshifts without throttle release or use of the clutch.

To be fitted and/or enabled in a specialist workshop, and ideally at your BMW Motorrad dealership.

**PART NUMBER**

**HP gear-shift assist**  
Order number: 77 25 8 528 774\*

**ALSO FOR S 1000 R**

(+) FSC gear-shift assist, retrofit  
Order number: 13 61 8 545 879\*

**ALSO FOR S 1000 RR**

(+) FSC gear-shift assist, retrofit  
Order number: 13 61 7 713 379\*



### PRO GEAR-SHIFT ASSIST (NOT SHOWN)

**AVAILABLE FOR**

S 1000 RR  
Only for model codes 0D10, 0D21

Enables gear shifts without the use of the clutch.

To be fitted and/or enabled in a specialist workshop, and ideally at your BMW Motorrad dealership.

For more detailed information, contact your BMW Motorrad dealership or go online at [bmw-motorrad.com](http://bmw-motorrad.com)

\* Original BMW Motorrad equipment is available from your BMW Motorrad dealer.



### HP SHIFT DIRECTION INVERSION

**AVAILABLE FOR**

S 1000 R  
S 1000 RR  
Only for model codes 0507, 0517, 0524, 0534

Shift direction inversion optimizes gear shifts on the racetrack.

Only for track use (not homologated for road use).

Only available in conjunction with HP rider foot pegs and HP gear-shift assist.

To be fitted and/or enabled in a specialist workshop, and ideally at your BMW Motorrad dealership.

For more detailed information, contact your BMW Motorrad dealership or go online at [bmw-motorrad.com](http://bmw-motorrad.com)

**PART NUMBER**

**HP shift direction inversion**  
Order number: 77 25 8 522 320\*

**PART NUMBERS**

**Pro gear-shift assist**  
Order number: 23 41 8 549 125\*

(+) FSC gear-shift assist, retrofit  
Order number: 13 61 8 545 879\*

(+) Micro switch  
Order number: 61 31 8 529 368\*

(+) Lever with intermediate plate  
Order number: 32 72 8 556 669\*

### HP CABLE HARNESS

**AVAILABLE FOR**

S 1000 RR  
Only for model codes 0507, 0517, 0524, 0534,

A lighter cable harness exclusively for racetrack use.  
To be fitted and/or enabled in a specialist workshop, and ideally at your BMW Motorrad dealership.

For more detailed information, contact your BMW Motorrad dealership or go online at [bmw-motorrad.com](http://bmw-motorrad.com)

Only for track use (not homologated for road use).

Only in conjunction with HP power kit.

**PART NUMBERS**

**HP cable harness**  
Order number: 77 50 8 544 504\*

## STORAGE



### BAG FOR PILLION SEAT

#### AVAILABLE FOR

S 1000 R  
S 1000 RR  
Only for model codes 0D10, 0D21 (RR)

Compact, sturdy and waterproof, this bag fixes snugly onto the pillion seat. 2.5l of storage space (expandable up to 5.5l) makes it just the right size for days out. Not available in conjunction with seat hump cover.

#### PART NUMBER

**Bag for pillion seat**  
Order number: 77 49 8 562 631\*



### SADDLE BAGS

#### AVAILABLE FOR

S 1000 R  
S 1000 RR  
Only for model codes 0524, 0534, 0D10, 0D21 (RR)

These fabric saddle bags with removable waterproof inner bags offer 10l of storage on each side, which can be expanded to 16l. Thanks to a quick-lock attachment system, loading and unloading is a breeze.

#### PART NUMBER

**Saddle bags**  
Order number: 77 40 2 446 914\*



### TANKBAG

#### AVAILABLE FOR

S 1000 R  
S 1000 RR  
Only for model codes 0D10, 0D21 (RR)

Tankbag with a waterproof main compartment (capacity approx. 13l) plus a waterproof map pocket and a small exterior pocket.

#### PART NUMBER

**Tankbag**  
Order number: 77 45 8 545 898\*

### TANKBAG

#### AVAILABLE FOR

S 1000 RR  
Only for model codes 0507, 0517, 0524, 0534  
HP4

Waterproof 5-l tankbag with a small map pocket and mobile-phone slot in the lid.

#### PART NUMBERS

**Tankbag**  
Order number: 77 49 7 726 105\*  
(+) Oval head screw  
Order number: 63 21 7 698 479\*  
(+) Raised head screw (two required)  
Order number: 06 32 7 657 966\*  
(+) Washer (three required)  
Order number: 07 11 9 904 446\*



(+) = "and" – this item must be ordered at the same time  
(o) = "or" – this item may be ordered as an alternative option

1



### REAR BAG

#### IMAGE 1 AVAILABLE FOR

S1000RR model codes 0524/0534

#### IMAGE 2 AVAILABLE FOR

S1000RR 0D10/0D21  
S1000R 0D02/0D12

Main compartment with variable capacity of approx. 22 to 26l. Splash-proof outer pockets at the sides and on the lid.

Not available in conjunction with comfort pillion seat.

Not available in conjunction with seat hump cover.

2



#### PART NUMBER: S 1000 RR, HP4

**Rear bag** (image 1)  
Order number: 77 49 8 533 749\*

#### PART NUMBER: S 1000 R, S 1000 RR

**Rear bag** (image 2)  
Order number: 77 49 8 545 894\*

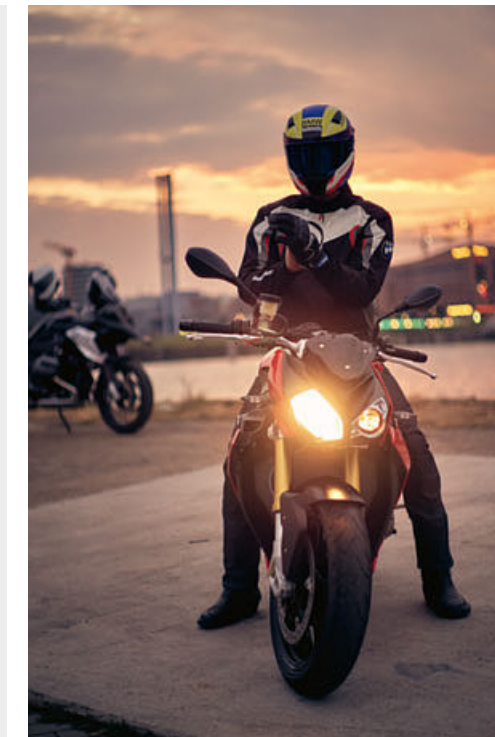

## DESIGN



### LED INDICATORS

#### AVAILABLE FOR

S 1000 R  
S 1000 RR

Cutting-edge design inside and out. The LED indicators deliver significantly longer bulb life – a shining example of efficiency.

#### PART NUMBER

**LED indicators** (four required)  
Order number: 63 13 8 522 503\*

#### PART NUMBER: S 1000 R, S 1000 RR

(+) LED indicator light mounting kit  
Order number: 77 51 8 551 391\*  
(Not for model codes 0507, 0517 (RR))

(+) LED indicator light mounting kit  
Order number: 77 51 7 728 072\*  
(Only for model codes 0507, 0517 (RR))

\* Original BMW Motorrad equipment is available from your BMW Motorrad dealer.

### SEAT HUMP COVER

**AVAILABLE FOR**

S 1000 R  
S 1000 RR

Mounted instead of the pillion seat, the seat hump cover adds an extra dash of style to the motorcycle.

**PART NUMBERS: S 1000 RR<sup>1</sup>**

**Seat hump cover, Neon Yellow Metallic**  
Order number: 71 60 8 520 000\*

**Seat hump cover, Thunder Grey Metallic**  
Order number: 71 60 7 723 332\*

**Seat hump cover, Acid Green Metallic**  
Order number: 71 60 7 723 331\*

**Seat hump cover, Mineral Silver Metallic**  
(image 1)  
Order number: 71 60 7 723 333\*

**Seat hump cover, Light Grey Metallic**  
Order number: 71 60 7 727 808\*

**PART NUMBERS: S 1000 RR<sup>2</sup>**

**Seat hump cover, Blue Fire** (image 2)  
Order number: 77 31 8 529 295\*

**Seat hump cover, Racing Red** (image 3)  
Order number: 77 31 8 529 294\*

**Seat hump cover, Granite Grey Matt Metallic**  
Order number: 77 31 7 721 705\*

**Seat hump cover, Sapphire Black Metallic**  
Order number: 77 31 8 529 296\*

**PART NUMBERS: S 1000 RR<sup>3</sup>**

**Seat hump cover, Alpine White**  
Order number: 71 60 7 723 330\*

**Primed seat hump cover**  
Order number: 77 31 8 527 726\*

**PART NUMBERS: S 1000 R, S 1000 RR<sup>4</sup>**

**Seat hump cover, Light White**  
Order number: 77 31 8 556 213\*

**Seat hump cover, Black Storm Metallic**  
Order number: 77 31 8 556 218\*

**Seat hump cover, Racing Red** (image 4)  
Order number: 77 31 8 556 214\*

**Seat hump cover, Frozen Dark Blue Metallic**  
Order number: 77 31 8 556 215\*

**ALSO FOR S 1000 R, S 1000 RR<sup>3</sup>**

(+) Seat hump cover mounting kit  
Order number: 77 31 8 520 252\*

(+) Locking cylinder with VIN code  
Order number: 51 25 7 681 200\*

<sup>1</sup> Only for model codes 0507, 0517

<sup>2</sup> Only for model codes 0524, 0534

<sup>3</sup> Only for model codes 0507, 0517, 0524, 0534

<sup>4</sup> Only for model codes 0D10, 0D21

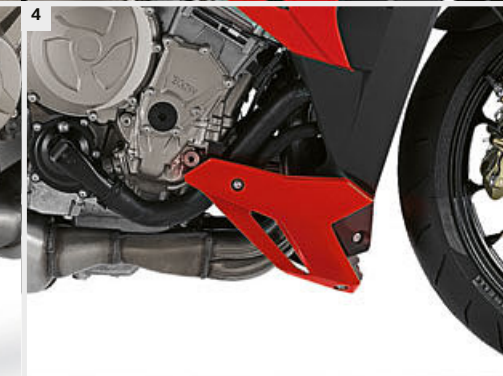
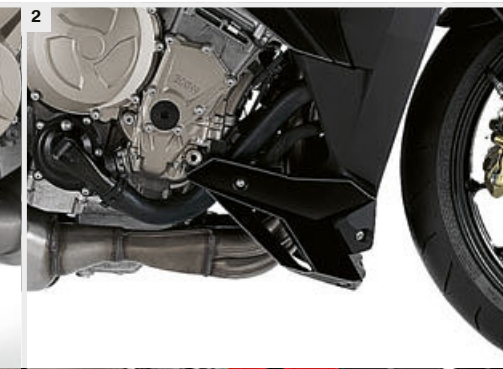
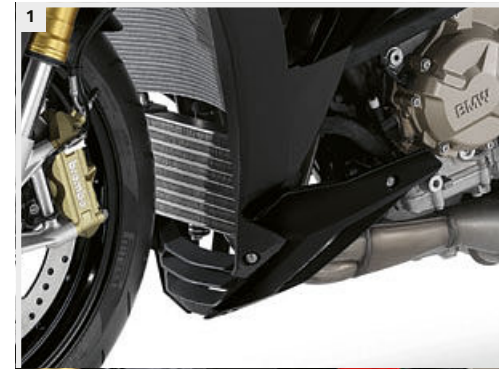
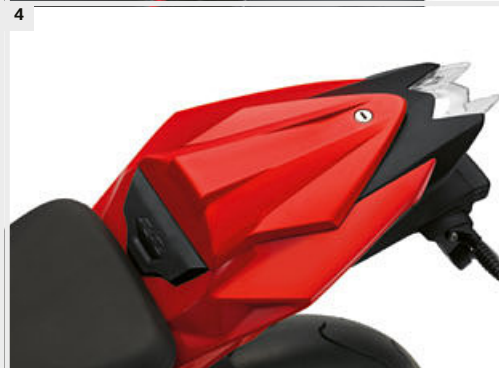

### ENGINE SPOILER

**AVAILABLE FOR**

S 1000 R

**PART NUMBERS**

**Engine spoiler, Black Storm Metallic, left**  
(image 1)  
Order number: 46 63 8 542 627\*

**Engine spoiler in Black Storm Metallic, right** (image 2)  
Order number: 46 63 8 542 628\*

**Engine spoiler, Light White, left**  
Order number: 46 63 8 549 523\*

**Engine spoiler, Light White, right**  
Order number: 46 63 8 549 524\*

**Engine spoiler, Racing Red, left** (image 3)  
Order number: 46 63 8 549 525\*

**Engine spoiler, Racing Red, right** (image 4)  
Order number: 46 63 8 549 526\*

**Engine spoiler, Frozen Dark Blue Metallic, left**  
(image 5)  
Order number: 46 63 8 549 527\*

**Engine spoiler, Frozen Dark Blue Metallic, right**  
(image 6)  
Order number: 46 63 8 549 528\*

(+) Engine spoiler  
Order number: 77 31 8 550 977\*

(+) Engine spoiler heat shield (two required)  
Order number: 77 31 8 553 713\*

(+) Bushing (two required)  
Order number: 72 11 7 119 896\*

## ERGONOMICS & COMFORT

### TINTED WINDSHIELD

**AVAILABLE FOR**  
S 1000 RR  
HP4

The tinted windshield gives the bike a sportier look. Same design and size as the clear windshield.

**PART NUMBER: S 1000 RR<sup>1</sup>**

**Tinted windshield**  
Order number: 77 33 7 728 008\*

**PART NUMBER: HP4, S 1000 RR<sup>2</sup>**

**Tinted windshield** (image 1)  
Order number: 77 33 8 522 258\*

**PART NUMBER: S 1000 RR<sup>3</sup>**

**Tinted windshield** (image 2)  
Order number: 46 63 8 540 846\*

<sup>1</sup> Only for model codes 0507, 0517

<sup>2</sup> Only for model codes 0524, 0534

<sup>3</sup> Only for model codes 0D10, 0D21



### HIGH WINDSHIELD

**AVAILABLE FOR**  
S 1000 RR  
HP4

The track-inspired, bubble-shaped high windshield makes all the difference at high speeds. Available either tinted or clear.

**PART NUMBERS: HP4, S 1000 RR<sup>1</sup>**

**High windshield** (image 1)  
Order number: 77 33 7 719 810\*

**High windshield, tinted** (image 2)  
Order number: 77 33 7 719 839\*

**PART NUMBERS: S 1000 RR<sup>2</sup>**

**High windshield** (image 3)  
Order number: 77 33 8 550 074\*

**High windshield, tinted** (image 4)  
Order number: 77 33 8 550 075\*

<sup>1</sup> Only for model codes 0507, 0517, 0524, 0534

<sup>2</sup> Only for model codes 0D10, 0D21

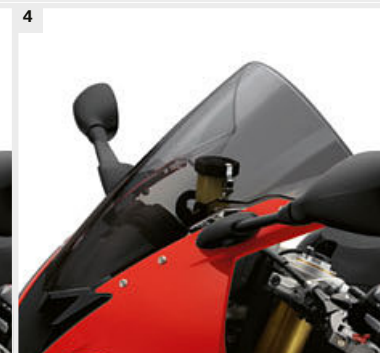
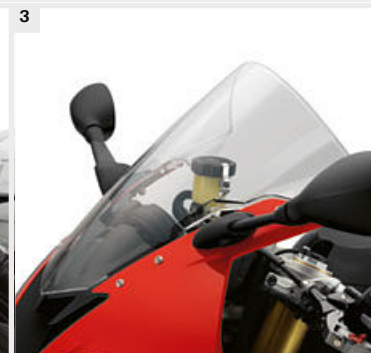

### SPORT WINDSHIELD, TINTED

**AVAILABLE FOR**  
S 1000 R

The sport windshield improves protection from the elements. To be fitted and/or enabled in a specialist workshop, and ideally at your BMW Motorrad dealership.

**PART NUMBER**

**Sport windshield, tinted**  
Order number: 46 63 8 546 224\*



### PILLION COMFORT SEAT

**AVAILABLE FOR**  
S 1000 R  
S 1000 RR  
Only for model codes 0524, 0534, 0D10, 0D21  
HP4

Extra padding and a wider seating area increase comfort for the pillion passenger.

**PART NUMBER**

**Pillion comfort seat**  
Order number: 77 34 8 549 541\*  
(+) Locking cylinder with VIN code  
Order number: 51 25 7 681 200\*



### COMFORT SEAT

**AVAILABLE FOR**  
S 1000 R  
S 1000 RR  
Only for model codes 0524, 0534, 0D10, 0D21  
HP4

Extra comfort for the rider and a stylish tricoloured design.

**PART NUMBER**

**Comfort seat**  
Order number: 77 34 8 544 942\*

### HEATED GRIPS (NOT SHOWN)

**AVAILABLE FOR**  
S 1000 R  
S 1000 RR

Only for model codes 0524, 0534, 0D10, 0D21

Keep your hands as warm as you like with retrofittable heated grips.

To be fitted and/or enabled in a specialist workshop, and ideally at your BMW Motorrad dealership.

For more detailed information, contact your BMW Motorrad dealership or go online at [bmw-motorrad.com](http://bmw-motorrad.com)

**PART NUMBERS: S 1000 RR**

**Heated grip, left**  
Order number: 61 31 7 708 227\*

**Heated grip, right**  
Order number: 61 31 8 522 476\*

(+) Raised head screw with flange  
Order number: 61 31 7 682 091\*

(+) Raised countersunk screw (two required)  
Order number: 07 11 9 906 567\*

(+) Multifunction switch, right  
Order number: 61 31 8 546 176\*

(+) Multifunction switch cover, right  
Order number: 61 31 7 708 233\*

**PART NUMBERS: S 1000 R, S 1000 RR**

**Heated grip, left**  
Order number: 61 31 7 727 065\*

**Heated grip for vehicles fitted with cruise control, right**  
Order number: 61 31 8 534 424\*

**Heated grip for vehicles without cruise control, right**  
Order number: 61 31 8 534 422\*

(+) Multifunction switch, right  
Order number: 61 31 8 567 720\*

### CRUISE CONTROL RETROFIT (NOT SHOWN)

**AVAILABLE FOR**  
S 1000 R  
S 1000 RR

Only for model codes 0D10, 0D21

For more detailed information, contact your BMW Motorrad dealership or go online at [bmw-motorrad.com](http://bmw-motorrad.com)

To be fitted and/or enabled in a specialist workshop, and ideally at your BMW Motorrad dealership.

## NAVIGATION



### BMW MOTORRAD NAVIGATION SYSTEMS

**AVAILABLE FOR**  
S 1000 R

Where am I? Where do I want to go, and what's the most scenic way to get there?

BMW Motorrad navigation devices show you where to go. Made specifically for motorcyclists, they're easy to fit and use – even with gloves on – and come with lifetime map updates.

The new BMW Motorrad Navigator VI is your ticket to the tour of your dreams. A whole new level of adventure awaits thanks to the “winding roads” route option, “avoid motorways” feature and the “round trip” function, which configures journeys based on time, distance or stopover. The circular polarization filter (CPOL) on the display minimizes reflection and improves contrast, ensuring the screen is easy to read, even in direct sunlight. 16 GB of flash storage, and the ability to stream music from your smartphone, are the ultimate luxury.

Thanks to Bluetooth® technology, the sophisticated BMW Motorrad Navigator Street (with easy-to-read 4.3" display) is compatible with the optional BMW Motorrad communication system and comes with a host of handy features.

BMW Motorrad navigation devices and the BMW Motorrad smartphone cradle can only be mounted using the BMW Motorrad navigation device bracket.

For more detailed information, contact your BMW Motorrad dealership or go online at [bmw-motorrad.com](http://bmw-motorrad.com)

Please note the specifications for different countries.

#### PART NUMBERS

**BMW Motorrad Navigator VI (EU)** (image 1)  
(with map data for Europe) (see image, right)  
Order number: Order number: 77 52 8 355 749\*

**BMW Motorrad Navigator VI (US)** (image 1)  
Order number: Order number: 77 52 8 355 829\*

**BMW Motorrad Navigator Street (EU)** (image 2)  
Order number: 77 52 8 557 855\*

**BMW Motorrad Navigator Street (US)** (image 2)  
Order number: 77 52 8 557 856\*

**BMW Motorrad smartphone cradle**(image 3)  
Order number: 77 52 8 563 125\*

### BRACKET FOR BMW MOTORRAD NAVIGATION DEVICES

**AVAILABLE FOR**  
S 1000 R

Bracket for mounting BMW Motorrad navigation devices  
Guarantees a good view of the navigation system.

To be fitted and/or enabled in a specialist workshop, and ideally at your BMW Motorrad dealership.

#### PART NUMBER

**Bracket for BMW Motorrad navigation devices**  
Order number: 77 52 7 724 487\*

(+) Screw (four required)  
Order number: 32 71 7 652 161\*



## SAFETY

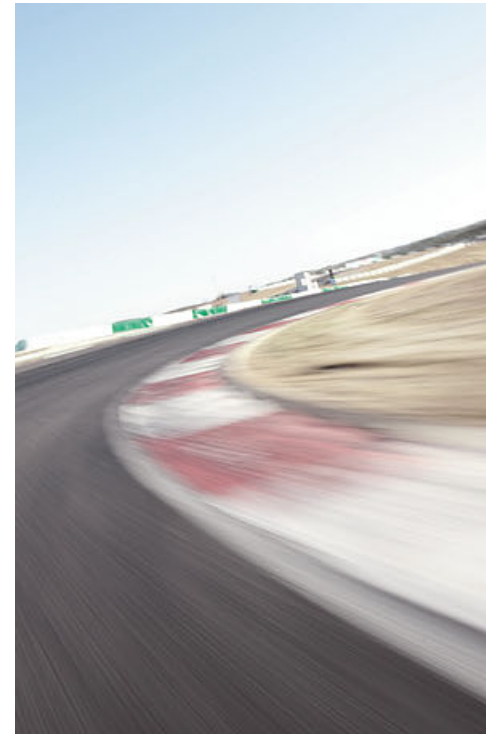

### ANTI-THEFT ALARM SYSTEM RETROFIT

**AVAILABLE FOR**  
S 1000 R  
S 1000 RR  
HP4

If the motorcycle is moved or struck violently, the system responds with a clearly audible signal and a flashing warning light.

To be fitted and/or enabled in a specialist workshop, and ideally at your BMW Motorrad dealership.

#### PART NUMBERS: S 1000 RR<sup>1</sup>, HP4

**Anti-theft alarm system retrofit**  
Order number: 77 53 8 545 003\*

(+) Bracket  
Order number: 65 75 7 713 681\*

(+) Resistor  
Order number: 61 13 7 668 405\*

#### PART NUMBER: S 1000 R, S 1000 RR<sup>2</sup>

**Anti-theft alarm system retrofit**  
Order number: 77 53 8 554 348\*

(+) Bracket  
Order number: 65 75 8 524 382\*

(+) Expanding rivet (two required)  
Order number: 51 49 7 054 361\*

(+) Cross-head screw for plastic  
Order number: 51 13 1 960 840\*

(+) AGM battery  
Order number: 61 21 7 726 563\*

<sup>1</sup> Only for model codes 0507, 0517, 0524, 0534

<sup>2</sup> Only for model codes 0D10, 0D21, 0D40

### ABS PRO, RETROFIT (NOT SHOWN)

**AVAILABLE FOR**

S 1000 R  
S 1000 RR  
Only for model codes 0524, 0534, 0D10, 0D21

HP4

To be fitted and/or enabled in a specialist workshop, and ideally at your BMW Motorrad dealership.

For more detailed information, contact your BMW Motorrad dealership or go online at [bmw-motorrad.com](http://bmw-motorrad.com).



**WE WORK WITH  
PRECISION.  
YOU RIDE WITHOUT  
COMPROMISE.  
THE BMW MOTORRAD SERVICE.**

You own an extraordinary motorcycle. Why would you take it to an ordinary garage? No matter the age of your machine, our mechanics know it inside out. They live and breathe BMW bikes, and they'll do whatever is necessary to get yours in top condition. So riding your bike will feel as much fun as the day you bought it. Find out more at [bmw-motorrad.com/service](http://bmw-motorrad.com/service)

**MAKE LIFE A RIDE.**





Subject to change in design and equipment. Subject to error. Vehicle illustrations may feature unspecified optional equipment. © BMW Motorrad, UX-VB-1, Munich, Germany. Not to be reproduced, wholly or in part, without the written permission of BMW AG, Munich. Printed on 100% chlorine-free bleached paper. Printed in Germany 07/2018.